

<p>CEMP-R/ CECW-E</p> <p>Engineer Manual 1110-1-502</p>	<p>Department of the Army U.S. Army Corps of Engineers Washington, DC 20314-1000</p>	<p>EM 1110-1-502</p> <p>30 April 1994</p>
	<p>Engineering and Design</p> <p>TECHNICAL GUIDELINES FOR HAZARDOUS AND TOXIC WASTE TREATMENT AND CLEANUP ACTIVITIES</p>	
	<p>Distribution Restriction Statement Approved for public release; distribution is unlimited.</p>	



EM 1110-1-502
30 April 1994

US Army Corps
of Engineers

ENGINEERING AND DESIGN

Technical Guidelines for Hazardous and Toxic Waste Treatment and Cleanup Activities

ENGINEER MANUAL

CEMP-R
CECW-E

DEPARTMENT OF THE ARMY
U.S. Army Corps of Engineers
Washington, DC 20314-1000

EM 1110-1-502

Manual
No. 1110-1-502

30 April 1994

Engineering and Design
TECHNICAL GUIDELINES FOR HAZARDOUS AND TOXIC WASTE TREATMENT
AND CLEANUP ACTIVITIES

1. Purpose. This manual provides design guidelines that will aid U.S. Army Corps of Engineers Districts and Divisions in the selection of remedial actions at uncontrolled hazardous waste sites. These guidelines are to be used in support of the Department of Defense Environmental Restoration Program (DERP), the Formerly Used Defense Sites (FUDS) Program, Resources Conservation and Recovery Act (RCRA), support to U.S. Environmental Protection Agency (EPA) activities associated with the Comprehensive Environmental Response, Compensation, and Liability Act (CERCLA), and the remediation of hazardous waste contamination at Civil Works sites.
2. Applicability. This manual applies to those major subordinate commands and USACE districts assigned missions in support of the Nation's efforts to remediate uncontrolled hazardous waste releases.
3. General. This manual presents guidance for the design of remedial and corrective actions at hazardous waste sites. The guidance includes information on site-specific remedial technologies, including containment, treatment, and disposal systems. Information is also provided to aid in the performance of preliminary assessments, site investigations, remedial investigations, and feasibility studies in support of the Installation Restoration Program, FUDS, CERCLA, RCRA, and DERP.

FOR THE COMMANDER:

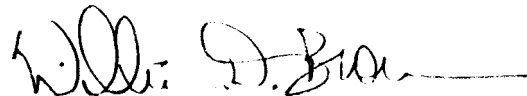

WILLIAM D. BROWN
Colonel, Corps of Engineers
Chief of Staff

Engineering and Design
TECHNICAL GUIDELINES FOR HAZARDOUS AND TOXIC WASTE TREATMENT
AND CLEANUP ACTIVITIES

Table of Contents

	<u>Subject</u>	<u>Paragraph</u>	<u>Page</u>
CHAPTER 1.	INTRODUCTION		
	Purpose	1-1	1-1
	Applicability	1-2	1-1
	References	1-3	1-1
	Explanation of Abbreviations and Terms	1-4	1-1
	USAGE Responsibilities	1-5	1-1
	Safety	1-6	1-3
CHAPTER 2.	IDENTIFICATION AND SELECTION OF REMEDIAL ACTION/CORRECTIVE MEASURE ALTERNATIVES		
Section I.	Introduction		
	Three-Step Approach	2-1	2-1
	Guidance	2-2	2-5
	RI/FS Procedure	2-3	2-5
Section II.	Determining the Nature and Extent of Contamination		
	Existing Site Conditions	2-4	2-10
	Scoping	2-5	2-10
	Site Characterization	2-6	2-12
	Health and Safety Considerations	2-7	2-13
	Data Base Requirements	2-8	2-16
	Data Base Development	2-9	2-21
	Community Relations During Site Characterization	2-10	2-24
	Extent of Hazard	2-11	2-26
Section III.	Establishment of Cleanup Criteria		
	Limits of Allowable Contamination Onsite and Offsite	2-12	2-26
	Cleanup Standards	2-13	2-27
	Applicable or Relevant and Appropriate Requirements	2-14	2-27

	<u>Subject</u>	<u>Paragraph</u>	<u>Page</u>
	Risk Assessment	2-15	2-28
	Technological Limitations on Cleanup . . .	2-16	2-34
Section IV.	Alternative Development and Screening		
	Developing Options	2-17	2-34
	Alternative Development Process	2-18	2-35
	Alternative Screening Evaluation	2-19	2-64
	Alternative Screening	2-20	2-68
	Treatability Investigations	2-21	2-69
Section V.	Detailed Analysis of Alternatives		
	Background	2-22	2-71
	Overview of Evaluation Criteria	2-23	2-72
	Discussion of Evaluation Factors	2-24	2-74
	Presentation of Individual Analyses	2-25	2-85
	Comparative Analysis of Alternatives . . .	2-26	2-86
	Presentation of Comparative Analysis . . .	2-27	2-87
	Post-RI/FS Selection of the Preferred Alternative	2-28	2-87
	Community Relations During Detailed Analysis	2-29	2-87
	Removal Activities	2-30	2-88
	Time-Critical Removal Actions	2-31	2-88
	Non-Time-Critical Removal Actions	2-32	2-91
	Removal Action Process	2-33	2-91
CHAPTER 3.	CONTROL AND CONTAINMENT TECHNOLOGIES		
	Definition	3-1	3-1
	Applicability	3-2	3-1
	Techniques	3-3	3-1
Section I.	Waste Collection and Removal		
	Drum Handling	3-4	3-1
	Storage	3-5	3-6
	Tank Cleaning and Demolition	3-6	3-15
	Lagoon Management	3-7	3-16
	Excavation of Landfills and Contaminated Soils	3-8	3-17
	Removal of Contaminated Sediments	3-9	3-19
	Decontamination of Structures	3-10	3-32
	Decontamination of Miscellaneous Media .	3-11	3-37
Section II.	Contaminated Ground-Water Plume Management		
	Ground-Water Pumping Systems	3-12	3-38
	Wellpoint Systems	3-13	3-38

	<u>Subject</u>	<u>Paragraph</u>	<u>Page</u>
	Extraction/Injection Well Systems	3-14	3-43
	Subsurface Barriers	3-15	3-47
	Slurry-trench Cutoff Walls	3-16	3-47
	Grout Curtains	3-17	3-51
	Sheet Pile Cutoff Walls	3-18	3-56
	Membranes and Synthetic Sheet Curtains . . .	3-19	3-58
	Combination Barrier/Pump Systems	3-20	3-59
	Subsurface Drains and Drainage Ditches . . .	3-21	3-59
Section III.	Surface Water Controls		
	Surface Water Diversion	3-22	3-66
	Surface Grading	3-23	3-83
	Surface Sealing	3-24	3-85
	Revegetation	3-25	3-94
Section IV.	Gas Control		
	Gas Generation and Migration	3-26	3-97
	Passive Gas Control Systems	3-27	3-100
	Active Control Systems	3-28	3-103
CHAPTER 4.	TREATMENT TECHNOLOGIES		
	Applicability	4-1	4-1
	Techniques	4-2	4-1
Section I.	Treatment of Liquid Waste Streams		
	Definitions	4-3	4-1
	Air Stripping	4-4	4-1
	Biological Treatment	4-5	4-6
	Carbon Adsorption	4-6	4-26
	Chemical Oxidation	4-7	4-34
	Resin Adsorption	4-8	4-42
	Chemical Reduction	4-9	4-48
	Precipitation	4-10	4-50
	Flocculation and Sedimentation	4-11	4-54
	Neutralization	4-12	4-59
	Oil-Water Separation	4-13	4-61
	Dissolved Air Flotation	4-14	4-63
	Reverse Osmosis	4-15	4-66
	Solidification/Stabilization	4-16	4-70
	Ultrafiltration	4-17	4-70
Section II.	Treatment of Sludges and Soils		
	Biological Treatment	4-18	4-74
	Encapsulation	4-19	4-82
	Low Temperature Thermal Desorption	4-20	4-85

	<u>Subject</u>	<u>Paragraph</u>	<u>Page</u>
	Solidification/Stabilization	4-21	4-88
	Thermal Destruction	4-22	4-93
	Volume Reduction	4-23	4-98
	Wet Oxidation	4-24	4-99
	Evaporation	4-25	4-103
Section III.	In Situ Treatment Technologies		
	Biological Treatment	4-26	4-107
	Chemical Oxidation	4-27	4-108
	Permeable Treatment Beds	4-28	4-109
	Soil Flushing	4-29	4-112
	Vapor Extraction	4-30	4-112
CHAPTER V.	DISPOSAL TECHNOLOGIES		
	Definition	5-1	5-1
	Applicability	5-2	5-1
	Techniques	5-3	5-1
	Regulatory Constraints	5-4	5-1
Section I.	Onsite Disposal		
	General	5-5	5-2
	Landfills	5-6	5-2
	Deep Well Injection	5-7	5-9
Section II.	Offsite Disposal		
	General	5-8	5-13
	Landfills	5-9	5-13
	Deep Well Injection	5-10	5-16
APPENDIX A.	REFERENCES		A-1
APPENDIX B.	MODEL STATEMENT OF WORK FOR CONDUCTING A RI/FS		B-1
APPENDIX C.	GLOSSARY		C-1

	<u>Title</u>	<u>Page</u>
Figure	2-1. Comparison of RCRA/CERCLA Action Processes .	2-2
	2-2. Remedial Action Evaluation Process	2-3
	2-3. Overview of the RI/FS Process	2-4
	2-4. Scoping the RI/FS Process	2-6
	2-5. Overview of Site Characterization Process . .	2-7
	2-6. Overview of the Development and Screening Alternatives Process	2-8
	2-7. Overview of the Detailed Analysis of Alternatives Process	2-10
	2-8. Dispersal Pathways for Contaminants	2-17
	2-9. Topic Areas for the Hazardous Substance Site Assessment	2-18
	2-10. Overview of the Risk Assessment Process . . .	2-30
	2-11. Identification of Exposure Pathways	2-32
	2-12. Alternative Development and Screening . . .	2-40
	2-13. Relationship Between Screening Criteria and Detailed Evaluation	2-66
	2-14. Detailed Analysis of Alternatives	2-75
	2-15. Typical Flow Chart For Time-Critical/Non-Time- Critical Removals	2-89
	2-16. General Elements of a Typical Time-Critical Removal Action	2-90
	2-17. General Elements of a Typical Non-Time-Critical Removal Action	2-91
	3-1. Organization of the Waste Site Cleanup Area	3-2
	3-2. Base Liner Details for Waste Piles	3-10
	3-3. Base Liner Details for Surface Impoundments	3-14
	3-4. Standard Cutter Assembly, Spiral Basket Cutter	3-21
	3-5. Standard Cutterhead Dredge Operation	3-22
	3-6. Standard Cutterhead Dredge Vessel	3-22
	3-7. Views of the Mud Cat MC-915 Dredge	3-23
	3-8. The Japanese Suction Dredge "Clean Up"	3-24
	3-9. Portable Centrifugal Pump System for Lagoon Dredging	3-25
	3-10. Streamflow Diversion for Sediment Excavation Using Two Cofferdams and Diversion Channel	3-27
	3-11. Streamflow Diversion for Sediment Excavation Using Single Cofferdam	3-28
	3-12. Construction of a Typical Center Tension Silt Curtain Section	3-29
	3-13. Typical Silt Curtain Deployment Configurations	3-30
	3-14. Flow Diagram for Developing a Structural Decontamination Strategy	3-36

	<u>Title</u>	<u>Page</u>
3-15.	Schematic of a Wellpoint Dewatering System	3-39
3-16.	Hydraulic Conductivities of Soil and Rock	3-40
3-17.	Use of Extraction/Injection Wells for Plume Containment	3-44
3-18.	Effect of an Injection Well on the Cone of Depression	3-46
3-19.	Design Drawing for Lipari Landfill Slurry-Trench Cutoff Wall	3-50
3-20.	Grout Pipe Layout for Grout Curtain	3-54
3-21.	Semicircular Grout Curtain Around Waste Site	3-54
3-22.	Subsurface Leachate Collection	3-61
3-23.	Typical Design Plan for Leachate Collection Systems	3-62
3-24.	Leachate Collection System for Love Canal, Transverse View	3-64
3-25.	Effect of Drainage Ditch on Velocity	3-70
3-26.	General Design Features of Diversions	3-71
3-27.	Typical Drainage Bench	3-74
3-28.	Typical Levee at Base of Disposal Site	3-78
3-29.	Some Typical Floodwall Sections	3-79
3-30.	Seepage Basin: Large Volume, Deep Depth to Ground Water	3-81
3-31.	Seepage Basin: Shallow Depth to Ground Water	3-81
3-32.	Seepage Ditch	3-81
3-33.	Typical Design of a Sediment Basin Embankment	3-83
3-34.	Landfill Gas Composition Transition	3-98
3-35.	Design Configuration of Pipe Vents	3-100
3-36.	Design Configuration of Trench Vents	3-102
3-37.	Forced-Ventilation System for Landfill Gas Control	3-105
4-1.	Ammonia Stripping Lagoon	4-2
4-2.	Ammonia Stripping Tower	4-3
4-3.	Ammonia Stripper and Recovery System	4-6
4-4.	Typical Activated Sludge System	4-11
4-5.	Trickling Filter Recirculation	4-17
4-6.	Rotating Biological Disk Treatment Schematic	4-21
4-7.	Aerated Lagoon (Polymeric-Lined Earth Construction)	4-23
4-8.	Most Common Configuration of Activated Carbon Adsorber Systems	4-33
4-9.	Process Flow Diagram with Upflow Carbon Contactors and Regeneration	4-33
4-10.	Phenol Recovery System Using Acetone Regenerant	4-43

<u>Title</u>	<u>Page</u>
4-11. Chlorinated Hydrocarbon Recovery System Using Steam Regenerant	4-44
4-12. Solubility of Metal Hydroxides and Sulfides	4-52
4-13. Representative Configuration Employing Precipitation, Flocculation, and Sedimentation	4-58
4-14. Typical Solids Contact Chemical Treatment System	4-58
4-15. Flow Diagram for API Separator	4-61
4-16. Flow Diagram for Dissolved Air Flotation System	4-64
4-17. Reverse Osmosis Plant Flow Sheet	4-68
4-18. Effect of Concentration Polarization Upon Membrane Flux in Ultrafiltration	4-71
4-19. Typical Bioslurry Treatment System	4-75
4-20. Typical Composting Systems	4-79
4-21. Encapsulation Process Concept	4-84
4-22. Schematic Diagram of a Low Temperature Thermal Treatment System	4-86
4-23. Steps in Stabilization/Solidification of Hazardous Wastes	4-89
4-24. EPA Mobile Incineration System	4-96
4-25. Flow Sheet of Wet Air Oxidation	4-100
4-26. Oxidation Curves for Five Aqueous Fuels	4-101
4-27. Three-Effect Evaporator	4-105
4-28. Cross Section of Landfill Treated by Chemical Injection	4-109
4-29. Installation of a Permeable Treatment Bed	4-110
4-30. Soil Vapor Extraction System	4-113
5-1. Cross Section of Chemical Waste Landfill with Leachate Collection	5-4
5-2. Deep Injection Well	5-11

	<u>Title</u>	<u>Page</u>
Table 2-1.	CERCLA/RCRA Terminology Crosswalk	2-3
2-2.	Checklist of Major Features Included in Site Description	2-14
2-3.	Critical Areas in Evaluation of Site Data from Preliminary Assessment	2-16
2-4.	Typical Number of Samples to be Collected for Different Informational Requirements	2-19
2-5.	Sources of Data for Site Assessment	2-22
2-6.	Example of Data Quality Variation in a Selected Number of Parameters Used in Hydrologic Simulational Models	2-23
2-7.	Examples of Typical Data Required to Assess Vapor Movement through a Soil Cover	2-23
2-8.	Outline of Suggested File Structure for Superfund Sites	2-25
2-9.	Important Site Characteristics and Considera- tions Affecting Selection of Remedial Measures	2-37
2-10.	Example of Remedial Action Objectives, General Response Actions, Technology Types, and Example Process Options for the Development and Screening of Technologies	2-41
2-11.	Summary of Available Remedial Action Tech- niques for Contaminated Surface Flows	2-52
2-12.	Summary of Available Remedial Action Tech- niques for Contaminated Ground Water	2-54
2-13.	Summary of Available Remedial Action Tech- niques for Contaminated Air/Soil Pore Spaces	2-57
2-14.	Summary of Available Remedial Action Tech- niques for Contaminated Soil and Sediments	2-58
2-15.	Summary of Available Remedial Action Tech- niques for Hazardous Wastes	2-60
2-16.	Summary of Available Remedial Action Tech- niques for Contaminated Water and Sewer Lines	2-62
2-17.	Bench and Pilot Study Parameters	2-70
2-18.	Long-Term Effectiveness and Permanence	2-77
2-19.	Reduction of Toxicity, Mobility, or Volume through Treatment	2-78
2-20.	Short-Term Effectiveness	2-80
2-21.	Implementability	2-81
2-22.	Key Steps in the EE/CA Process	2-93
2-23.	Outline and Contents of the EE/CA	2-94
3-1.	Measures for Minimizing Contaminant Releases during Drum Handling	3-4
3-2.	Summary of Liner Types	3-8
3-3.	Examples of Potentially Incompatible Wastes	3-12
3-4.	Liquid Waste Removal Methods for Surface Impoundments	3-15

	<u>Title</u>	<u>Page</u>
3-5.	Significant Characteristics of Types of Grout	3-52
3-6.	Permissible Design Velocities for Stabilized Diversions and Waterways	3-71
3-7.	Summary of Chemical Stabilizers for Cover Soil	3-89
4-1.	Summary of Biological Treatment Processes .	4-7
4-2.	Summary of Operating Parameters for Air- Activated Sludge and Pure-Oxygen-Activated Sludge	4-14
4-3.	Design Criteria for Trickling Filters . . .	4-19
4-4.	Design Criteria for Waste Stabilization Ponds	4-25
4-5.	Effects of Molecular Structures and Other Factors on Adsorption by Activated Carbon	4-28
4-6.	Potential for Removal of Inorganic Material by Activated Carbon	4-29
4-7.	Summary of Activated Carbon Contacting Methods	4-32
4-8.	Operating Parameters for Carbon Adsorption .	4-34
4-9.	Resistance of Selected Species to Ozone Oxidation	4-36
4-10.	COD Reduction by Ozone	4-37
4-11.	Products of Ozonation of Various Compounds .	4-38
4-12.	Waste Treatment Applications for Selected Oxidants	4-40
4-13.	Properties of Some Commercially Available Resin Absorbents	4-45
4-14.	Conventional Chrome Reduction Reactions . .	4-49
4-15.	Chemical Treatment of Industrial Waste Water by Coagulation	4-56
4-16.	Commercial Applications of Ultrafiltration .	4-72
4-17.	Development Applications of Ultrafiltration	4-73
4-18.	Natural Sorbents and Their Capacity for Removal of Specific Contaminants from Liquid Phases of Natural, Basic, and Acidic Wastes	4-90
4-19.	Approximate Reagent Requirements for Various Waste Types Using a Portland Cement/Fly Ash Solidification	4-91
4-20.	Key Features of Major Types of Incinerators	4-94
4-21.	Design Criteria for Fluidized Bed Furnace .	4-97
4-22.	Design Criteria for Multiple Hearth Furnace	4-98
4-23.	Examples of One-Hour Oxidation of Selected Compounds	4-102
4-24.	Temperature/Pressure Relationship of Saturated Steam	4-103

CHAPTER 1

INTRODUCTION

1-1. Purpose. This manual provides design guidelines that will aid U.S. Army Corps of Engineers Districts and Divisions in the selection of remedial actions at uncontrolled hazardous waste sites. These guidelines are to be used in support of the Department of Defense Environmental Restoration Program (DERP), the Formerly Used Defense Sites (FUDS) Program, Resources Conservation and Recovery Act (RCRA), support to U.S. Environmental Protection Agency (EPA) activities associated with the Comprehensive Environmental Response, Compensation, and Liability Act (CERCLA), and the remediation of hazardous waste contamination at Civil Works sites.

1-2. Applicability. This manual applies to those major subordinate commands and USACE districts assigned missions in support of the Nation*s efforts to remediate uncontrolled hazardous waste releases.

1-3. References. Required and related references cited in this manual are listed in Appendix A.

1-4. Explanation of Abbreviations and Terms. Abbreviations and terms used in this manual are explained in the Glossary (Appendix C).

1-5. USACE Responsibilities.

a. In response to the negative impacts of improper waste disposal, Congress passed PL 94-580, the Resource Conservation and Recovery Act (RCRA), and PL 96-510, the Comprehensive Environmental Response, Compensation, and Liability Act (CERCLA) of 1980 (commonly referred to as "Superfund"). CERCLA was subsequently amended by the Superfund Amendments and Reauthorization Act (SARA) of 1986.

b. Although the EPA has overall statutory responsibility for implementation of CERCLA, the USACE has a significant technical role in ensuring the implementation of remedial actions at DoD (and former DoD) sites where the uncontrolled release of hazardous substances has occurred. Remedial actions can consist of, but may not be limited to, field investigations to define the problem and determine its extent; feasibility studies to develop options for remedial action; selection of one or more cost-effective remedial actions; and final design and implementation (construction and provision for future monitoring).

c. The USAGE has multiple missions in the Nation*s efforts to remediate environmental problems resulting from past improper waste disposal practices.

(1) EPA*s program for implementation of Superfund provides for emergency action and for remedial action at disposal sites. The USACE*s responsibility under the IAG is primarily associated with the remedial action portion of the program. The USACE will be responsible for the management of design, construction, and installation of monitoring systems for those sites that are selected by EPA and assigned to the USACE. The USACE may also assist

EPA in review of state-managed projects for biddability and constructibility, or in design or construction execution oversight as EPA*s agent. The USACE assists the EPA during the field investigation and feasibility study phases. This assistance is essential to familiarize USACE personnel with the EPA-selected remedial action, and to assure the USAGE that the EPA-selected remedy is reasonable to design, construct, operate, and maintain.

(2) The USACE*s responsibilities under DERP (IRP and FUDS) are significantly broader than those associated with the support to EPA through the Superfund IAG. The USAGE may have full responsibility for: managing and/or conducting field investigations to define the problem and determine its extent; feasibility studies to develop options for remedial action; selection of a cost-effective remedial action; final design of the selected remedial action; and implementation of the selected remedial action. Implementation may include construction, operation and maintenance, and provisions for future monitoring.

(3) The USACE may provide support on RCRA facilities that must comply with RCRA Facility Investigation/Corrective Measures Study/Corrective Measure Implementation (RFI/CMS/CMI) criteria. RFI/CMS/CSI criteria, although technically similar to criteria for implementing remedial actions under CERCLA, must be performed in accordance with EPA 530/SW-88-028, OSWER Directive 9902.3. In addition, support provided under CERCLA may be required to comply with RCRA substantive requirements.

(4) The USAGE must address contamination attendant with Civil Works sites. These activities are described in detail in ER 1165-2-132.

d. Remedial action at a waste disposal site may take the form of onsite control, offsite disposal, onsite treatment, onsite storage, or combinations of these. For example, remedial action may consist of surface flow controls that divert and channel rainfall, thus preventing infiltration of water into the waste site. Or remedial action may deal specifically with controlling the spread of contaminated ground water, either by containment or pumping and treating. Other types of remedial action involve controlling the migration of dangerous gases and vapors from the site, removing the waste material from the site for treating and disposal, and cleaning up water mains, sewers, wetlands, soils, and water bodies that have been contaminated.

e. Many of the construction and design techniques associated with the USAGE*s portion of the program are familiar to USAGE personnel, but some are not and these will usually be associated with those sites where the greatest degree of hazard exists. For example, a principal difference in the construction aspect is the high degree of control necessary for proper management of USAGE and contractor activities.

f. In addition to providing support in programs to remediate the Nation*s hazardous and toxic radioactive waste (HTRW) problems, USAGE has responsibility for consideration of HTRW impacts in conjunction with its own Civil Works mission. Some of the activities described in this manual are applicable to HTRW investigations in the development and operation of Civil Works projects of the Corps. The same technical investigations and analysis

are required as for the Superfund, DERP, and RCRA efforts, but there are different administrative and reporting requirements. The reconnaissance phase of the development process for a Civil Works project requires an analysis of the potential for discovery of HTRW in the project area. Such analysis is to be based on available data and a field survey without sampling and testing. If there is potential for HTRW, a determination of the nature and extent of contamination as well as a preliminary analysis of remediation actions is required during the feasibility phase of Civil Works project development. In cases where the Corps is responsible for remediation of HTRW in conjunction with a Civil Works project, a detailed design and construction plan for the remediation would be required. ER 1165-2-132 provides guidance on consideration of HTRW in conjunction with Civil Works projects.

1-6. Safety. Health and safety are overriding concerns during all construction activities. These concerns are compounded on remedial action projects. However, a detailed discussion of construction safety is beyond the scope of this manual. The user of this manual should consult ER 385-1-92, Safety and Occupational Health Document Requirements for Hazardous, Toxic and Radioactive Waste Activities, EM 385-1-1, Safety and Health Requirements Manual, and local safety or occupational health officers for additional information on health and safety requirements associated with remedial activities.

CHAPTER 2

IDENTIFICATION AND SELECTION OF REMEDIAL ACTION/CORRECTIVE MEASURE ALTERNATIVES

Section I. Introduction

2-1. Three-Step Approach.

a. Responses to the uncontrolled release of hazardous substances are conducted under the statutory authority of either CERCLA or RCRA. Although the terminology used under each authority is different, in each case the identification and selection of the appropriate response to the release of hazardous substances is conducted in an orderly, phased approach. Figure 2-1 illustrates the similarities and differences between the response action process under each statute. Because of the similarities in the processes and the substantially larger experience base associated with response actions conducted under CERCLA, the remainder of this chapter focuses on the CERCLA process and uses CERCLA terminology. Where appropriate, the user of this manual should use Figure 2-1 and Table 2-1 to crosswalk between the CERCLA and RCRA response action processes.

b. Under CERCLA, the identification and selection of the appropriate response to the uncontrolled release of hazardous substances is conducted in an orderly, phased approach consisting of three steps: (1) the preliminary assessment (PA), (2) the site investigation (SI), and (3) the remedial investigation/feasibility study (RI/FS). The overall process is shown in Figure 2-2.

c. The PA is usually a review of historical records, including current and past land uses. The emphasis of the PA is the identification of activities that may have resulted in the improper handling of hazardous substances. Interviews with personnel familiar with site operations may be conducted during the PA. The PA is designed to identify the potential, not the extent, of a hazardous waste problem.

d. Should the PA reveal a potential problem, a SI may be conducted. The SI includes topographic setting, geological surveys, surface and groundwater flow, building and utility layouts, and the condition of structures located on site. The SI may include some field investigations to identify site characteristics such as soil contamination, liquid discharges, and abnormalities in vegetation.

e. Should the SI indicate the need for further study, a RI/FS may be conducted. The RI/FS is the methodology that the USEPA Superfund program has established for characterizing the nature and extent of risks posed by uncontrolled hazardous waste sites and for evaluating potential remedial options. This approach should be tailored to specific circumstances of individual sites; it is not a rigid step-by-step approach that must be conducted identically at every site. The objective of the RI/FS is not the unobtainable goal of removing all uncertainty, but rather to gather information sufficient to support an informed risk management decision

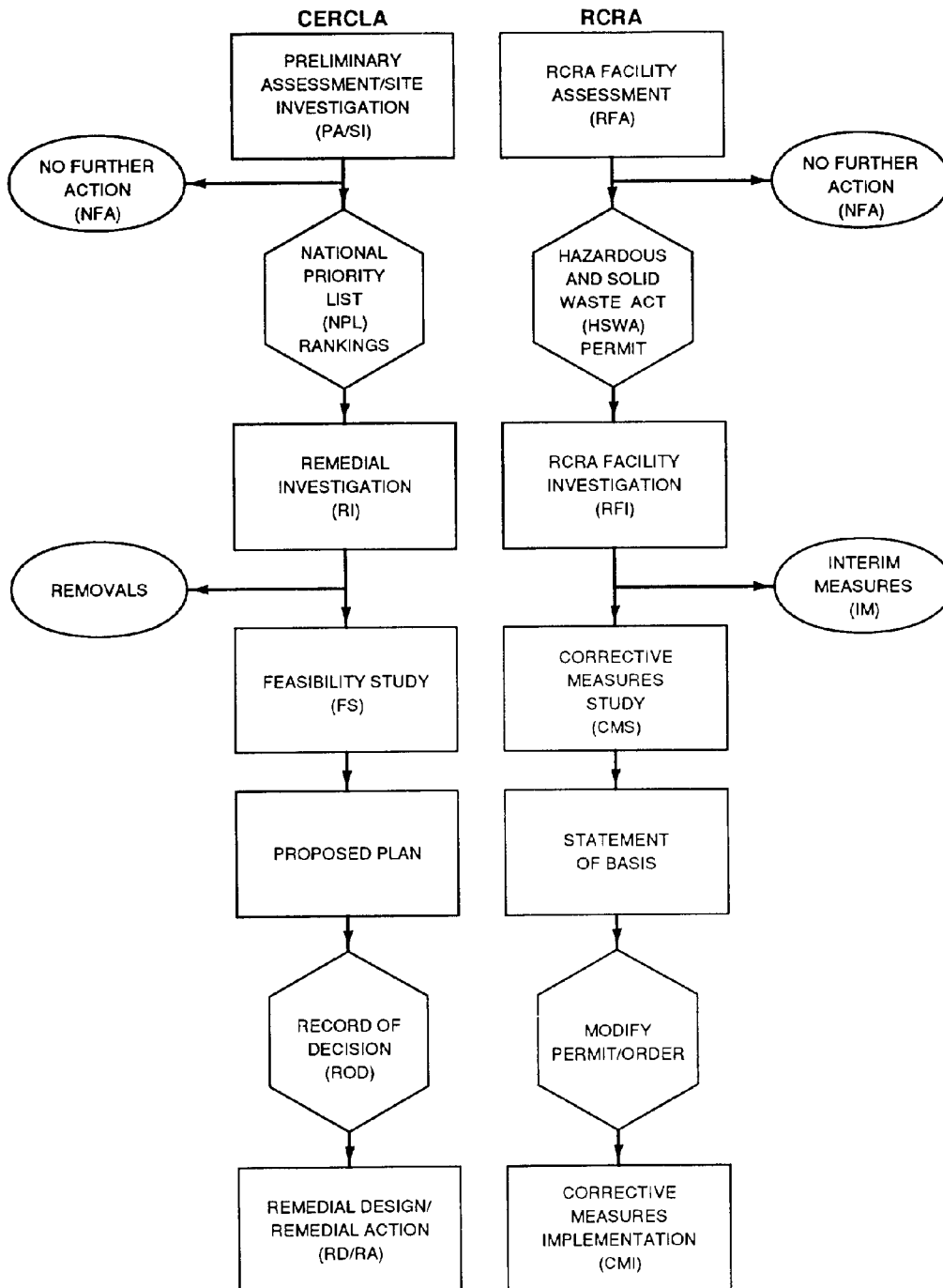

Figure 2-1. Comparison of RCRA/CERCLA Action Processes

Table 2-1. CERCLA\RCRA Terminology Crosswalk

CERCLA Process	RCRA Process	Objective
Preliminary Assessment (PA)	RCRA Facility Assessment (RFA)	Determine the potential for a present or past release, based primarily on historical records.
Site Investigation (SI)	See Note 1	Provide sufficient information to determine the need for a full remedial investigation, based on preliminary site data and field sampling for contamination.
Remedial Investigation (RI)	RCRA Facility Investigation (RFI)	Characterize the nature, extent, direction, rate, movement and concentration of releases.
Feasibility Study (FS)	Corrective Measures Study (CMS)	Evaluate potential remedial actions and provide sufficient information to decision makers to allow an informed decision.

¹ There is no direct RCRA equivalent for the SI. The RFA may have many of the field investigation aspects of the SI.

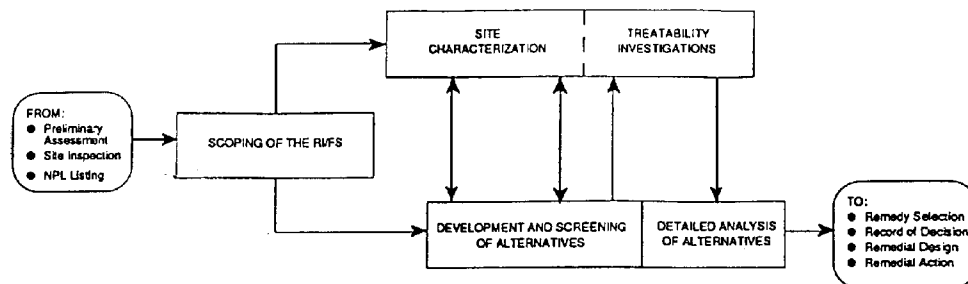

Figure 2-2. Remedial Action Evaluation Process

regarding which remedy appears to be most appropriate for a given site. The general RI/FS process is shown in Figure 2-3.

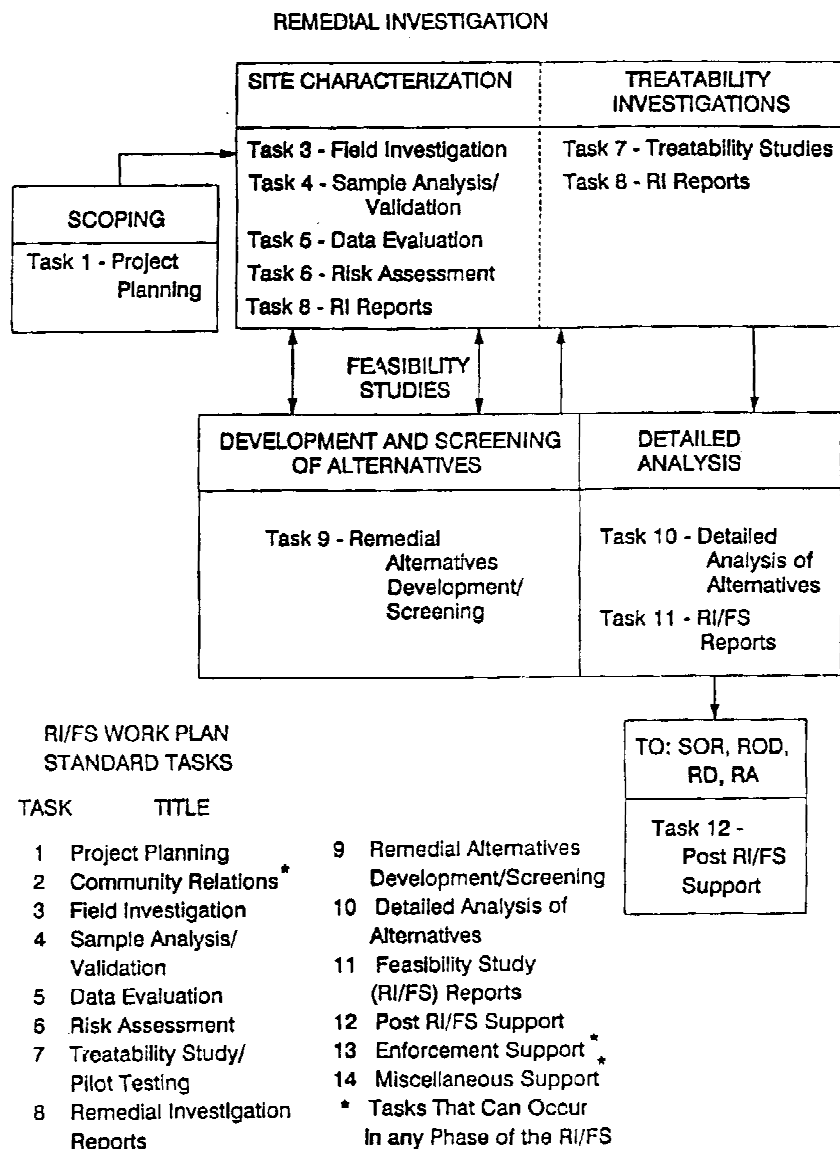

Figure 2-3. Overview of the RI/FS Process

2-2. Guidance.

a. For primary guidance on the formulation, evaluation, and selection of remedial action alternatives, the National Oil and Hazardous Substances Contingency Plan (NCP) found at 40 CFR 300 should be followed.

b. For detailed information on the conduct of remedial investigations and feasibility studies, EPA's Guidance on Conducting Remedial Investigations and Feasibility Studies Under CERCLA (Interim Final, October 1988) should be consulted. The revised guidance is designed to (1) reflect new emphasis and provisions of the Superfund Amendments and Reauthorization Act (SARA), (2) incorporate aspects of new or revised guidance related to aspects of remedial investigations and feasibility studies (RI/FSs), (3) incorporate management initiatives designed to streamline the RI/FS process, and (4) reflect experience gained from previous RI/FS projects.

2-3. RI/FS Procedure.

a. Scoping. Scoping is the initial planning phase of the RI/FS process, and many of the planning steps begun here are continued and refined in later phases of the RI/FS. Scoping activities typically begin with the collection of existing site data, including data from previous investigations such as the preliminary assessment and site investigation. On the basis of this information, site management planning is undertaken to preliminarily identify boundaries of the study area, identify likely remedial action objectives and whether interim actions may be necessary, and establish whether the site may best be remedied as one unit or several separate operable units. Once an overall management strategy is agreed upon, the RI/FS for a specific project or the site as a whole is planned. Typical scoping activities, shown in Figure 2-4, include:

(1) Initiating the identification of potential applicable or relevant and appropriate requirements (ARARs) and discussing them with the support agency.

(2) Determining the types of decisions to be made and identifying the data and other information needed to support those decisions.

(3) Assembling a technical advisory committee to serve as a review board for important deliverables and to monitor progress during the study.

(4) Preparing the work plan, the sampling and analysis plan (SAP) (which consists of the quality assurance project plan (QAPP) and the field sampling plan (FSP)), the health and safety plan, and the community relations plan.

b. Site Characterization.

(1) During site characterization, field sampling and laboratory analyses are initiated. Field sampling should be phased so that the results of the initial sampling efforts can be used to refine plans developed during scoping to better focus subsequent sampling efforts. Data quality objectives

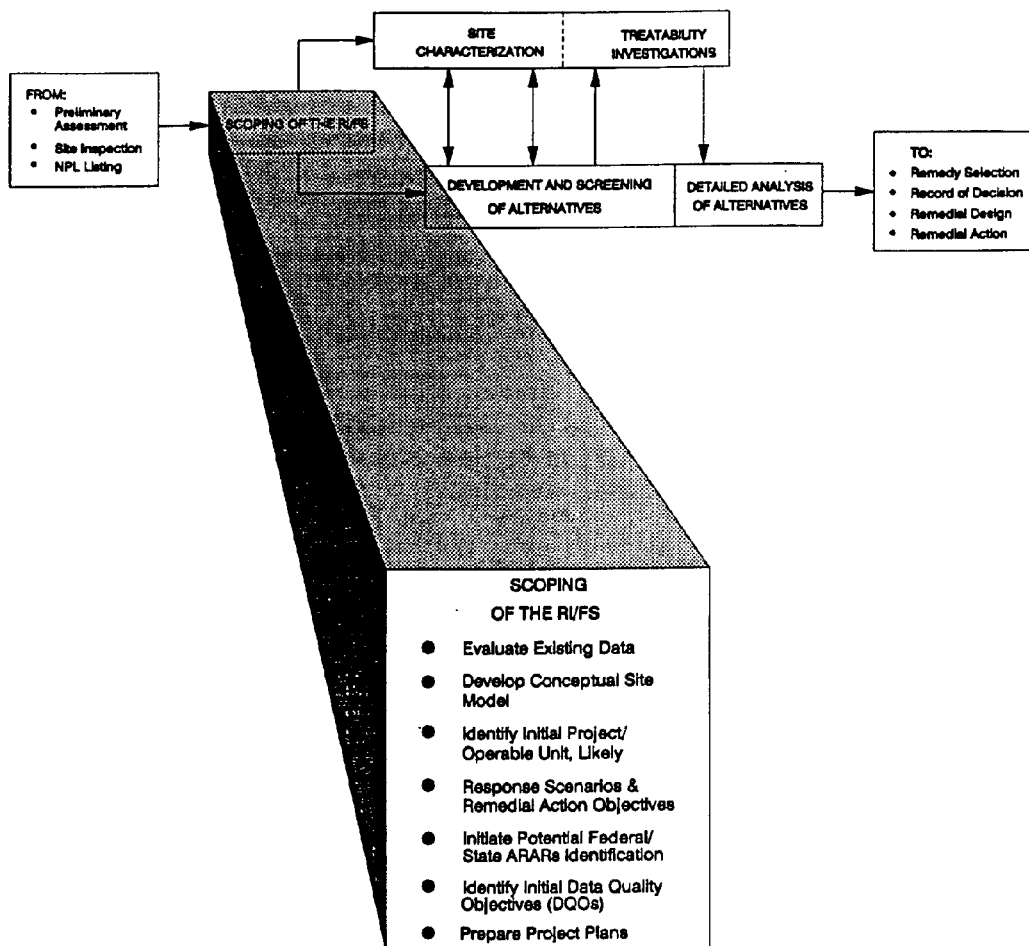

Figure 2-4. Scoping the RI/FS Process

are revised based on an improved understanding of the site to facilitate a more efficient and accurate characterization of the site and, therefore, achieve reductions in time and cost.

(2) A preliminary site characterization summary is prepared to provide the lead agency with information on the site early in the process before preparation of the full RI report. This summary will be useful in determining the feasibility of potential technologies and in assisting both the lead and support agencies with the initial identification of ARARs. It can also be used to assist in performing their health assessment of the site.

(3) A baseline risk assessment is developed to identify the existing or potential risks that may be posed to human health and the environment by the site. This assessment also serves to support the evaluation of the no-action alternative by documenting the threats posed by the site based on

expected exposure scenarios. Because this assessment identifies the primary health and environmental threats at the site, it also provides valuable input to the development and evaluation of alternatives during the FS. Site characterization activities are shown in Figure 2-5.

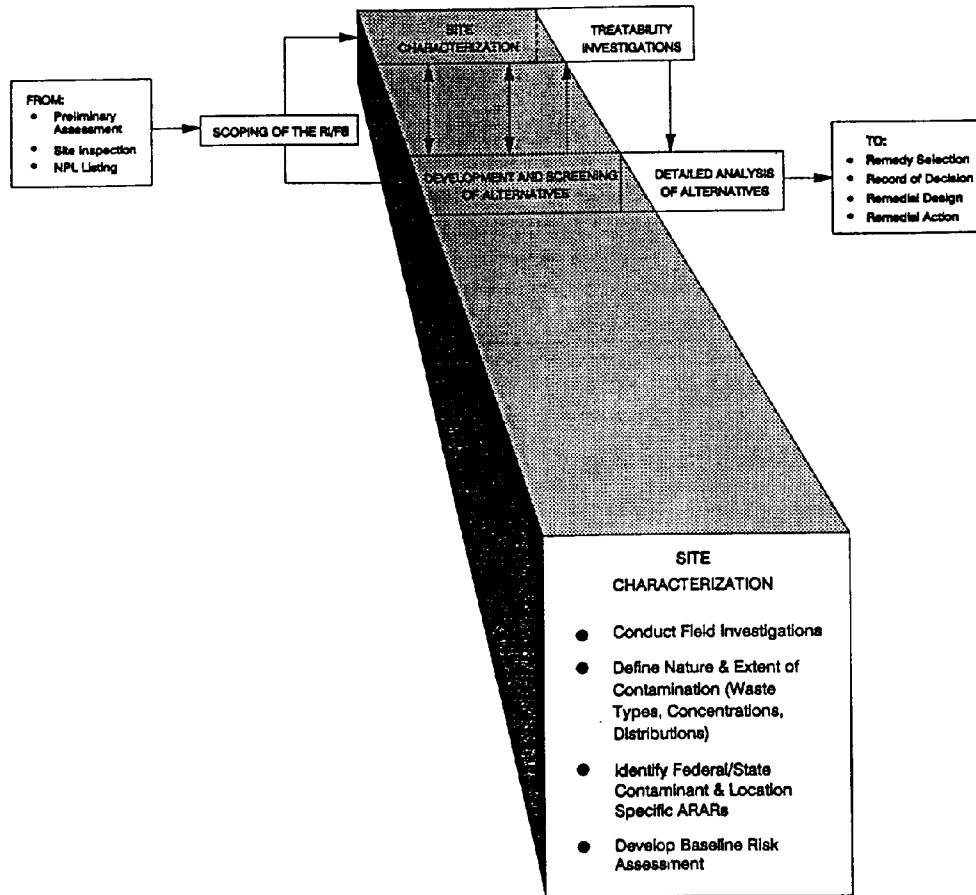

Figure 2-5. Overview of the Site Characterization Process

c. Development and Screening of Alternatives.

(1) The development of alternatives usually begins during or soon after scoping, when likely response scenarios may first be identified. The process for developing and screening of alternatives is shown in Figure 2-6. The development of alternatives requires (a) identifying remedial action objectives; (b) identifying potential treatment, resource recovery, and

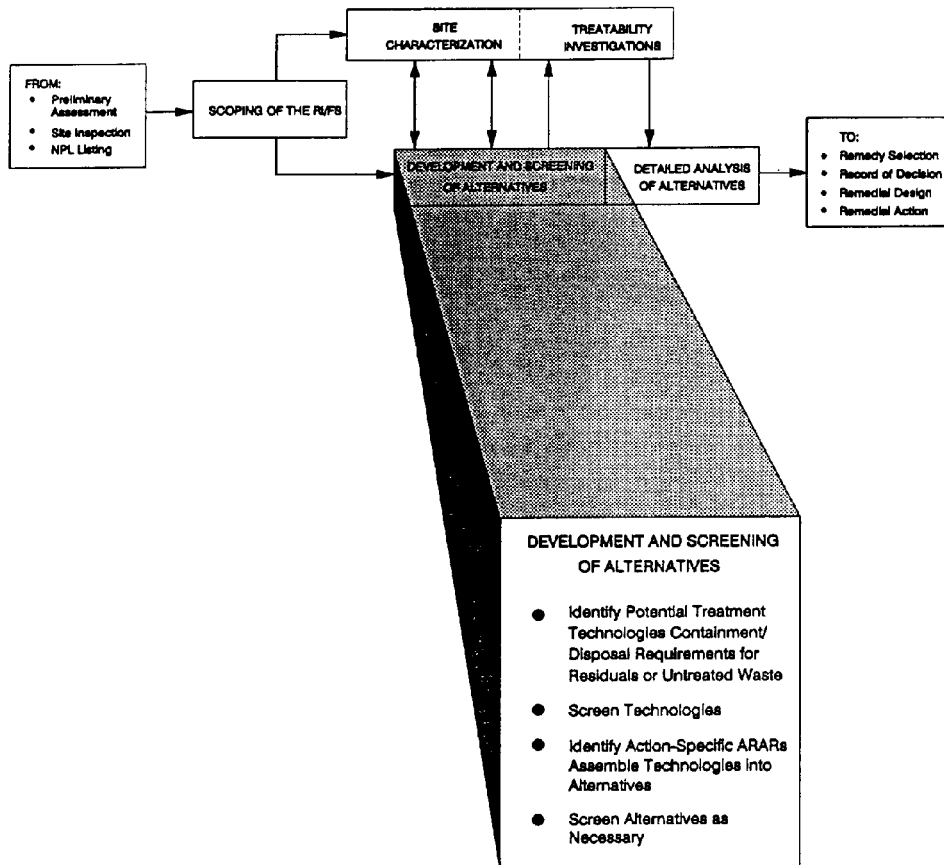

Figure 2-6. Overview of the Development and Screening of Alternatives Process

containment technologies that will satisfy these objectives; (c) screening the technologies based on their effectiveness, implementability, and cost; and (d) assembling technologies and their associated containment or disposal requirements into alternatives for the contaminated media at the site or for the operable unit. Alternatives can be developed to address contaminated medium (e.g., ground water), a specific area of the site (e.g., a waste lagoon or contaminated hot spots), or the entire site. Alternatives for specific media and site areas either can be carried through the FS process separately or combined into comprehensive alternatives for the entire site. The approach is flexible to allow alternatives to be combined at various points in the process.

(2) A range of treatment alternatives should be developed, varying primarily in the extent to which they rely on long-term management of residuals and untreated wastes. The upper bound of the range would be an alternative that would eliminate, to the extent feasible, the need for any long-term management (including monitoring) at the site. The lower bound would consist of an alternative that involves treatment as a principal element (i.e., treatment is used to address the principal threats at the site), but some long-term management of portions of the site that did not constitute "principal threats" would be required. Between the upper and lower bounds of the treatment range, alternatives varying in the type and degrees of treatment and associated containment/disposal requirements should be included. In addition, one or more containment options involving little or no treatment should be developed, and a no-action alternative should always be developed.

(3) Once potential alternatives have been developed, it may be necessary to screen out certain options to reduce the number of alternatives that will be analyzed in detail in order to minimize the resources dedicated to evaluating options that are less promising. The necessity of this screening effort will depend on the number of alternatives initially developed, which will depend partially on the complexity of the site and/or the number of available, suitable technologies. For situations in which it is necessary to reduce the initial number of alternatives before beginning the detailed analysis, a range of alternatives should be preserved so that the decisionmaker can be presented with a variety of distinct, viable options from which to choose. The screening process involves evaluating alternatives with respect to their effectiveness, implementability, and cost. It is usually done on a general basis and with limited effort (relative to the detailed analysis) because the information necessary to fully evaluate the alternatives may not be complete at this point in the process.

d. Treatability Investigations. Should existing site and/or treatment data be insufficient to adequately evaluate alternatives, treatability tests may be necessary to evaluate a particular technology on specific site wastes. Generally, treatability tests involve bench-scale testing to gather information to assess the feasibility of a technology. In a few situations, a pilot-scale study may be necessary to furnish performance data and develop better cost estimates so that a detailed analysis can be performed and a remedial action can be selected. To conduct a pilot-scale test and keep the RI/FS on schedule, it will usually be necessary to identify and initiate the test early in the process.

e. Detailed Analysis. Once sufficient data are available, alternatives are evaluated in detail with respect to nine evaluation criteria that the EPA has developed to address the statutory requirements and preferences of CERCLA. The alternatives are analyzed individually against each criterion and then compared to determine their respective strengths and weaknesses and to identify the key tradeoffs that must be balanced for that site. The results of the detailed analysis are summarized and presented to the decisionmaker so that an appropriate remedy consistent with CERCLA can be selected. The detailed analysis process is shown in Figure 2-7.

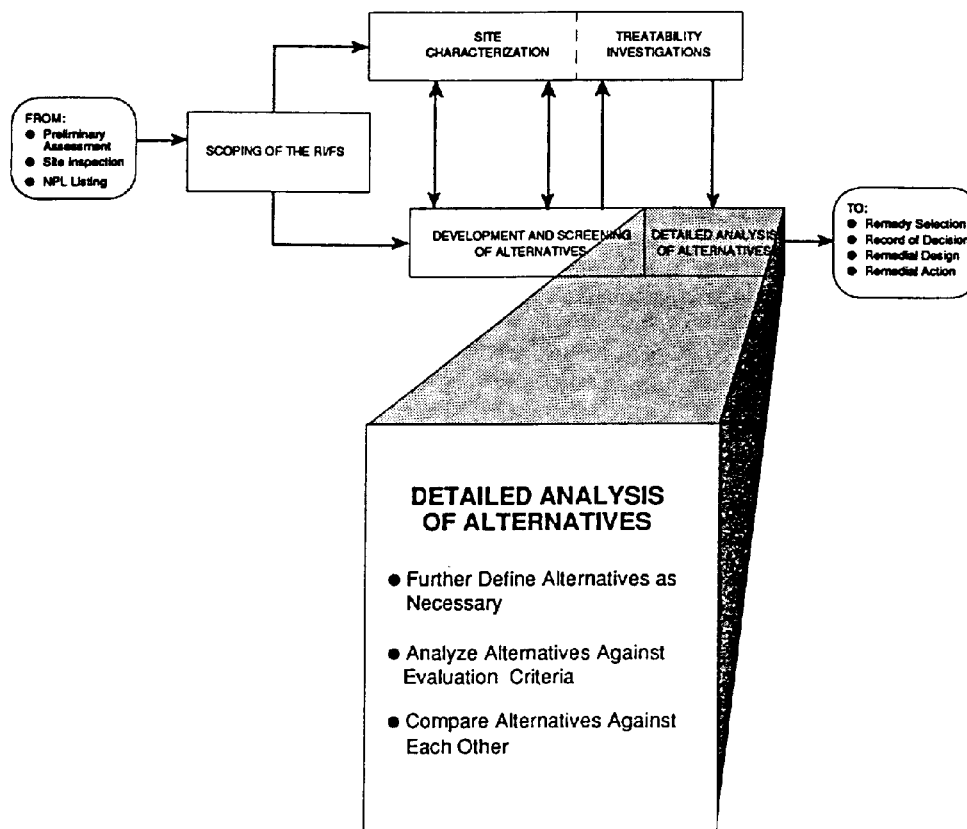

Figure 2-7. Overview of the Detailed Analysis of Alternatives Process

Section II. Determining the Nature and Extent of Contamination

2-4. Existing Site Conditions. The first step in the remediation process is to determine the nature and extent of contamination. The scope and complexity of the investigation and any subsequent studies are highly site specific.

2-5. Scoping. Scoping is the initial planning phase of site remediation and is begun, at least informally, by the lead agency*s responsible project manager as part of the funding allocation and planning process. The lead and support agencies should meet and, on the basis of available information, begin to identify (a) the types of actions that may be required to address site problems; (b) whether interim actions are necessary to mitigate potential threats, prevent further environmental degradation, or rapidly reduce risks

significantly, and (c) the optimal sequence of site actions and investigative activities.

a. Objectives. Once the lead and support agencies initially agree on a general approach for managing the site, the next step is to scope the project and develop specific project plans. Project planning is done to:

- (1) Determine the types of decisions to be made.
- (2) Identify the type and quality of data quality objectives (DQOs) needed to support those decisions.
- (3) Describe the methods by which the required data will be obtained and analyzed.
- (4) Prepare project plans to document methods and procedures.

b. Project Planning. The specific activities conducted during project planning include:

- (1) Meeting with lead agency, support agency, and contractor personnel to discuss site issues and assign responsibilities for RI/FS activities.
- (2) Collecting and analyzing existing data to develop a conceptual site model that can be used to assess both the nature and the extent of contamination and to identify potential exposure pathways and potential human health and/or environmental receptors.
- (3) Initiating limited field investigations if available data are inadequate to develop a conceptual site model and adequately scope the project.
- (4) Identifying preliminary remedial action objectives and likely response actions for the specific project.
- (5) Preliminarily identifying the ARARs expected to apply to site characterization and site remediation activities.
- (6) Determining data needs and the level of analytical and sampling certainty required for additional data if currently available data are inadequate to conduct the FS.
- (7) Identifying the need and the schedule for treatability studies to better evaluate potential remedial alternatives.
- (8) Designing a data collection program to describe the selection of the sampling approaches and analytical options. (This selection is documented in the SAP, which consists of the FSP and QAPP elements.)
- (9) Developing a work plan that documents the scoping process and presents anticipated future tasks.

(10) Identifying and documenting health and safety protocols required during field investigations and preparing a site health and safety plan.

(11) Conducting community interviews to obtain information that can be used to develop a site-specific community relations plan that documents the objectives and approaches of the community relations program.

(12) Submitting deliverables required for all RI/FSs in which field investigations are planned including a work plan, SAP, a health and safety plan (HSP), and a community relations plan (CRP). Although these plans usually are submitted together, each plan may be delivered separately.

2-6. Site Characterization.

a. Remedial action at any uncontrolled hazardous waste disposal site is preceded by an extensive site investigation. In most cases, the site investigation is conducted in sequenced phases. The initial site description is usually completed by the state or Federal agency that is screening the site to identify the associated hazards and to determine its ranking as a prospective candidate for cleanup activities. In this screening operation, information often is collected that is not directly applicable to engineering problems, and critical factors may be omitted that are necessary for selection of specific remedial measures. At various stages in the design of remedial measures, it becomes necessary to develop specific information for evaluation of particular processes; i.e., additional phases of data collection become necessary as the remedial program evolves.

b. During site characterization, the SAP, developed during project planning, is implemented and field data are collected and analyzed to determine to what extent a site poses a threat to human health or the environment. The major components of site characterization are presented in Figure 2-5 and include:

- (1) Conducting field investigations.
- (2) Analyzing field samples in the laboratory.
- (3) Evaluating results of data analyses to characterize the site and develop a baseline risk assessment.
- (4) Determining if data are sufficient for developing and evaluating potential remedial alternatives.

c. Because information on a site can be limited prior to conducting an RI, it may be desirable to conduct two or more iterative field investigations so that sampling efforts can be better focused. Therefore, rescoping may occur at several points in the RI/FS process. During site characterization, rescoping and additional sampling may occur if the results of field screening or laboratory analyses show that site conditions are significantly different than originally believed. In addition, once the analytical results of samples have been received (either from a laboratory or a mobile lab) and the data evaluated, it must be decided whether further sampling is needed to assess

site risks and support the evaluation of potential remedial alternatives in the FS. At this time, it is usually apparent whether the data needs identified during project planning were adequate and whether those needs were satisfied by the first round of field sampling.

d. Field investigation methods used in RIs are selected to meet the data needs established in the scoping process and outlined in the work plan and SAP. Specific information on the field investigation methods described below is contained in A Compendium of Superfund Field Operations Methods (EPA 1987)

e. The initial investigation for site screening purposes produces a body of data that, in most cases, provides the basis for planning all further data collection. At the beginning of any remedial program, it is vital that the screening data be examined critically and data gaps be identified. Any remedial investigation report generated by a site inspection team will include a description of the physical layout of the site and the activity at the site; i.e. , treatment, storage, concentration, reclaiming of waste, etc., and a preliminary assessment of the nature and extent of the hazard posed by the site, e.g. , toxic release, fire, explosion, etc.

f. Table 2-2 provides a checklist of the major features to be included in any site description. In many cases, limitations of time and equipment may prevent the site visitation team from making complete assessments, and some features of the site that are critical to remedial action may be intentionally or unintentionally concealed by the personnel at the site. For example, where drummed wastes have been stored in an unprotected manner, it would not be surprising to discover that drums are also buried at the site. In some cases, the visible wastes may be less of a problem than the buried material. If bulk liquids were handled and the site investigation indicated the absence or inadequacy of controlled drainage loading and unloading areas, it may be assumed that spillage has contaminated the soils at waste transfer points. Inferences such as this are helpful in providing clues as to what additional investigations would be useful. Table 2-3 provides guidance on what features in the initial remedial concept report can be useful in indicating the course for further data collection.

g. In any review of preliminary hazard assessments and site inspection reports, all major pathways for movement of toxicants should be considered (Figure 2-8). The review should result in a ranking of potential or actual waste dispersal pathways as to potential damage to the site*s surroundings and an overall hazard assessment based on waste characteristics, pathways, receptors, and site management practices (Figure 2-9).

2-7. Health and Safety Considerations.

a. Due to the very nature of remedial investigation, necessary precautions to prevent loss of life, prevent injury, or minimize health hazards are paramount. Since exact rules cannot be developed for every contingency, an effective health and safety program should take into consideration:

Table 2-2. Checklist of Major Features Included in
Site Description

I. Site Sketch

The following features should be included:

Site boundaries	Loading/unloading areas
Entrance and exit locations	Office areas
Access roads	Water well locations
Disposal locations	Treatment facility locations
Storage areas	Surface drainage

II. Chemical Storage Facilities Description

Storage tanks: number, volume, condition, content, etc.

Drums: number, condition, labeling, volume, content, etc.

Lagoons and surface pits: number, size, use of liner, content, etc.

III. Treatment Systems

The presence of any treatment systems should be noted. These can be difficult to evaluate visually. General appearance, maintenance, and integrity should be visually assessed; operators should be asked for any monitoring records; presence of odors should be noted; any effluents or residues should be visually characterized; and types of wastes and volumes treated should be described.

Incinerators	Volume reduction
Flocculation/filtration	Waste recycling
Chemical/physical treatment	Other
Biological treatment	

IV. Disposal Facilities

The presence and use of any of the following operations should be noted. A description of the size, use of liners, soil type, presence of leachate, and presence of dead vegetation or animals should be obtained. A description of management practices should be obtained. Site workers should be interviewed. Waste types should be described.

Landfills	Surface impoundment
Landforms	Underground injection
Open dump	Incineration

(Continued)

Table 2-2 (Concluded)

V. Hazardous Substance Characteristics

Manifests, inventories, or monitoring reports should be obtained. Markings on containers should be noted.

Chemical identities	Container markings
Quantities	Monitoring data, other
Hazard characteristics (toxic, explosive, flammable, etc.)	analytical data Physical state (liquid, solid, gas, sludge)

VI. Geohydrological Assessment

Situations that promote hazardous substance migration (i.e. , porous soils, porous or fractured bedrock formations, shallow water tables, flowing streams or rivers nearby, etc.) should be included in the site report.

Soil geology or rock type	Water wells (use and water depth)
Surface water features	Erosion potential
Surface drainage pattern	Flooding potential
Ground-water conditions/depths/ movement	

VII. Identification of Sensitive Receptors

Number and location of private homes	Other public use areas (roads, parks, etc.)
Public buildings	Natural areas

- (1) Established rules and adherence thereto.
- (2) The application of common sense, judgment, and technical analysis.

b. ER 385-1-92 comprehensively establishes those safety and health documents and procedures required to be developed for hazardous and toxic waste (HTW) activities. 29 CFR 1910.120 addresses the safety and health of employees working at hazardous waste sites. It defines, at least in a regulatory sense, the components of an effective safety and health program, and should be considered the primary reference for all safety and health-related matters at hazardous waste operations.

c. Agencies involved in remedial investigations must clearly establish an effective organization with prescribed responsibilities. Detailed discussions of the various levels of responsibility of an organization are covered in applicable EPA guidance.

Table 2-3. Critical Areas in Evaluation of Site
Data from Preliminary Assessment

I. Waste Volumes

Do the input, output, and storage records agree with observed activities? Were wastes received and not logged in? Are designated wastes received and not logged in? Are designated waste burial sites of a size consistent with the volumes recorded? If drum storage is used, are the drums filled and do they contain solids or liquids? Would an inventory based on a drum count be reliable for this site?

II. Waste Characteristics

Do analyses of samples of wastes agree with recorded contents on logs and labels? Is there obvious evidence from drum corrosion or fuming that the labels are incorrect? Are wastes observed consistent with the stated waste sources?

III. Extent of Damage Observed

Do ground-water, surface-water, and soil samples show contaminants consistent with the types of wastes appearing on records, logs, manifests, and labels? Are the wells sampled for water contamination suitable as monitoring wells in construction and location?

2-8. Data Base Requirements. A data base for each site will be developed as the site investigation proceeds. As the selection of remedial action is made, additional specific data requirements will appear. Typically, the preliminary site assessment will produce a compilation of data on types of material, receptors, and site management practices. As specific options are investigated and treatment or containment options are evaluated, more data on the type of material and on the position and concentration of specific pollutants in ground or surface water will be required.

a. Waste Identification and Quantification.

(1) In most field investigations for site assessment an attempt will be made to select samples from an enforcement viewpoint, i.e., to find high concentrations of toxicants that must be cleaned up. Samples collected in nonenforcement activities (normal site characterization) may have been taken using a random sampling technique to obtain average concentrations of potential toxicants. Care should be taken to distinguish between these two types of samples in evaluating site assessment data.

(2) Table 2-4 gives the typical numbers of samples taken for analysis from different types of waste containers or waste spill areas. Full use of these data should be made in planning additional sample collection and analysis activities. In data collected for detailed design of remedial actions,

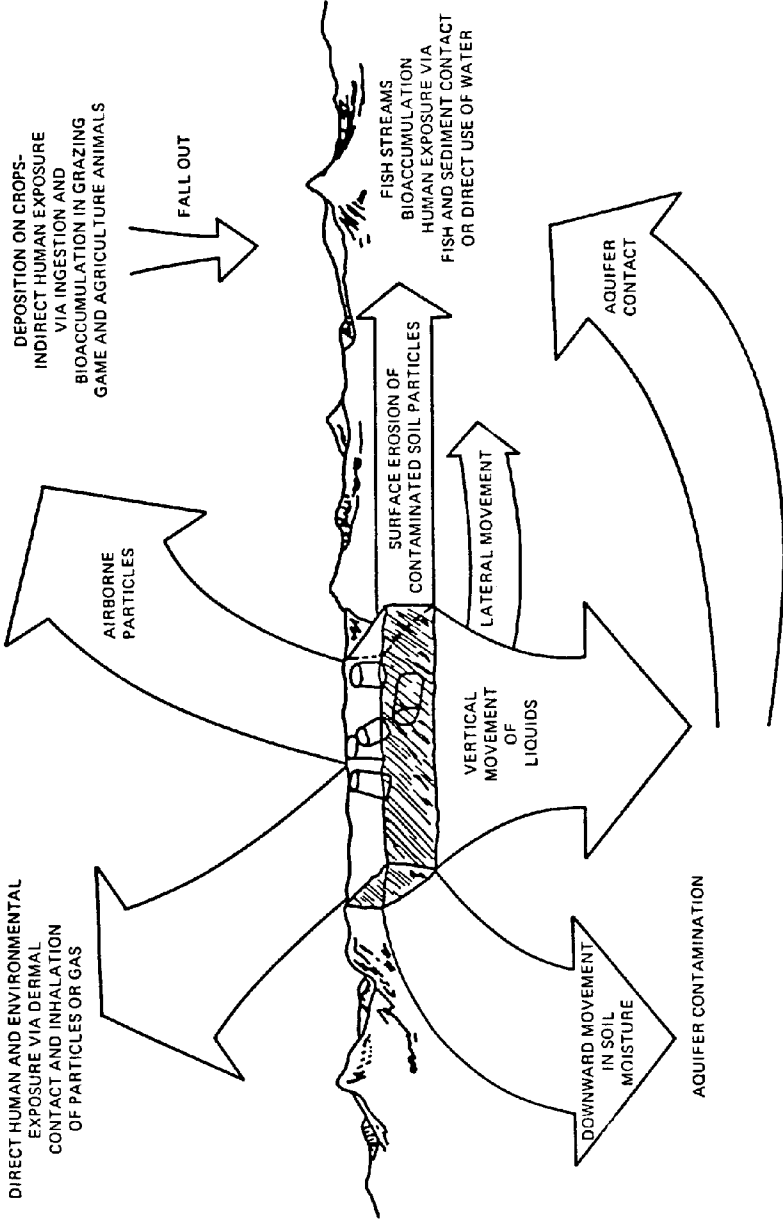

Figure 2-8. Dispersal Pathways for Contaminants

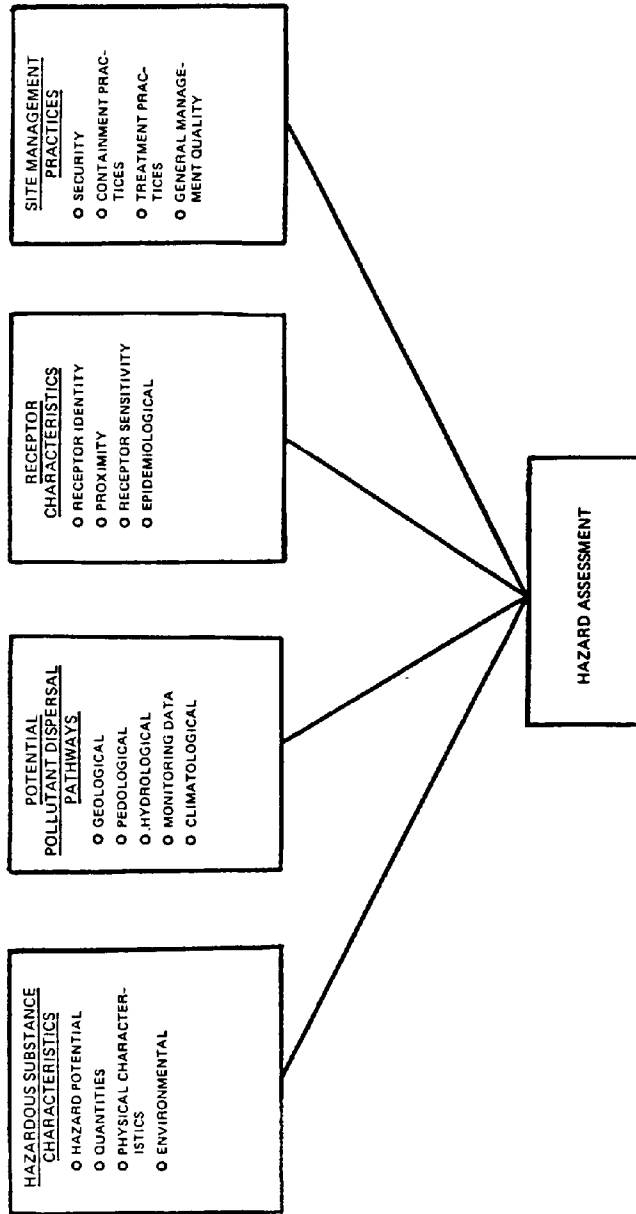

Figure 2-9. Topic Areas for the Hazardous Substance Site Assessment

Table 2-4. Typical Number of Samples to be Collected
for Different Informational Requirements

<u>Case No.</u>	<u>Information desired</u>	<u>Waste type</u>	<u>Container type</u>	<u>Number of samples to be collected</u>
1	Average concentration	Liquid	Drum, vacuum truck, and similar containers	1
2	Average concentration	Liquid	Pond, pit, lagoon	1 combined sample of several samples collected at different points or levels
3	Average concentration	Solid (powder or granular)	Bag, drum, bin, sack	Same as case No. 2
4	Average concentration	Waste pile	- -	Same as case No. 2
5	Average concentration	Soil	- -	1 combined sample of several samples collected at different sampling areas
6	Concentration range	Liquid	Drum, vacuum truck, storage tank	3 to 10 samples, each from a different depth of the liquid
7	Concentration range	Liquid	Ponds, pit, lagoon	3 to 20 samples from different sampling points and depths
8	Concentration range	Solid (powder or granular)	Bag, drum, bin	3 to 5 samples from different sampling points
9	Concentration range	Waste pile	- -	Same as case No. 8
10	Concentration range	Soil	- -	3 to 20 samples from different sampling areas

(Continued)

Table 2-4. (Concluded)

<u>Case No.</u>	<u>Information desired</u>	<u>Waste type</u>	<u>Container type</u>	<u>Number of samples to be collected</u>
11	Average concentration for legal evidence	All types	All containers	3 identical samples or 1 combined sample divided into 3 identical samples if homogeneous
12	Average concentration	Liquid	Storage tank	Same as case No. 6

ranges of concentration of contaminants will be the critical criterion for design rather than the highest value obtained or the average value.

(3) Waste quantification is performed in an approximate manner during preliminary site assessment through drum counts (often made from aerial photos) or volume estimates of lagoons, along with written records of waste burial. However, many of the approximate numbers may have to be refined for scaling treatment or containment strategies. For example, additional soil samples may be required if a major soil cleanup is contemplated. Drummed liquid wastes may have to be examined to determine if they still contain the waste originally placed in them. The life of a drum in a buried or exposed environment is dependent on many variables including the contents of the drum, the corrosivity of the soil, and the climatological factors the drum is exposed to. The life of a steel drum can range from 3 to 15 years. The life of fiber or plastic drums is expected to be longer than that of a steel drum; however, no data are available to support this and, as with any drum, the life expectancy will be site specific.

(4) Quantification of buried waste is extremely difficult and may require interviews with site employees, and even remote sensing techniques such as ground-penetrating radar or electromagnetic surveys to confirm locations. Normally, only a minimum of this type of work would be done during a preliminary assessment.

(5) Data that will be used as the basis for decisionmaking require that the analysis of samples in laboratories meets specific quality assurance/quality control (QA/QC) requirements. To meet these requirements, Federal- or state-lead site investigations have the option of using mobile laboratories; the certified laboratory procedure (CLP) laboratory, which is established by EPA; or a non-CLP laboratory that meets the data quality objectives (DQO) of the site investigation.

b. Site Parameters. During preliminary site assessment, data on site parameters will have been collected. Most of this information will have been collected with a goal of establishing the extent of hazard. More detailed information will be needed as remedial systems are evaluated. For example,

while the initial assessment may have established that an aquifer is contaminated, later phases of the investigation will have to establish the position of the plume of contamination, the speed and direction of ground-water movement, and the interconnections present between aquifers. Initial investigations may have established the average or maximum concentration of specific contaminants; follow-up investigations may be concerned with the retention of contaminants in the soil under specific conditions. Later phases of data collection will be specifically oriented toward evaluating the use of selected treatment options. Often, samples obtained in the preliminary sampling phase of site assessment can be used to obtain more data if they are maintained in an unchanged condition. For example, if phenol-contaminated soil is being examined for possible transport and incineration, it may be vital to establish levels of refractory toxic organics such as PCB or dioxin. Waste samples already collected along with new samples can be reanalyzed using techniques providing low limits on these specific contaminants.

2-9. Data Base Development.

a. General.

(1) The preliminary site assessment documentation usually covers the sources of information specific to the nature and extent of hazard posed by the site. Table 2-5 summarizes the sources of data for site assessment. A broader data base must be developed for remedial planning. While much of the data will be developed through field investigation at the site, many critical factors related to contaminant containment or treatment will be obtained from published literature and record searches.

(2) When detailed data collection is planned, care should be taken to see that the accuracy and the extent of the data suit the need. Many of the needs in remedial action planning will arise from input parameters required for models that relate to treatment or containment programs. For example, if a water balance model is to be employed in designing a cover for a hazardous waste model, rainfall and evapotranspiration rates become critical factors as input to the model. Daily rainfall records and hourly rainfall patterns through typical storm events would be important. Data with less than this detail would not be useful. Review of modeling approaches is often a useful method of determining what is needed in data and which parameters must be known with great accuracy and where estimates can be substituted for "hard data." For example, Table 2-6 lists variables used in a hydrologic model for landfill cover design and indicates the critical or noncritical nature of each parameter. This type of model sensitivity analysis can be used where available to save time and expense in data collection.

b. Sources of Information. Preliminary data sources used in site assessment can often yield detailed information on other parameters useful in estimating the effectiveness of various treatment or containment strategies. Usually, however, much of the data must be obtained from laboratory analyses and field tests. As an example, Table 2-7 lists sources of information and systems for gathering information related to estimating vapor transfer through a soil landfill cover for a toxic organic waste.

Table 2-5. Sources of Data for Site Assessment

Substance characterization	Pollutant dispersal pathways	Receptor characterizations	Site management practices
Site records	Geology	U. S. Public Health Service	State and local regulatory offices
Inventories	Publications	Local planning agencies	Review of site management
Shipment manifests	Topographic maps	Federal/state fish and wildlife departments/agencies	Personal inter-views
Permits	USGS state geological surveys, universities	Area universities	Aerial photo
Waste generator records	Hydrology	Local naturalists	OSHA/NIOSH
Site personnel	USGS water resource divisions	Aerial imagery	Fire departments
Public officials	State water resource divisions	Medical reports	
Private citizens	Flood insurance rate maps from HUD	News sources	
Monitoring/sampling/testing data (if available)	Aerial imagery		
	EPA sources		
	Other sources		
	NASA EROS		
	Local planning agencies		
	Private companies		
	National Weather Service		
	EPA site reports		
	Corps/USGS		

Note: USGS = U.S. Geological Survey, HUD = Housing and Urban Development, NASA EROS = National Aeronautical Space Administration Earth Resources Orbital Satellite, OSHA = Occupational Safety and Health Administration, NIOSH = National Institute for Occupational Safety and Health.

Table 2-6. Example of Data Quality Variation in a Selected Number of Parameters Used in Hydrologic Simulation Models

<u>Parameter</u>	<u>Suggested source</u>	<u>Effect in model</u>
Saturated hydraulic conductivity of soil	Field or laboratory measurement	Critical; model very sensitive
Soil evaporation parameter	Estimate from soils handbook	Moderate
Soil porosity	Estimate	Not sensitive
Leaf area of plant cover	Estimate from crop information handbook	Moderately sensitive
Rainfall	Climatological data from National Weather Service	Critical
Runoff	Estimate from drainage handbook	Critical

Table 2-7. Examples of Typical Data Required to Assess Vapor Movement through a Soil Cover

<u>Parameter</u>	<u>Source of estimate</u>	<u>Measurement system</u>
Vapor diffusion coefficient for volatile organic in air (cm ² /day)	Chemical handbook	Specialized laboratory measurement using gas chromatograph/mass spectroscopy (GC/MS) analysis
Soil air-filled porosity	Estimated from porosity and water content	Measured by displacement of gas in pore spaces
Total soil porosity	Estimated from particle density and bulk density	Direct measurement by filling pore spaces
Concentration of volatiles at bottom of cover	Estimated from concentration of saturation	Measured by CC/MS techniques on soil gas
Depth of soil cover	Estimated from records	Measured in a boring

c. Data Measurement.

(1) Data collected for one phase of a remedial investigation can often be used in another phase either as an accurate measurement or as a rational estimate. It is important that site data be in an organized, transferable form, perhaps as a directory report, which should include discrete data sets relating the waste and the character of the surrounding environment.

(2) Where data are primarily numeric values (concentrations, permeabilities, inches of precipitation, etc.), computer-based data management is often the cheapest and best system for allowing rapid updating of files and multiple access. With data in a machine-readable form, implementing models for treatment or containment is rapid and inexpensive. In a similar manner, computer-based cost analysis systems can also be accessed.

(3) Analyses of the data collected should focus on the development or refinement of the conceptual site model by presenting and analyzing data on source characteristics, the nature and extent of contamination, the contaminated transport pathways and fate, and the effects on human health and the environment. Data collection and analysis for the site characterization are complete when the DQOs that were developed in scoping (including any revisions during the RI) are met, when the need (or lack thereof) for remedial actions is documented, and when the data necessary for the development and evaluation of remedial alternatives have been obtained. The results of the RI typically are presented as an analysis of site characteristics and the risk associated with such characteristics (i.e., the baseline risk assessment).

(4) An RI may generate an extensive amount of information, the quality and validity of which must be consistently well documented because this information will be used to support remedy selection decisions and any legal or cost recovery actions. Therefore, field sampling and analytical procedures for the acquisition and compilation of field and laboratory data are subject to data management procedures. The discussion on data management procedures is divided into three categories: field activities, sample management and tracking, and document control and inventory.

(5) A file structure suggested by EPA for the collected data is shown in Table 2-8. A file structure consistent with that of other agencies greatly facilitates communication.

2-10. Community Relations During Site Characterization. Two-way communication with interested members of the community should be maintained throughout the RI. The remedial project manager and community relations coordinator will keep local officials and concerned citizens apprised of site activities and of the schedule of events by implementing several community relation activities. These actions are usually delineated in the community relations plan and typically include, but are not limited to, public information meetings at the beginning and end of the RI; a series of fact sheets that will be distributed to the community during the investigation and will describe up-to-date progress and plans for remedial activities; telephone

Table 2-8. Outline of Suggested File Structure
for Superfund Sites

Congressional Inquiries and Hearings:

- ! Correspondence
- ! Transcripts
- ! Testimony
- ! Published hearing records

Remedial Response

- ! Discovery
 - Initial investigation reports
 - Preliminary assessment report
 - Site inspection report
 - Hazard Ranking System data

Remedial Planning

- Correspondence
- Work plans for RI/FS
- RI/FS reports, treatability study results
- Health and safety plan
- QA/QC plan
- Record of decision/responsiveness summary

Remedial Implementation

- Remedial design reports
- Permits
- Contractor work plans and progress reports
- Corps of Engineers agreements, reports, and correspondence

State and Other Agency Coordination

- Correspondence
- Cooperative agreement/Superfund state contract
- State quarterly reports
- Status of state assurances
- Interagency agreements
- Memorandum of Understanding with the state

Community Relations

- Interviews
- Correspondence
- Community relations plan
- List of people to contact, e.g., local officials, environmental groups
- Meeting summaries
- Press releases
- News clippings
- Fact sheets
- Comments and responses

(Continued)

Table 2-8. (Concluded)

Community Relations (continued)

- Transcripts
- Summary of proposed plan
- Responsiveness summary

Imagery:

- ! Photographs
- ! Illustrations
- ! Other graphics

Enforcement:

- ! Status reports
- ! Cross-reference to any confidential enforcement files and the person to contact
- ! Correspondence
- ! Administrative orders

Contracts

- ! Site-specific contracts
- ! Procurement packages
- ! Contract status notifications
- ! List of contractors

Financial Transactions:

- ! Cross-reference to other financial files and the person to contact
 - ! Contractor cost reports
 - ! Audit reports
-

briefings for key members of the community, public officials, and representatives of concerned citizens; and periodic news releases that describe progress at the site.

2-11. Extent of Hazard. A preliminary judgment of the extent of hazard has generally been made on any hazardous waste sites selected for remedial action. As additional data become available, the hazard assessment must be updated based on new field and laboratory data. Revised hazard estimates can be used to adjust safety planning and to refine designs for treatment and containment.

Section III. Establishment of Cleanup Criteria

2-12. Limits of Allowable Contamination Onsite and Offsite.

a. The extent of site cleanup will depend on the hazard posed by the site as judged from four major factors:

- (1) Nature of the waste.

- (2) Dispersal pathways.
- (3) Receptor characteristics.
- (4) Site management.

b. In most cases restoration of a site to a state which is equivalent to its predisposal situation will not be practical. The relationship between cost and cleanup is an ever-steepening curve with the final steps to 100 percent restoration being the most expensive. Restoration will be balanced against costs at most sites at the point where immediate adverse effects to the surrounding environment are eliminated and long-term releases and dangers of bioaccumulation of toxicants are controlled at some low level. Many sites will never reach a state of restoration where the land can be designated for unlimited use. In some cases, onsite contamination may remain at levels that require access to the site be restricted indefinitely.

2-13. Cleanup Standards.

a. Section 121 (Cleanup Standards) of CERCLA (PL 96-510) states a strong statutory preference for remedies that are highly reliable and provide long-term protection. In addition to the requirement for remedies to be both protective of human health and the environment and cost-effective, additional remedy selection considerations in Section 121(b) include:

(1) A preference for remedial actions employing treatment that permanently and significantly reduces the volume, toxicity, or mobility of hazardous substances, pollutants, and contaminants as a principal element.

(2) Offsite transport and disposal without treatment is the least favored alternative where practicable treatment technologies are available.

(3) The need to assess the use of permanent solutions and alternative treatment technologies or resource recovery technologies and use them to the maximum extent practicable.

b. Section 121(c) also requires a periodic review of remedial actions, at least every 5 years after initiation of such action, for as long as hazardous substances, pollutants, or contaminants that may pose a threat to human health or the environment remain at the site. If it is determined during a 5-year review that the action no longer protects human health and the environment, further remedial actions will need to be considered.

2-14. Applicable or Relevant and Appropriate Requirements (ARARs).

a. Statutes. Section 121(d)(2)(A) of CERCLA incorporates into law the CERCLA compliance policy, which specifies that Superfund remedial actions meet any Federal standards, requirements, criteria, or limitations that are determined to be legally applicable or relevant and appropriate requirements (ARARs). Also included is the new provision that state ARARs must be met if they are more stringent than Federal requirements. Federal statutes that are

specifically cited in CERCLA include the Solid Waste Disposal Act (SWDA), the Toxic Substances Control Act (TSCA), the Safe Drinking Water Act (SDWA), the Clean Air Act (CAA), the Clean Water Act (CWA), and the Marine Protection Research and Sanctuaries Act (MPRSA). Additional guidance on ARARs is provided in the "CERCLA Compliance with Other Statutes" manual (EPA, Draft, August 1988).

b. Waivers. Section 121(d) (4) of CERCLA identifies six circumstances under which ARARs may be waived:

(1) The remedial action selected is only a part of a total remedial action (interim remedy) and the final remedy will attain the ARAR upon its completion.

(2) Compliance with the ARAR will result in a greater risk to human health and the environment than alternative options.

(3) Compliance with the ARAR is technically impracticable from an engineering perspective.

(4) An alternative remedial action will attain an equivalent standard of performance through the use of another method or approach.

(5) The ARAR is a state requirement that the state has not consistently applied (or demonstrated the intent to apply consistently) in similar circumstances.

(6) For Section 104 Superfund-financed actions, compliance with the AFAR will not provide a balance between protecting human health and the environment and the availability of Superfund money for response at other facilities.

2-15. Risk Assessment.

a. Purpose. Risk assessments provide an evaluation of the potential threat to human health and the environment in the absence of any remedial action. They provide the basis for determining whether or not remedial action is necessary and the justification for performing remedial actions. The baseline risk assessment will also be used to support a finding of imminent and substantial endangerment if such a finding is required as part of an enforcement action. Detailed guidance on evaluating potential human health impacts as part of this baseline assessment is provided in the Superfund Public Health Evaluation Manual (EPA, October 1986). Guidance for evaluating ecological risks is currently under development within U.S. EPA, Office of Solid Waste and Emergency Response (OSWER).

b. Objectives. In general., the objectives of a risk assessment may be attained by identifying and characterizing the following:

(1) Toxicity and levels of hazardous substances present in relevant media (e.g. , air, ground water, soil, surface water, sediment, and biota).

(2) Environmental fate and transport mechanisms within specific environmental media such as physical, chemical, and biological degradation processes and hydrogeological conditions.

(3) Potential human and environmental receptors.

(4) Potential exposure routes and extent of actual or expected exposure.

(5) Extent of expected impact or threat; and the likelihood of such impact or threat occurring (i.e., risk characterization).

(6) Level of uncertainty associated with the above items.

c. Effort Required. The level of effort required to conduct a risk assessment depends largely on the complexity of the site. The goal is to gather sufficient information to adequately and accurately characterize the potential risk from a site, while at the same time conduct this assessment as efficiently as possible. Use of the conceptual site model developed and refined previously will help focus investigation efforts and, therefore, streamline this effort. Factors that may affect the level of effort required include:

(1) The number, concentration, and types of chemicals present.

(2) Areal extent of contamination.

(3) The quality and quantity of available monitoring data.

(4) The number and complexity of exposure pathways (including the complexity of release sources and transport media)

(5) The required precision of sample analyses, which in turn depends on site conditions such as the extent of contaminant migration and the proximity, characteristics, and size of potentially exposed populations.

(6) The availability of appropriate standards and/or toxicity data.

d. Components. The risk assessment process can be divided into four components:

(1) Contaminant identification.

(2) Exposure assessment.

(3) Toxicity assessment.

(4) Risk characterization.

e. Overview. Figure 2-10 illustrates the risk assessment process and its four components. A brief overview of each component follows.

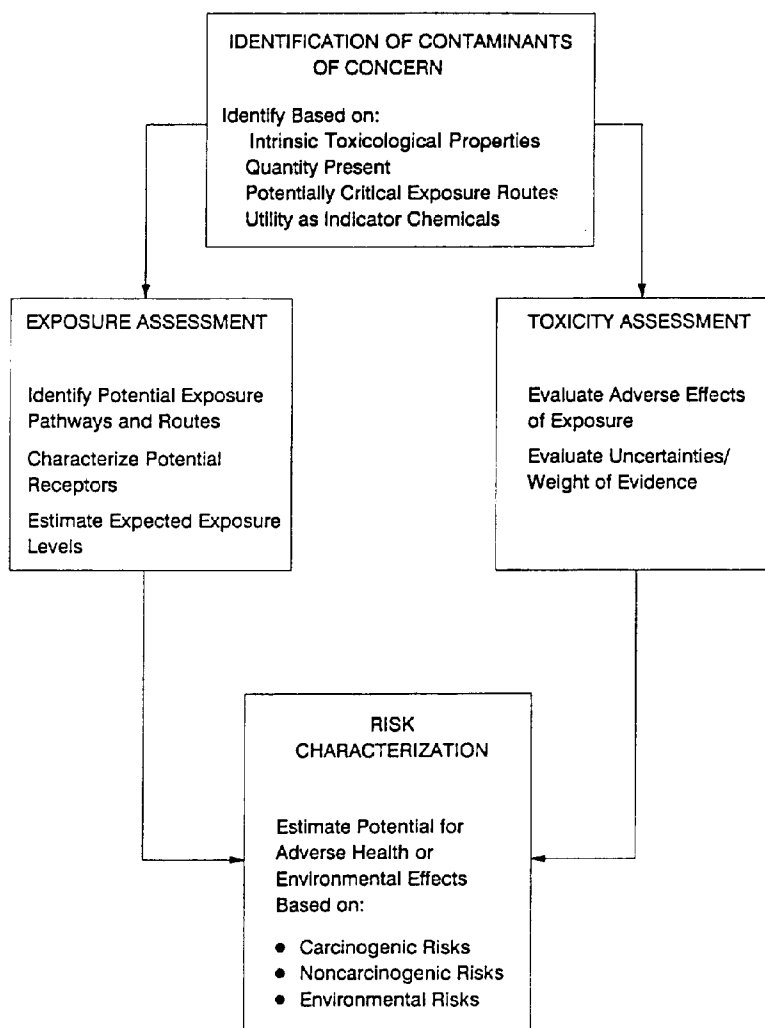

Figure 2-10. Overview of the Risk Assessment Process

(1) Contaminant identification.

(a) The objective of contaminant identification is to screen the information that is available on hazardous substances or wastes present at the site and to identify contaminants of concern to focus subsequent efforts in the risk assessment process. Contaminants of concern may be selected because of their intrinsic toxicological properties, because they are present in large

quantities, or because they are presently in or potentially may move into critical exposure pathways (e.g., drinking water supply).

(b) At some sites it may be useful to select "indicator chemicals." Indicator chemicals are chosen to represent the most toxic, persistent, and/or mobile substances among those identified that are likely to significantly contribute to the overall risk posed by the site. In some instances, an indicator chemical may be selected for the purpose of representing a "class" of chemicals (e.g., TCE to represent all volatiles). Although the use of indicator chemicals serves to focus and streamline the assessment on those chemicals that are likely to be of greatest concern, a final check must be made during remedy selection and the remedial action phase to ensure that the waste management strategy being implemented addresses risks posed by the range of contaminants found at the site.

(2) Exposure assessment.

(a) The objectives of an exposure assessment are to identify actual or potential exposure pathways, to characterize the potentially exposed populations, and to determine the extent of the exposure. Detailed guidance on conducting exposure assessments is provided in the Superfund Exposure Assessment Manual (U.S. EPA, April 1988), and is briefly discussed below.

(b) Identifying potential exposure pathways helps to conceptualize how contaminants may migrate from a source to an existing or potential point of contact. An exposure pathway may be viewed as consisting of four elements:

! A source and mechanism of chemical release to the environment;

! An environmental transport medium (e.g., air, ground water) for the released chemical;

! A point of potential contact with the contaminated medium (referred to as the exposure point); and

! An exposure route (e.g., inhalation, ingestion) at the exposure point.

(c) The analysis of the contaminant source and how contaminants may be released involves characterizing the contaminants of concern at the site and determining the quantities and concentrations of contaminants released to environmental media. Figure 2-11 presents a conceptual example identifying actual and potential exposure pathways.

(d) Once the source and release mechanisms have been identified, an analysis of the environmental fate and transport of the contaminants is conducted. This analysis considers the potential environmental transport (e.g., ground-water migration, airborne transport); transformation (e.g., biodegradation, hydrolysis, and photolysis); and transfer mechanisms (e.g., sorption, volatilization) to provide information on the potential magnitude and extent of environmental contamination. The actual or potential exposure points for receptors are identified. The focus of this effort should be on

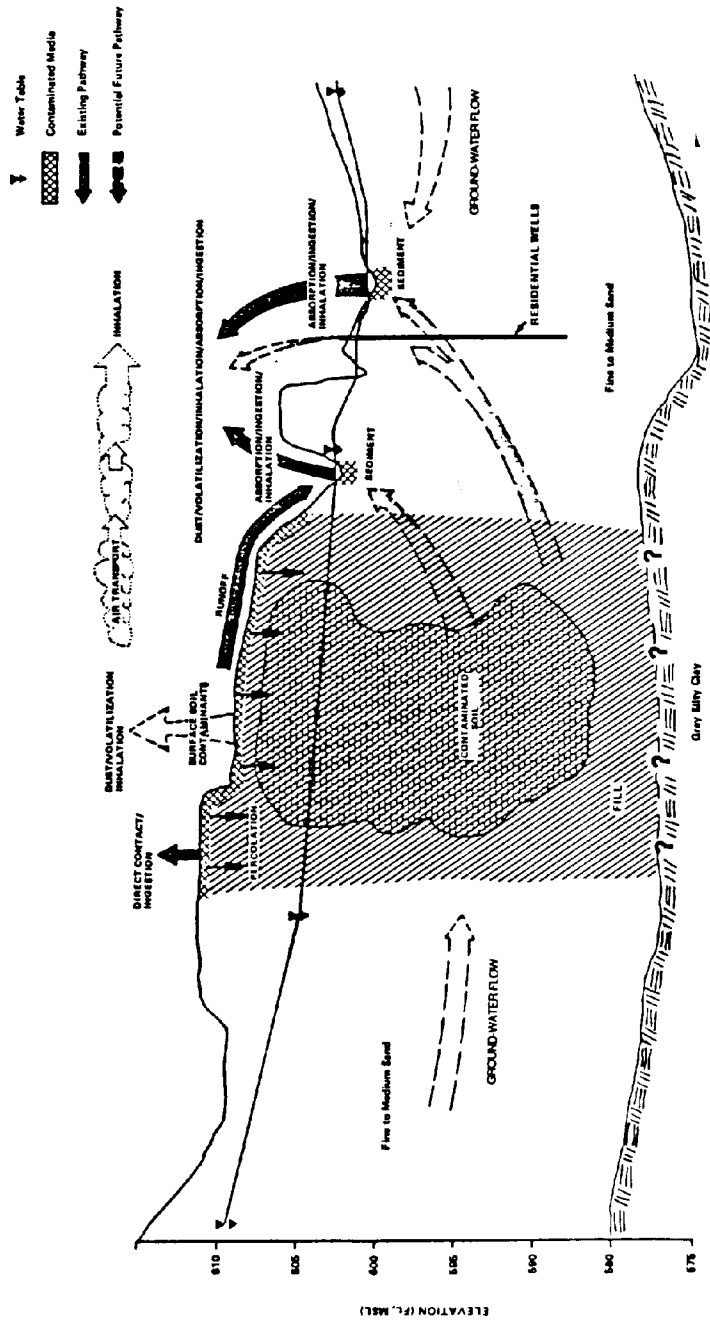

Figure 2-11. Identification of Exposure Pathways

those locations where actual contact with the contaminants of concern will occur or is likely to occur. Potential exposure routes that describe the potential uptake mechanism (e.g., ingestion, inhalation, etc.) once a receptor comes into contact with contaminants in a specific environmental medium are identified and described. Environmental media that may need to be considered include air, ground water, surface water, soil and sediment, and food sources. Detailed procedures for estimating and calculating rates of exposure are described in detail in the Superfund Exposure Assessment Manual.

(e) After the exposure pathway analysis is completed, the potential for exposure should be assessed. Information on the frequency, mode, and magnitude of exposure should be gathered. These data are then assessed to yield a value that represents the amount of contaminated media contacted per day. This analysis should include not only identification of current exposures but also exposures that may occur in the future if no action is taken at the site. Because the frequency mode and magnitude of human exposures will vary based on the primary use of the area (e.g., residential, industrial, or recreational), the expected use of the area in the future should be evaluated. The purpose of this analysis is to provide decisionmakers with an understanding of both the current risks and potential future risks if no action is taken. Therefore, as part of this evaluation, a reasonable maximum exposure scenario should be developed, which reflects the type and extent of exposures that could occur based on the likely or expected use of the site (or surrounding areas) in the future. The reasonable maximum exposure scenario is presented to the decisionmaker so that possible implications of decisions regarding how to best manage uncertainties can be factored into the risk management remedy selection.

(f) The final step in the exposure assessment is to integrate the information and develop a qualitative and/or quantitative estimate of the expected exposure level resulting from the actual or potential release of contaminants from the site.

(3) Toxicity assessment.

(a) Toxicity assessment, as part of the Superfund baseline risk assessment process, considers the types of adverse health or environmental effects associated with individual and multiple chemical exposures; the relationship between magnitude of exposures and adverse effects; and related uncertainties such as the weight of evidence for a chemical's potential carcinogenicity in humans. Detailed guidance for conducting toxicity assessments is provided in the Superfund Public Health Evaluation Manual.

(b) Typically, the risk assessment process relies heavily on existing toxicity information and does not involve the development of new data on toxicity or dose-response relationships. Available information on many chemicals is already evaluated and summarized by various EPA program offices or cross-Agency work groups in health and environmental effects assessment documents. These documents or profiles will generally provide sufficient toxicity and dose-response information to allow both qualitative and quantitative estimates of risks associated with many chemicals found at Superfund sites. These documents often estimate carcinogen exposures

associated with specific lifetime cancer risks (e.g., risk-specific doses or RSDs), and systemic toxicant exposures that are not likely to present appreciable risk of significant adverse effects to human populations over a lifetime (e.g., reference doses or RfDs).

(4) Risk characterization.

(a) In the final component of the risk assessment process, a characterization of the potential risks of adverse health or environmental effects for each of the exposure scenarios derived in the exposure assessment, is developed and summarized. Estimates of risks are obtained by integrating information developed during the exposure and toxicity assessments to characterize the potential or actual risk, including carcinogenic risks, noncarcinogenic risks, and environmental risks. The final analysis should include a summary of the risks associated with a site.

(b) Characterization of the environmental risks involves identifying the potential exposures to the surrounding ecological receptors and evaluating the potential effects associated with such exposure. Important factors to consider include disruptive effects to populations (both plant and animal) and the extent of perturbations to the ecological community.

(c) The results of the baseline risk assessment may indicate that the site poses little or no threat to human health or the environment. In such situations, the FS should be either scaled down to that site and its potential hazard, or eliminated altogether. The results of the RI and the baseline risk assessment will therefore serve as the primary means of documenting a no-action decision. If it is decided that the scope of the FS will be less than what is presented in this guidance or eliminated altogether, the lead agency should document this decision and receive the concurrence of the support agency.

2-16. Technological Limitations on Cleanup. In some cases, the technology to handle the total cleanup of a site may not exist. For example, where contamination of a subsurface aquifer has occurred, it may be impossible to flush all contaminants out of the porous geologic units simply because of the limited access any flushing agent has to pore space in the units. In other instances, the reactions (adsorption, precipitation, etc.) used to remove a contaminant from surface water may not be efficient enough to restore the water to its precontamination condition.

Section IV. Alternative Development and Screening

2-17. Developing Options.

a. The primary objective of alternative development and screening is to develop a range of waste management options that will be analyzed more fully in the detailed analysis phase. Waste management options that ensure the protection of human health and the environment may involve, depending on site-specific circumstances, complete elimination or destruction of hazardous substances at the site, reduction of concentrations of hazardous substances to acceptable health-based levels, and prevention of exposure to hazardous

substances via engineering or institutional controls, or some combination of the above.

b. Alternatives are typically developed concurrently with the RI site characterization, with the results of one influencing the other in an iterative fashion. RI site characterization data are used to develop alternatives and screen technologies, whereas the range of alternatives developed guides subsequent site characterization and/or treatability studies. Table 2-9 summarizes important site characteristics affecting selection of remedial measures.

2-18. Alternative Development Process.

a. Analytical Steps. The alternative development process may be viewed as a series of six analytical steps that involve making successively more specific definitions of potential remedial activities. Alternatives for remediation are developed by assembling combinations of technologies, and the media to which they would be applied, into alternatives that address contamination on a sitewide basis or for an identified operable unit. These steps are shown in Figure 2-12 and discussed below.

(1) Develop remedial action objectives specifying the contaminants and media of interest, exposure pathways, and preliminary remediation goals that permit a range of treatment and containment alternatives to be developed. The preliminary remediation goals are developed on the basis of chemical-specific ARARs, other available information (e.g., Rfds), and site-specific risk-related factors. These preliminary remediation goals are reevaluated as site characterization data and information from the baseline risk assessment become available.

(2) Develop general response actions for each medium of interest defining containment, treatment, excavation, pumping, or other actions, singly or in combination, that may be taken to satisfy the remedial action objectives for the site.

(3) Identify volumes or areas of media to which general response actions might be applied, taking into account the requirements for protectiveness as identified in the remedial action objectives and the chemical and physical characterization of the site.

(4) Identify and screen the technologies applicable to each general response action to eliminate those that cannot be implemented technically at the site. It is important to distinguish between this medium-specific technology screening step during development of alternatives and the alternative screening that may be conducted subsequently to reduce the number of alternatives prior to the detailed analysis. The general response actions are further defined to specify remedial technology types (e.g., the general response action of treatment can be further defined to include chemical or biological technology types).

(5) Identify and evaluate technology process options to select a representative process for each technology type retained for consideration.

Although specific processes are selected for alternative development and evaluation, these processes are intended to represent the broader range of process options within a general technology type.

(6) Assemble the selected representative technologies into alternatives representing a range of treatment and containment combinations.

b. Develop Remedial Action Objectives.

(1) Remedial action objectives consist of medium-specific or operable unit-specific goals for protecting human health and the environment. The objectives should be as specific as possible but not so specific that the range of alternatives that can be developed is unduly limited. Column two of Table 2-10 provides examples of remedial action objectives for various media. Remedial action objectives aimed at protecting human health and the environment should specify the following.

(a) The contaminant of concern.

(b) Exposure route and receptor.

(c) An acceptable contaminant level or range of levels for each exposure route (i.e., a preliminary remediation goal).

(2) Remedial action objectives for protecting human receptors should express both a contaminant level and an exposure route, rather than contaminant levels alone, because protectiveness may be achieved by reducing exposure (such as capping an area, limiting access, or providing an alternate water supply) as well as by reducing contaminant levels. Because remedial action objectives for protecting environmental receptors typically seek to preserve or restore a resource (e.g., as ground water), environmental objectives should be expressed in terms of the medium of interest and target cleanup levels, whenever possible.

(3) Although the preliminary remediation goals are established on readily available information [e.g., reference doses (RfDs) and risk-specific doses (RSDs)] or frequently used standards (e.g., ARARs), the final acceptable exposure levels should be determined on the basis of the results of the baseline risk assessment and the evaluation of the expected exposures and associated risks for each alternative. Contaminant levels in each media should be compared with these acceptable levels and include an evaluation of the following factors:

(a) Whether the remediation goals for all carcinogens of concern, including those with goals set at the chemical-specific ARAR level, provide protection within the risk range of 10^{-4} to 10^{-7} .

Table 2-9. Important Site Characteristics and Considerations Affecting Selection of Remedial Measures

<u>Site characteristics</u>	<u>Considerations</u>
<u>Waste characteristics</u>	
Quantity	Determines volume and size of area, affects costs
Chemical makeup	Determines transport paths, materials of construction
Toxicity	High toxicity calls for immediate action, worker safety
Persistence/ biodegradability	Resists decomposition/can be treated by biodegradation
Radioactive	Requires special materials of construction, worker safety, site security
Reactivity/ corrosiveness	Requires special materials of construction, potential explosion
Infectiousness	Calls for immediate action, worker safety
Solubility	Affects hydrology migration
Volatility	Affects migration in gaseous state
<u>Climate</u>	
Precipitation	Humid areas - abundant surface water, shallow ground-water table Arid areas - high wind and water erosion potential, deep groundwater table
Temperature	Affects physical processes such as rates of reaction, volatilization, sealed container pressure as well as microbial degradation and transformation processes

(Continued)

Table 2-9. (Continued)

<u>Site characteristics</u>	<u>Considerations</u>
<u>Surface characteristics</u>	
Soil texture and permeability	Coarse-textured (sandy) soils have greater permeability and transmit liquid and gases faster than fine-textured (clay) soils
Soil moisture content	Wet soils are less permeable to gases than dry soils
Slope	Steeper slopes have greater runoff, less infiltration
	Very steep or unbroken slopes have high erosion potential
Vegetation	Increases infiltration, decreases erosion
<u>Subsurface characteristics</u>	
Depths of ground water	Deep - higher pumping costs
	Shallow - may require lowering water table
Permeability	Permeable soils readily transmit water and gases
	Low permeability causes difficulty in pumping; drainage
Depths to bedrock	Shallow impermeable bedrock may cause leachate surface seepage; shallow or deep permeable bedrock may cause rapid and extensive contaminant migration
	Deep - limit on trench excavation depth
Direction of ground-water flow and points of discharge	Direction of flow toward point of use presents a significantly adverse impact; point of discharge must be known to assess areal extent of contamination and degree of impact

(Continued)

Table 2-9. (Concluded)

<u>Site characteristics</u>	<u>Considerations</u>
<u>Receptors</u>	Nearby working and residential populations, farms, orchards, grazing lands, natural areas, critical habitats may require immediate relief
<u>Existing land use</u>	Maintenance of site security, protection of equipment, and soil cover from accidental abuse; vandalism

(b) Whether the remediation goals set for all noncarcinogens of concern, including those with goals set at the chemical-specific ARAR level, are sufficiently protective at the site.

(c) Whether environmental effects (in addition to human health effects) are adequately addressed.

(d) Whether the exposure analysis conducted as part of the risk assessment adequately addresses each significant pathway of human exposure identified in the baseline risk assessment. For example, if the exposures from the ingestion of fish and drinking water are both significant pathways of exposure, goals set by considering only one of these exposure pathways may not be adequately protective. The Superfund Public Health Evaluation Manual (SPHEM) provides additional details on establishing acceptable exposure levels.

c. Develop General Response Actions.

(1) General response actions describe those actions that will satisfy the remedial action objectives. General response actions may include treatment, containment, excavation, extraction, disposal, institutional actions, or a combination of these. Like remedial action objectives, general response actions are medium specific.

(2) General response actions that might be used at a site are initially defined during scoping and are refined throughout the RI/FS as a better understanding of site conditions is gained and action-specific ARARs are identified. In developing alternatives, combinations of general response actions may be identified, particularly when disposal methods primarily depend on whether the medium has been previously treated. Examples of potential general response actions are included in column three of Table 2-10.

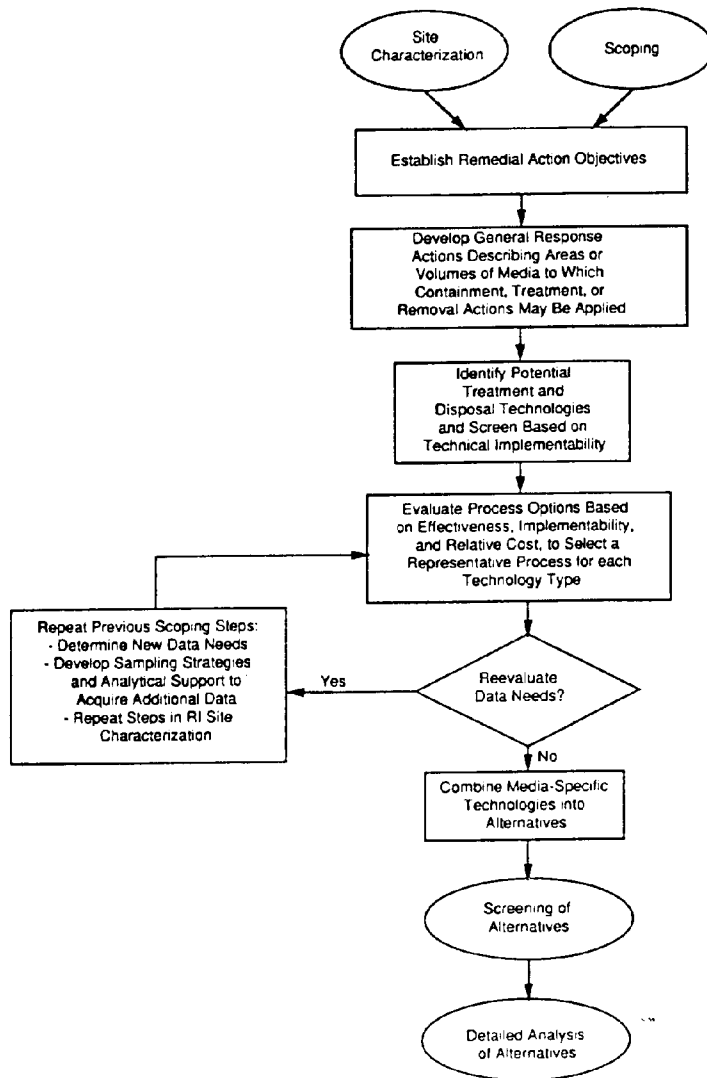

Figure 2-12. Alternative Development and Screening

Table 2-10. Example of Remedial Action Objectives, General Response Actions, Technology Types, and Example Process Options for the Development and Screening of Technologies

Environmental media	Remedial action objectives (from site characterization)	General response actions (for all remedial action objectives)	Remedial technology types (for general response actions)	Process options
Ground Water	<u>For Human Health:</u> Prevent ingestion of water having [carcinogen(s)] in excess of [MCL(s)] and a total excess cancer risk (for all contaminants) of greater than 10^{-4} to 10^{-6} .	No Action/Institutional Actions: No Action Alternative residential water supply Monitoring Containment Actions: Containment Collection/Treatment Actions: Collection/treatment discharge/in situ ground-water treatment Individual home treatment units	No Action/Institutional options: Fencing Deed restrictions Containment Technologies: Capping Vertical barriers Horizontal barriers Extraction Technologies: Ground-water collection/pumping Enhanced removal	Clay cap, synthetic membrane, multi-layer slurry wall, sheet piling liners, grout injection Wells, subsurface or leachate collection Solution mining, vapor extraction, enhanced oil recovery
	<u>For Environmental Protection:</u> Restore ground-water aquifer to [concentration(s)] for [contaminant(s)].		Treatment Technologies: Physical treatment Chemical treatment In situ treatment	Coagulation/flocculation, oil-water separation, air stripping, adsorption. Neutralization, precipitation, ion exchange oxidation/reduction. Subsurface bioreclamation
			Disposal Technologies: Discharge to POTW (after treatment) Discharge to surface water (after treatment)	

(Continued)

Table 2-10. (Continued)

Environmental media	Remedial action objectives (from site characterization)	General response actions (for all remedial action objectives)	Remedial technology types (for general response actions)	Process options
Soil	<p><u>For Human Health:</u></p> <p>Prevent ingestion/direct contact with soil having [noncarcinogen(s)] in excess of [reference dose(s)].</p> <p>Prevent direct contact/ingestion with soil having 10^{-4} to 10^{-7} excess cancer risk from [carcinogen(s)].</p>	<p>No Action/Institutional Actions:</p> <p>No action</p> <p>Access restrictions</p> <p>Containment Actions:</p> <p>Containment</p>	<p>No Action/Institutional options:</p> <p>Fencing</p> <p>Deed restrictions</p> <p>Containment Technologies:</p> <p>Capping</p> <p>Vertical barriers</p> <p>Horizontal barriers</p> <p>Surface controls</p>	<p>Clay cap, synthetic membrane, multilayer slurry wall, sheet piling liners, grout injection diversion/ collection, grading, soil stabilization</p> <p>Coffer dams, curtain barriers</p> <p>Revegetation, capping</p>
	<p>Prevent inhalation of [carcinogen(s)] posing excess cancer risk levels of 10^{-4} to 10^{-7}.</p>	<p>Excavation/Treatment Actions:</p> <p>Excavation/treatment/disposal</p> <p>In situ treatment</p> <p>Disposal excavation</p>	<p>Removal Technologies:</p> <p>Excavation</p> <p>Treatment Technologies:</p> <p>Solidification, fixation</p> <p>stabilization, immobilization</p> <p>Dewatering</p>	<p>Solids excavation</p> <p>Sorption, pozzolanic agents, encapsulation</p> <p>Belt filter press, dewatering, and drying beds</p>
	<p><u>For Environmental Protection:</u></p> <p>Prevent migration of contaminants that would result in ground-water contamination in excess of [concentration(s)] for [contaminant(s)].</p>	<p>Physical treatment</p> <p>Chemical treatment</p> <p>Biological treatment</p> <p>In situ treatment</p> <p>Thermal treatment</p>	<p>Water/solvent leaching (with subsequent liquids treatment)</p> <p>Lime neutralization</p> <p>Cultured micro-organisms</p> <p>Surface bioreclamation</p> <p>Incineration, pyrolysis</p>	

(Continued)

Table 2-10. (Continued)

Environmental media	Remedial action objectives (from site characterization)	General response actions (for all remedial action objectives)	Remedial technology types (for general response actions)	Process options
Surface Water	<p><u>For Human Health:</u></p> <p>Prevent ingestion of water having [carcinogen(s)] in excess of [MCLs] and a total excess cancer risk of greater than 10^{-4} to 10^{-7}.</p> <p>Prevent ingestion of water having [noncarcinogen(s)] in excess of [MCLs] or [reference dose(s)].</p>	<p>No Action/Institutional Actions:</p> <p>No action Access restrictions Monitoring</p> <p>Collection/Treatment Actions: Surface water runoff interception/treatment/discharge</p>	<p>No Action/Institutional Options:</p> <p>Fencing Deed restrictions</p> <p>Collection Technologies: Surface controls</p> <p>Treatment Technologies: Physical treatment</p> <p>Chemical treatment</p>	<p>Grading, diversion, and collection</p> <p>Coagulation/flocculation, oil-water separation, filtration, adsorption</p> <p>Precipitation, ion exchange, neutralization, freeze crystallization</p> <p>Aerobic and anaerobic spray irrigation</p> <p>In situ precipitation, in situ bioreclamation</p>
	<p><u>For Environmental Protection:</u></p> <p>Restore surface water to [ambient water quality criteria] for [contaminant(s)]</p>		<p>Biological treatment (organics)</p> <p>In situ treatment</p> <p>Disposal Technologies: Disposal Technologies: Discharge to POTW (after treatment)</p>	
	<p><u>For Human Health:</u></p> <p>Prevent inhalation of [carcinogen(s)] in excess of 10^{-4} to 10^{-7} excess cancer risk.</p>	<p>No Action/Institutional Action: No action Access restrictions to Monitoring</p> <p>Collection Actions: Gas collection</p>	<p>No Action/Institutional options: Fencing Deed restrictions</p> <p>Removal Technologies: Landfill gas collection</p>	<p>Passive vents, active gas collection systems</p>

(Continued)

Table 2-10. (Continued)

Environmental media	Remedial action objectives (from site characterization)	General response actions (for all remedial action objectives)	Remedial technology types (for general response actions)	Process options
Sediment	<p><u>For Human Health:</u> Prevent direct contact with sediment having [carcinogen(s)] in excess of 10⁻⁴ to 10⁻⁷ excess cancer risk.</p>	<p>No Action/Institutional Action: No action Access restrictions to Monitoring Excavation Actions: Excavation</p>	<p>No Action/Institutional Options: Fencing Deed restrictions</p>	
	<p><u>For Environmental Protection:</u> Prevent releases of [contaminant(s)] from sediments that would result in surface water levels in excess of [ambient water quality criteria].</p>	<p>Excavation/Treatment Actions: Removal/disposal Removal/treatment/disposal</p>	<p>Removal Technologies: Excavation Containment Technologies: Capping Vertical barriers Horizontal barriers Sediment control barriers</p> <p>Treatment Technologies Solidification, fixation, stabilization Dewatering Physical treatment</p> <p>Chemical treatment</p> <p>Biological treatment In situ treatment Thermal treatment</p>	<p>Sediments excavation</p> <p>Removal with clay cap, multilayer, asphalt Slurry wall, sheet piling liners, grout injection Coffer dams, curtain barriers, capping barriers Sorption, pozzolanic agents, encapsulation Sedimentation, dewatering and drying beds Water/solids leaching with subsequent treatment) Neutralization, oxidation, electro-chemical reduction Landfarming Surface bioreclamation Incineration, pyrolysis</p>

(Continued)

Table 2-10. (Continued)

Environmental media	Remedial action objectives (from site characterization)	General response actions (for all remedial action objectives)	Remedial technology types (for general response actions)	Process options
Structures	<p><u>For Human Health:</u></p> <p>Prevent direct contact with [carcinogen(s)] in excess of 10⁻⁴ to 10⁻⁷ excess cancer risk.</p> <p>Prevent migration of [carcinogen(s)] which would result in ground-water concentrations in excess of [MCLs] or 10⁻⁴ to 10⁻⁷ total excess cancer risk level.</p> <p>Prevent migration of [carcinogen(s)] which would result in soil concentration in excess of [reference dose(s)]</p>	<p><u>No Action/Institutional Action:</u></p> <p>No action Access restrictions Demolition/Treatment Actions: Demolition/disposal Decontamination</p>	<p><u>No Action/Institutional Options:</u></p> <p>Fencing Deed restrictions</p> <p><u>Removal Technologies:</u></p> <p>Demolition Excavation Treatment Technologies: Solids processing Solids treatment</p>	<p>Demolition Excavation, debris removal Magnetic processes, crushing and grinding, screening Water leaching, solvent leaching, steam cleaning</p>
	<p><u>For Environmental Protection</u></p> <p>Prevent migration of [contaminants] that would result in ground-water concentrations in excess of [concentration(s)].</p>			

(Continued)

Table 2-10. (Continued)

Environmental media	Remedial action objectives (from site characterization)	General response actions (for all remedial action objectives)	Remedial technology types (for general response actions)	Process options
Solid Wastes	<u>For Human Health:</u> Prevent ingestion/direct contact with wastes having [non-carcinogen(s)] in excess of [reference dose(s)].	No Action/Institutional Actions: No action Access restrictions to [location] Containment Actions: Containment	No Action/Institutional Options: Fencing Deed restrictions Containment Technologies: Capping Vertical barriers Horizontal barriers	Clay cap, synthetic membranes, multi-layer slurry wall, sheet piling liners, grout injection Dust controls
	Prevent ingestion/direct contact with wastes having 10^{-4} to 10^{-7} excess cancer risk from [carcinogen(s)].	Excavation/Treatment Actions: Removal/disposal Removal/treatment/disposal	Removal Technologies: Excavation Drum removal Treatment Technologies: Physical treatment	Solids excavation Drum and debris removal Water/solvent leaching (with subsequent liquids treatment) Neutralization Cultured micro-organisms Incineration, pyrolysis, gaseous incineration Crushing and grinding, screening, classification
	Prevent inhalation of [carcinogen(s)] posing excess cancer risk levels of 10^{-4} to 10^{-7} .		Chemical treatment Biological treatment Thermal treatment Solids processing	
	Prevent migration of [carcinogen(s)] which would result in ground-water concentrations in excess of [MCLs] or 10^{-4} to 10^{-7} total excess cancer risk levels.			
	<u>For Environmental Protection:</u> Prevent migration of contaminants which would result in ground water contamination in excess of [concentration(s)] for [contaminant(s)].			

(Continued)

Table 2-10. (Continued)

Environmental media	Remedial action objectives (from site characterization)	General response actions (for all remedial action objectives)	Remedial technology types (for general response actions)	Process options
Liquid Wastes	<u>For Human Health:</u>	No Action/Institutional Actions: No action	No Action/Institutional Options: Fencing	
	Prevent ingestion/direct contact with wastes having [noncarcinogen(s)] in excess of [reference does(s)].	Access restrictions to [location] Containment Actions: Containment	Deed restrictions Containment Technologies: Vertical barriers Horizontal barriers	Slurry wall Liners
	Prevent ingestion/direct contact with wastes having 10^{-4} to 10^{-7} excess cancer risk from [carcinogen(s)].	Removal/Treatment Actions: Removal/disposal Removal/treatment/disposal	Removal Technologies: Bulk liquid removal Drum removal Treatment Technologies: Physical treatment	Bulk liquid removal Drum removal Coagulation/flocculation, adsorption, evaporation, distillation Neutralization, reduction, photolysis Aerobic/anaerobic biological treatment, biotechnologies Incineration, pyrolysis, co-disposal
	Prevent inhalation of [carcinogen(s)] posing excess cancer risk levels of 10^{-4} to 10^{-7} .		Chemical treatment Biological treatment	
	Prevent migration of [carcinogen(s)] which would result in ground-water concentrations in excess of [MCLs] or 10^{-4} to 10^{-7} total excess cancer risk levels.		Thermal treatment (organics) Disposal Technologies: Product reuse Discharge to POTW (after treatment)	
	<u>For Environmental Protection:</u>			
	Prevent migration of contaminants that would result in ground-water contamination in excess of [contaminant(s)] for [contaminant(s)].			

(Continued)

Table 2-10. (Concluded)

Environmental media	Remedial action objectives (from site characterization)	General response actions (for all remedial action objectives)	Remedial technology types (for general response actions)	Process options
Sludges	<u>For Human Health:</u>	No Action/Institutional Actions: No action Access restrictions to [location]	No Action/Institutional Options: Fencing Deed restrictions	
	Prevent direct contact with sludge having [carcinogen(s)] in excess of 10^{-4} to 10^{-5} excess cancer risk.	Containment Actions: Containment	Containment Technologies: Vertical barriers Horizontal barriers	Slurry wall, sheet piling liners
	Prevent ingestion/contact with sludge having [noncarcinogen(s)] in excess of [reference dose(s)].	Removal/Treatment Actions: Removal/disposal	Removal Technologies: Bulk sludge removal Drum removal Treatment Technologies: Solidification, fixation	Semisolid excavation, pumping Drum removal Sorption, pozzolanic agents, encapsulation freeze crystallization, neutralization, oxidation, electrochemical reduction Oxidation, reduction, photolysis Aerobic/anaerobic treatment, land treatment, new treatment technologies Incineration, pyrolysis, co-disposal Gravity thickening, belt filter press, vacuum filtration
	Prevent migration of [carcinogen(s)] which would result in ground-water concentrations in excess of 10^{-4} to 10^{-5} excess cancer risk.	Removal/treatment/disposal	Physical Treatment Chemical treatment Biological treatment Thermal treatment (organics) Dewatering	
	<u>For Environmental Protection:</u>		Disposal Technologies: Product reuse Landfilling (after treatment)	
	Prevent releases of [contaminant(s)] from sludge that would result in surface water levels in excess of [ambient water quality criteria].			
	Prevent releases of [contaminant(s)] from sludge that would result in ground-water levels of [contaminant(s)] in excess of [concentration(s)].			

d. Identify Volumes or Areas of Media.

(1) During the development of alternatives, an initial determination is made of areas or volumes of media to which general response actions might be applied. This initial determination is made for each medium of interest at a site. To take interactions between media into account, response actions for areas or volumes of media are often refined after sitewide alternatives have been assembled.

(2) Defining the areas or volumes of media requires careful judgment and should include a consideration of not only acceptable exposure levels and potential exposure routes, but also site conditions and the nature and extent of contamination. For example, in an area in which contamination is homogeneously distributed in a medium, discrete risk levels (e.g., 10^{-5} , 10^{-6}) or corresponding contaminant levels may provide the most rational basis for defining areas or volumes of media to which treatment, containment, or excavation actions may be applied. For sites with discrete hot spots or areas of more concentrated contamination, however, it may be more useful to define areas and volumes for remediation on the basis of the site-specific relationship of volume (or area) to contaminant level. Therefore, when areas or volumes of media are defined on the basis of site-specific considerations such as volume versus concentration relationships, the volume or area addressed by the alternative should be reviewed with respect to the remedial action objectives to ensure that alternatives can be assembled to reduce exposure to protective levels.

e. Identify and Screen Remedial Technologies and Process Options.

(1) In this step, the universe of potentially applicable technology types and process options is reduced by evaluating the options with respect to technical implementability. The term "technology types" refers to general categories of technologies, such as chemical treatment, thermal destruction, immobilization, capping, or dewatering. The term "technology process options" refers to specific processes within each technology type. For example, the chemical treatment technology type would include such process options as precipitation, ion exchange, and oxidation/reduction. As shown in columns four and five of Table 2-10, several broad technology types may be identified for each general response action, and numerous technology process options may exist within each technology type.

(2) Technology types and process options may be identified by drawing on a variety of sources including references developed for application to Superfund sites and more standard engineering texts not specifically directed toward hazardous waste sites.

(3) During this screening step, process options and entire technology types are eliminated from further consideration on the basis of technical implementability. This is accomplished by using readily available information from the RI site characterization on contaminant types and concentrations and onsite characteristics to screen out technologies and process options that cannot be effectively implemented at the site.

(4) Two factors that commonly influence technology screening are the presence of inorganic contaminants, which limit the applicability of many types of treatment processes, and the subsurface conditions, such as depth to impervious formations or the degree of fracture in bedrock, which can limit many types of containment and ground-water collection technologies. This screening step is site specific, however, and other factors may need to be considered.

f. Evaluate Technology Options.

(1) Representative processes. The technology processes considered to be implementable are evaluated in greater detail before selecting one process to represent each technology type. One representative process is selected, if possible, for each technology type to simplify the subsequent development and evaluation of alternatives without limiting flexibility during remedial design. The representative process provides a basis for developing performance specifications during preliminary design; however, the specific process actually used to implement the remedial action at a site may not be selected until the remedial design phase. More than one process option may be selected for a technology type if two or more processes are sufficiently different in their performance that one would not adequately represent the other.

(2) Option criteria. Process options are evaluated using the same criteria, effectiveness, implementability, and cost, that are used to screen alternatives prior to the detailed analysis. These criteria are applied only to technologies and the general response actions they are intended to satisfy and not to the site as a whole. Furthermore, the evaluation should typically focus on effectiveness factors at this stage with less effort directed at the implementability and cost evaluation.

(3) Innovative and demonstrated technologies. Because of the limited data on innovative technologies, it may not be possible to evaluate these process options on the same basis as other demonstrated technologies. Typically, if innovative technologies are judged to be implementable they are retained for evaluation either as a "selected" process option (if available information indicates that they will provide better treatment, fewer or less adverse effects, or lower costs than other options), or they will be represented" by another process option of the same technology type. Tables 2-11 through 2-16 summarize available remedial action technologies for various contaminant migration pathways.

(4) Technology effectiveness evaluation.

(a) Specific technology processes that have been identified should be evaluated further on their effectiveness relative to other processes within the same technology type. This evaluation should focus on: the potential effectiveness of process options in handling the estimated areas or volumes of media and meeting the remediation goals identified in the remedial action objectives; the potential impacts to human health and the environment during the construction and implementation phase; and how proven and reliable the process is with respect to the contaminants and conditions at the site.

(b) Information needed to evaluate the effectiveness of technology types for the different media includes contaminant type and concentration, the area or volume of contaminated media, and rates of collection of liquid or gaseous media. It may be necessary to conduct preliminary analyses or collect additional site data to adequately evaluate effectiveness for processes in which the rates of removal or collection and treatment are needed for evaluation, such as for ground-water extraction, surface-water collection and treatment, or subsurface gas collection. In such cases, a limited conceptual design of the process may be developed, and modeling of the potential environmental transport mechanisms associated with their operation may be undertaken. Such analyses are conducted during the later phases of the FS when alternatives are being refined and evaluated on a sitewide basis.

(c) If modeling of transport processes is undertaken during the alternative development and screening phases of the FS to evaluate removal or collection technologies, and if many contaminants are present at the site indicator chemicals should be identified, as is often done for the baseline risk assessments, to simplify the analysis. Indicator chemicals are selected on the basis of their usefulness in evaluating potential effects on human health and the environment. Commonly selected indicator chemicals include those that are highly mobile and highly toxic.

(5) Technology implementability evaluation. Implementability encompasses both the technical and administrative feasibility of implementing a technology process. Technical implementability is used as an initial screen of technology types and process options to eliminate those that are clearly ineffective or unworkable at a site. Therefore, this subsequent, more detailed evaluation of process options places greater emphasis on the institutional aspects of implementability, such as the ability to obtain necessary permits for offsite actions, the availability of treatment, storage, and disposal services (including capacity), and the availability of necessary equipment and skilled workers to implement the technology.

(6) Technology cost evaluation. Cost plays a limited role in the screening of process options. Relative capital and operation and maintenance (O&N) costs are used rather than detailed estimates. At this stage in the process, the cost analysis is made on the basis of engineering judgment, and each process is evaluated as to whether costs are high, low, or medium relative to other process options in the same technology type. The greatest cost consequences in site remediation are usually associated with the degree to which different general technology types (i.e., containment, treatment, excavation, etc.) are used. Using different process options within a technology type usually has a less significant effect on cost than does the use of different technology types.

g. Assemble Alternatives.

(1) General response actions and the process options chosen to represent the various technology types for each medium or operable unit are combined to form alternatives for the site as a whole. Appropriate treatment

Table 2-11. Summary of Available Remedial Action Techniques for Contaminated Surface Flows

Technique	Functions	Applications/Restrictions
Surface sealing/capping	Isolates waste from contact with surface runoff and infiltration; stabilizes surface of site, controls offsite transport of contaminated sediments and debris; prevents surface leaks of leachate; supports revegetation	All land disposal sites; most effective when combined with grading and revegetation; requires suitable capping and cover materials
Grading	Shapes surface topography to provide for nonerosive runoff and minimize infiltration; supports revegetation	All land disposal sites; most effective when combined with surface sealing with revegetation; may require special landfill equipment
Revegetation	Stabilizes site surface; controls erosion by wind and water; controls off-site transport of contaminated debris; enhances surface sealing; may prepare site for future re-use	All land disposal sites; only recommended for properly sealed sites; may require irrigation in arid climates; most effective when combined with grading; may require special construction techniques and long-term maintenance
Surface water diversion and collection structures	Upslope or at perimeter of site, channels runoff around critical areas; downslope or onsite, controls off-site erosive transport of contaminated sediments; collects/channels contaminated runoff to basins/traps	All land disposal sites in sloping areas, surface impoundments; most suited for wet climates; often provides only short-term control for small drainage areas; associated maintenance costs; most effective when combined with grading and revegetation
Dikes and berms		
Ditches, diversions, and waterways		
Terraces and benches		
Chutes and downpipes		
Levees		

(Continued)

Table 2-11. (Concluded)

Technique	Functions	Applications/restrictions
Seepage basins	Collects surface runoff from diversion structures and provides for recharge to ground water	Wherever diversion structures have been implemented and where soil permeability is not too low to allow for recharge
Sedimentation basins/ traps	Collects and detains contaminated sediments eroded from disposal site surface; sediment-laden surface runoff intercepted and channeled to these structures; prevents contamination of local watercourses by disposal site	All land disposal sites with sediment erosion problems; must be located in fairly remote areas for large sediment pond construction; smaller sediment traps for basins only effective for small drainage areas
Check dams Sedimentation basins/ponds		
Leachate control	Controls offsite migration of surface leachate seeps (e.g., at base of fill) by collecting and treating or recirculating leachate	All disposal sites with surface seepage of leachate; particularly applicable to sites located on bedrock, where shallow ground water exists, or with impermeable sublayer
Collection Recirculation Treatment		
Treatment of contaminated surface waters	Removes contaminants by physical, chemical, and/or biological treatment methods	For contaminated surface runoff or natural watercourses that must be treated

Table 2-12. Summary of Available Remedial Action Techniques for Contaminated Ground Water

Technique	Functions	Applications/restrictions
Surface sealing	Indirectly controls ground-water contamination by reducing surface water infiltration (provides impermeable barrier), thereby minimizing leachate generation	All land disposal sites; most effective when combined with grading and revegetation; requires suitable capping and cover materials
Grading	Indirectly controls ground-water contamination by promoting surface runoff and reducing infiltration, thereby minimizing leachate generation	All land disposal sites; most effective when combined with surface sealing and revegetation; may require special landfill equipment
Revegetation	May be used to dry surface layers of filled refuse through root uptake/evapotranspiration, reducing volume of leachate generated, and thereby indirectly controlling ground-water contamination	This function of revegetation may be offset by enhanced detention and infiltration of surface runoff; site-tolerant species will be effective; may be effective at landfill sites with poorly drained surface layers and nonphyto-toxic wastes near the surface
Surface water diversion and collection structures Dikes and berms Ditches, diversions, and waterways Terraces and benches Chutes and downpipes	Upslope of sites may indirectly control ground-water contamination by intercepting and diverting surface runoff around site, reducing opportunity for runoff infiltration, and minimizing leachate generation	Structures must be upslope or at perimeter of disposal site to isolate site surface from contact with storm runoff; most suited for wet climates; often provide only short-term control for small drainage areas; associated maintenance costs; most effective when combined with grading and revegetation

(Continued)

Table 2-12. (Continued)

Technique	Functions	Applications/restrictions
Impermeable barriers	Upgradient from or around sites, diverts uncontaminated ground-water flow away from wastes; downslope or around sites contains/collects contaminated ground water to limit extent of aquifer pollution or protect offsite wells	All land disposal sites and surface impoundments with ground-water contamination; requires expensive preconstruction geotechnical evaluation, limited bedrock depths of less than 80 feet. Compatibility of wastes with grouts and, to a lesser extent, slurry walls has not been fully tested. Grouts not suitable for soils with low permeability
Permeable treatment beds	Adsorption, precipitation, or neutralization of certain ground-water contaminants downgradient of polluting disposal sites	Applicable to any land disposal site or surface impoundment with contaminated ground water flowing downgradient of site; carbon adsorption very costly; not a proven technique
Ground-water pumping	Lowers water table to prevent ground-water contact with buried or impounded wastes; lowers water table to prevent surface discharge of contaminated ground water; contains or collects a leachate plume for delivery to treatment system	Land disposal sites and surface impoundments that are contaminating local aquifers; particularly useful when dealing with permeable bedrock, where impermeable barriers cannot contain vertical migration

(Continued)

Table 2-12. (Concluded)

Technique	Functions	Applications/restrictions
Bioreclamation	Bacterial degradation/removal of petrochemical contaminants and other organics as ground water is recycled between pump stations	Not effective for ground-water contaminated by heavy metals, certain chlorinated organics, or other non-biodegradables; short-term treatment only; may be very costly; possibility of producing treatment residue more difficult to treat than original contaminant
Leachate control	Intercepts subsurface leachate before it migrates to ground water; collects and transports leachate to retreatment system or for recirculation	All disposal sites (landfills, surface impoundments) with subsurface leachate generation; limited applicability where soils are of low permeability; may not intercept all leachate if site is very large
Collection Recirculation Treatment		

Table 2-13. Summary of Available Remedial Action Techniques for Contaminated Air/Soil Pore Spaces

Technique	Functions	Applications/restrictions
Surface sealing	Horizontal sealing provides impermeable barrier to upward migration/surface escape of decomposition gases and volatiles	All land disposal sites; layered systems most effective for control of gas migration
Gas barriers	Vertical sealing prevents lateral movement; layered sealing systems may channel gases to vents and treatment structures	Vertical barriers should not be used alone for control of lateral migration; clay may crack in arid regions
Gas ventilation systems	Prevents lateral subsurface migration of gases; safely vents hazardous gases to the atmosphere or to treatment structures	Applicable as a remedial technique for control of volatile toxics or methane and decomposition gases at land disposal sites
Pipe vents Trench vents		
Gas collection and treatment	For control of volatile toxics, and malodorous decomposition gases, removal or destruction of pollutants by thermal oxidation or adsorption	All land disposal sites; generally cost-effective

Table 2-14. Summary of Available Remedial Action Techniques for Contaminated Soil and Sediments

Technique	Functions	Applications/restrictions
Surface sealing	Controls offsite transport of contaminated surface soil by capping waste site and stabilizing cover soil; prevents leachate seeps and subsequent contamination	All land disposal sites; most applicable to wet climates
Grading and revegetation	Controls offsite erosion of cover soil; binds soil particles, protects from wind and rain	All land disposal sites; most effective when combined with surface sealing; may be costly in arid climates
Surface water diversion and collection	Upslope of sites; diverts eroding runoff; downslope or on site surface, slows runoff, controls soil erosion, channels sediment-laden runoff to collection structures (traps/basins)	All land disposal sites; structures often temporary in nature; for small drainage areas; usually combined with revegetation and grading for long-term erosion control
Diversions Benches/terraces Sediment traps/basins	or stabilization outlets; traps and collects sediments	
Leachate control	Indirectly functions to prevent soil contamination by collecting and treating leachate that might otherwise migrate offsite	All land disposal sites and surface impoundments; effectiveness limited in poorly permeable soils
Disposal of dredged sediments	Safe disposal of contaminated sediments in secure landfill or by incineration	Only cost-effective for large volumes of dredged/excavated sediments

(Continued)

Table 2-14 (Concluded)

Technique	Functions	Applications/restrictions
Wet excavation techniques	Removes contaminated sediments from streams, rivers, and wetlands that may be ecologically fragile or important as public water sources	For contaminated sediments that have been eroded from the site and deposited in streambeds or wetlands; only cost-effective for removing large volumes of sediments; mechanical excavation is most cost-effective for small, low flow streams; may not be feasible for very remote, inaccessible sites
Stream diversion		
Mechanical excavation		
Hydraulic dredging		
Dewatering		

Table 2-15. Summary of Available Remedial Action Techniques for Hazardous Wastes

Technique	Functions	Applications/restrictions
Mechanical excavation	Removes waste materials from site for treatment or secured disposal by power shovel, clamshell, etc.	Landfills, small surface impoundments with high-solids waste material
Hydraulic dredging	Pumps waste materials to treatment, or for transportation to secured disposal	Surface impoundments with pumpable solids
Land disposal	Disposes of waste materials in impoundments, landfills, and landforms	Most widely used method for waste disposal; improper disposal can result in air pollution, ground-water and surface-water contamination; RCRA requirements will markedly increase the cost but will provide for more sound disposal methods
Incineration	Thermally oxidizes waste material in controlled environment	Most effective for all organic wastes, especially those with low flash points containing relatively low ash contents. Applicable to wastes that are oxidizable at temperatures below 2500°F
Wet-air oxidation	Oxidizes waste material by low-temperature thermal air	Most economical for wastes with high COD; may be used in conjunction with biological treatment
Solidification	Incorporates waste material into immobile matrix such as cement or resin	Most economical for small quantities of waste. Waste material must be compatible with solidification agent. Not well demonstrated for nonradioactive wastes; may leach from some matrices over time

(Continued)

Table 2-15. (Concluded)

Technique	Functions	Applications/restrictions
Encapsulation	Surrounds waste material with impermeable coating	Most applicable to containerized waste materials or dewatered sludges; not fully demonstrated; costly
Solution mining technical	Treats the waste in-place by mobilizing contaminants or flushing them through to ground water, and collecting	Most applicable to surface impoundments; may eliminate need for hazardous excavation; best suited for flushing heavy metals and basic organics; difficult to determine extent to which solution makes contact with wastes; generally used with ground-water pumping or leachate collection; not well demonstrated
In-situ solidification	Injects waste solidification agents directly into waste site	Applicable to liquid wastes from surface impoundments, well-defined landfill sections. Not applicable to containerized wastes
In-situ neutralization/detoxification	Neutralizes or immobilizes wastes by application of a neutralization agent such as lime to the waste material	Most applicable to surface impoundments, disposal sites with permeable surfaces; metal-bearing wastes. Degree of effectiveness difficult to determine
Microbial seeding	Biodegrades organic wastes	Most effective for landforms and surface impoundments; can degrade a wide range of organics when acclimated; degradation process can be slow depending on acclimation and adequate aeration

Table 2-16. Summary of Available Remedial Action Techniques for Contaminated Water and Sewer Lines

Technique	Functions	Applications/restrictions
In-situ cleaning	Cleans interiors of municipal sewer and water pipelines infiltrated by contaminated sediments or ground water; removes infiltrated contaminants	Most applicable to contaminated gravity sewer lines; most techniques well established and cost-effective
Scouring		
Flushing		
Dredging		
Suction cleaning		
Leak detection and repair	Allows discovery and repair of leaks, cracks, etc. (points of infiltration/exfiltration)	Most applicable to contaminated sewer lines; techniques well established and generally cost-effective
Pipeline inspection		
Grouting		
Relining		
Pipeline removal and replacement	Replaces badly damaged sewer lines or contaminated water mains	May be only option feasible for contaminated public water mains; very costly for deep pipelines

and containment options should be developed. To assemble alternatives, general response actions should be combined using different technology types and different volumes of media and/or areas of the site. Often more than one general response action is applied to each medium. For example, alternatives for remediating soil contamination will depend on the type and distribution of contaminants and may include incineration of soil from some portions of the site and capping of others.

(2) Alternatives should be developed that will provide decisionmakers with an appropriate range of options and sufficient information to adequately compare alternatives. In developing alternatives, the range of options will vary depending on site-specific conditions. Ranges for source control and ground-water response actions that should be developed are described below.

(3) For source control actions, the following types of alternatives should be developed to the extent practicable:

(a) A number of treatment alternatives, ranging from one that would eliminate or minimize to the extent feasible the need for long-term management (including monitoring) at a site to one that would use treatment as a primary component of an alternative to address the principal threats at the site. Alternatives for which treatment is a principal element could include containment elements for untreated waste or treatment residuals as well. Alternatives within this range typically will differ in the type and extent of treatment used and the management requirements of treatment residuals or untreated wastes.

(b) One or more alternatives that involve containment of waste with little or no treatment but protect human health and the environment by preventing potential exposure and/or reducing the mobility of contaminants.

(c) No-action alternatives. (Although a no-action alternative may include some type of environmental monitoring, actions taken to reduce the potential for exposure (e.g., site fencing, deed restrictions) should not be included as a component of the no-action alternatives. Such minimal actions should constitute a separate "limited" action alternative.)

(4) For ground-water response actions, alternatives should address not only cleanup levels but also the timeframe within which the alternatives might be achieved. Depending on specific site conditions and the aquifer characteristics, alternatives should be developed that achieve ARARs or other health-based levels determined to be protective within varying timeframes using different methodologies. For aquifers currently being used as a drinking water source, alternatives should be configured that would achieve ARARs or risk-based levels as rapidly as possible. More detailed information on developing remedial alternatives for ground-water response actions may be found in "Guidance on Remedial Actions for Contaminated Ground Water at Superfund Sites" (EPA, August 1988).

(5) Development of a complete range of treatment alternatives will not be practical in some situations. For example, for sites with large volumes of low contamination wastes such as some municipal landfills and mining sites, an alternative that eliminates the need for long-term management may not be reasonable given site conditions, the limitations of technologies, and extreme costs that may be involved. If a full range of alternatives is not developed, the specific reasons for doing so should be briefly discussed in the FS report to serve as documentation that treatment alternatives were assessed as required by CERCLA.

2-19. Alternative Screening Evaluation.

a. General Concept.

(1) For those situations in which numerous waste management options are appropriate and developed, the assembled alternatives may need to be refined and screened to reduce the number of alternatives that will be analyzed in detail. This screening aids in streamlining the FS process while ensuring that the most promising alternatives are being considered.

(2) In other situations the number of viable or appropriate alternatives for addressing site problems may be limited; thus, the screening effort may be minimized or eliminated if unnecessary. The scope of this screening effort can vary substantially, depending on the number and type of alternatives developed and the extent of information necessary for conducting the detailed analysis. The scope and emphasis can also vary depending on either the degree to which the assembled alternatives address the combined threats posed by the entire site or on the individual threats posed by separate site areas or contaminated media. Whatever the scope, the range of treatment and containment alternatives initially developed should be preserved through the alternative screening process to the extent that it makes sense to do so.

(3) As part of the screening process, alternatives are analyzed to investigate interactions among media in terms of both the evaluation of technologies (i.e., the extent to which source control influences the degree of ground-water or air-quality control) and sitewide protectiveness (i.e. whether the alternative provides sufficient reduction of risk from each media and/or pathway of concern for the site or that part of the site being addressed by an operable unit). Also at this stage, the areas and quantities of contaminated media initially specified in the general response actions may also be reevaluated with respect to the effects of interactions between media. Often, source control actions influence the degree to which ground-water remediation can be accomplished or the timeframe in which it can be achieved. In such instances, further analyses may be conducted to modify either the source control or ground-water response actions to achieve greater effectiveness in sitewide alternatives. Using these refined alternative configurations, more detailed information about the technology process options

may be developed. This information might include data on the size and capacities of treatment systems, the quantity of materials required for construction, and the configuration and design requirements for ground-water collection systems.

(4) Information available at the time of screening should be used primarily to identify and distinguish any differences among the various alternatives and to evaluate each alternative with respect to its effectiveness, implementability, and cost. Only the alternatives judged as the best or most promising on the basis of these evaluation factors should be retained for further consideration and analysis. As with the use of representative technologies, alternatives may be selected to represent sufficiently similar management strategies; thus, in effect, a separate analysis for each alternative is not always warranted. Typically, those alternatives that are screened out will receive no further consideration unless additional information becomes available that indicates further evaluation is warranted. For sites at which interactions among media are not significant, the process of screening alternatives, described here, may be applied to medium-specific options to reduce the number of options that will either be combined into sitewide alternatives at the conclusion of screening or will await further evaluation in the detailed analyses.

b. Alternative Screening Criteria.

(1) Defined alternatives are evaluated against the short- and long-term aspects of three broad criteria: effectiveness, implementability, and cost. Because the purpose of the screening evaluation is to reduce the number of alternatives that will undergo a more thorough and extensive analysis, alternatives will be evaluated more generally in this phase than during the detailed analysis. However, evaluations at this time should be sufficiently detailed to distinguish among alternatives. In addition, the alternatives must be compared on an equivalent basis (i.e., definitions of alternatives are approximately at the same level of detail to allow preparation of comparable cost estimates).

(2) Initially, specific technologies or process options were evaluated primarily on the basis of whether or not they could meet a particular remedial action objective. During alternative screening, the entire alternative is evaluated as to its effectiveness, implementability, and cost.

(3) During the detailed analysis, the alternatives will be evaluated against nine specific criteria and their individual factors rather than the general criteria used in screening. Therefore, individuals conducting the FS should be familiar with the nine criteria at the time of screening to better understand the direction that the analysis will be taking. The relationship between the screening criteria and the nine evaluation criteria is conceptually illustrated in Figure 2-13.

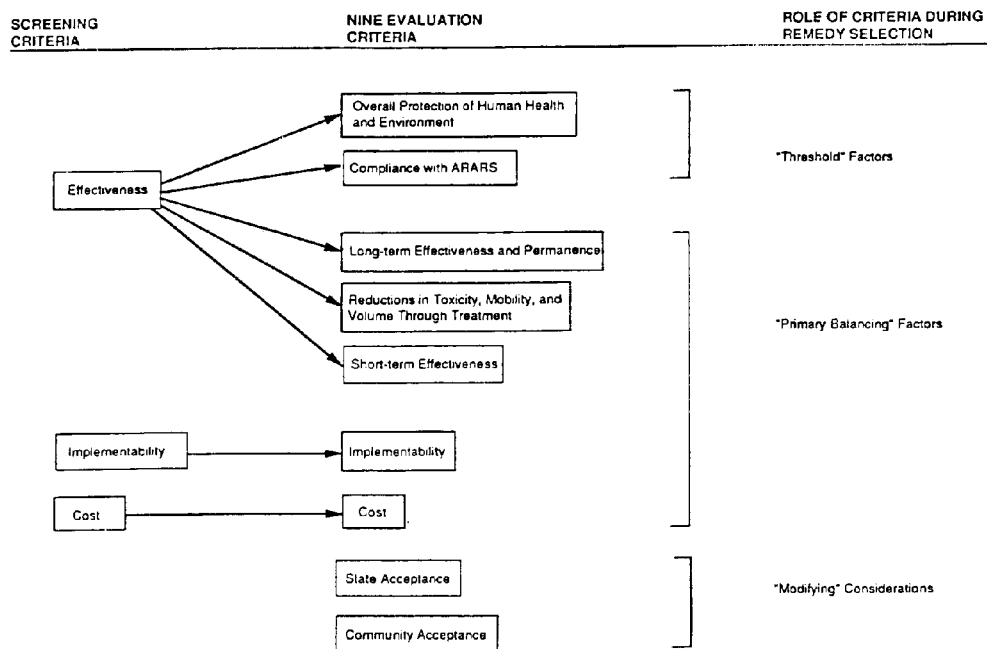

Figure 2-13. Relationship Between Screening Criteria and Detailed Evaluation

(4) It is also important to note that comparisons during screening are usually made between similar alternatives (the most promising of which is carried forward for further analysis); whereas, comparisons during the detailed analysis will differentiate across the entire range of alternatives.

c. Effectiveness Evaluation. A key aspect of the screening evaluation is the effectiveness of each alternative in protecting human health and the environment. Each alternativeshould be evaluated as to its effectiveness in providing protection and the reductions in toxicity, mobility, or volume that it will achieve. Both short- and long-term components of effectiveness should be evaluated; short-term referring to the construction and implementation period, and long-term referring to the period after the remedial action is complete. Reduction of toxicity, mobility, or volume refers to changes in one or more characteristics of the hazardous substances or contaminated media by the use of treatment that decreases the inherent threats or risks associated with the hazardous material.

d. Alternative Implementability Evaluation.

(1) Implementability, as a measure of both the technical and administrative feasibility of constructing, operating, and maintaining a remedial action alternative, will be used during screening to evaluate the

combinations of process options with respect to conditions at a specific site. Technical feasibility refers to the ability to construct, reliably operate, and meet technology-specific regulations for process options until a remedial action is complete; it also includes operation, maintenance, replacement, and monitoring of technical components of an alternative, if required, into the future after the remedial action is complete. Administrative feasibility refers to the ability to obtain approvals from other offices and agencies, the availability of treatment, storage, and disposal services and capacity, and the requirements for, and availability of, specific equipment and technical specialists.

(2) The determination that an alternative is not technically feasible and is not available will usually preclude it from further consideration unless steps can be taken to change the conditions responsible for the determination. Typically, this type of "fatal flaw" would have been identified during technology screening, and the infeasible alternative would not have been assembled. Negative factors affecting administrative feasibility will normally involve coordination steps to lessen the negative aspects of the alternative but will not necessarily eliminate an alternative from consideration.

e. Alternative Cost Evaluation.

(1) Typically, alternatives will have been defined well enough before screening that some estimates of cost are available for comparisons among alternatives. However, because uncertainties associated with the definition of alternatives often remain, it may not be practicable to define the costs of alternatives with the accuracy desired for the detailed analysis (i.e., +50 percent to -30 percent).

(2) Absolute accuracy of cost estimates during screening is not essential. The focus should be to make comparative estimates for alternatives with relative accuracy so that cost decisions among alternatives will be sustained as the accuracy of cost estimates improves beyond the screening process. The procedures used to develop cost estimates for alternative screening are similar to those used for the detailed analysis; the only differences would be in the degree of alternative refinement and in the degree to which cost components are developed.

(3) Cost estimates for screening alternatives typically will be based on a variety of cost-estimating data. Bases for screening cost estimates may include cost curves, generic unit costs, vendor information, conventional cost-estimating guides, and prior similar estimates as modified by site-specific information.

(4) Prior estimates, site-cost experience, and good engineering judgments are needed to identify those unique items in each alternative that will control these comparative estimates. Cost estimates for items common to all alternatives or indirect costs (engineering, financial, supervision, outside contractor support, contingencies) do not normally warrant substantial effort during the alternative screening phase.

(5) Both capital and O&M costs should be considered during the screening of alternatives. The evaluation should include those O&M costs that will be incurred for as long as necessary, even after the initial remedial action is complete. In addition, potential future remedial action costs should be considered during alternative screening to the extent they can be defined. Present worth analyses should be used during alternative screening to evaluate expenditures that occur over different time periods. By discounting all costs to a common base year, the costs for different remedial action alternatives can be compared on the basis of a single figure for each alternative.

f. Innovative Technologies.

(1) Technologies are classified as innovative if they are developed fully but lack sufficient cost or performance data for routine use at Superfund sites. In many cases, it will not be possible to evaluate alternatives incorporating innovative technologies on the same basis as available technologies, because insufficient data exist on innovative technologies. If treatability testing is being considered to better evaluate an innovative technology, the decision to conduct a test should be made as early in the process as possible to avoid delays in the RI/FS schedule.

(2) Innovative technologies would normally be carried through the screening phase if there were reason to believe that the innovative technology would offer significant advantages. These advantages may be in the form of better treatment performance or implementability, fewer adverse impacts than other available approaches, or lower costs for similar levels of performance. A "reasonable belief" exists if indications from other full-scale applications under similar circumstances or from bench-scale or pilot-scale treatability testing support the expected advantages.

2-20. Alternative Screening.

a. Guidelines for Screening.

(1) Alternatives with the most favorable composite evaluation of all factors should be retained for further consideration during the detailed analysis. Alternatives selected for further evaluation should, where practicable, preserve the range of treatment and containment technologies initially developed. It is not a requirement that the entire range of alternatives originally developed be preserved if all alternatives in a portion of the range do not represent distinct viable options.

(2) The target number of alternatives to be carried through screening should be set by the project manager and the lead agency on a site-specific basis. It is expected that the typical target number of alternatives carried through screening (including containment and no-action alternatives) usually should not exceed 10. Fewer alternatives should be carried through screening, if possible, while adequately preserving the range of remedies. If the alternatives being screened are still medium-specific and do not address the entire site or operable unit, the number of alternatives retained for each specific medium should be considerably less than 10.

b. Selection of Alternatives for Detailed Analysis.

(1) Once the evaluation has been conducted for each of the alternatives, the lead agency and its contractor should meet with the support agency to discuss each of the alternatives being considered. This meeting does not correspond to a formal quality control review stage but provides the lead agency and its contractor with input from the support agency and serves as a forum for updating the support agency with the current direction of the FS.

(2) The alternatives recommended for further consideration should be agreed upon at this meeting so that documentation of the results of alternative screening is complete; any additional investigations that may be necessary are identified; and the detailed analysis can commence.

(3) Unselected alternatives may be reconsidered at a later step in the detailed analysis if similar retained alternatives continue to be evaluated favorably or if information is developed that identifies an additional advantage not previously apparent. This provides the flexibility to double check a previous decision or to review variations of alternatives being considered (e.g., consideration of other similar process options). However, it is expected that under most circumstances once an alternative is screened out it will not be reconsidered for selection.

c. Postscreening Tasks. The completion of the screening process leads directly into the detailed analysis and may serve to identify additional investigations that may be needed to adequately evaluate alternatives. To ensure a smooth transition from the screening of alternatives to the detailed analysis, it will be necessary to identify and begin verifying action-specific ARARs and initiate treatability testing (if not done previously) and additional site characterization.

2-21. Treatability Investigations. As site information is collected during the RI and alternatives are being developed, additional data needs necessary to adequately evaluate alternatives during the detailed analysis are often identified. These additional data needs may involve the collection of site characterization data or treatability studies to better evaluate technology performance.

a. Objectives. Treatability studies are conducted primarily to achieve the following:

(1) Provide sufficient data to allow treatment alternatives to be fully developed and evaluated during the detailed analysis and to support the remedial design of a selected alternative.

(2) Reduce cost and performance uncertainties for treatment alternatives to acceptable levels so that a remedy can be selected.

b. Bench Versus Pilot Testing.

(1) Alternatives involving treatment or destruction technologies may require some form of treatability testing, if their use represents first-of-its-kind applications on unique or heterogeneous wastes.

(2) Once a decision is made to perform treatability studies, the RI/FS contractor and lead agency remedial project manager will decide on the type of treatability testing to use. This decision must always be made taking into account the technologies under consideration, performance goals, and site characteristics.

(3) The choice of bench versus pilot testing is affected by the level of development of the technology. For a technology that is well developed and tested, bench studies are often sufficient to evaluate performance on new wastes. For innovative technologies, however, pilot tests may be required since information necessary to conduct full-scale tests is either limited or nonexistent. A comparison of bench- and pilot-scale studies appears in Table 2-17.

Table 2-17. Bench and Pilot Study Parameters

<u>Parameter</u>	<u>Bench</u>	<u>Pilot</u>
Purpose	Define process kinetics, material compatibility, impact of environmental factors, types of doses of chemicals, active mechanisms, etc.	Define design and operation criteria, materials of construction, ease of material handling and construction, etc.
Size	Laboratory or bench top	1-100% of full scale
Quantity of waste and materials required	Small to moderate amounts	Relatively large amounts
Number of variables that can be considered	Many	Few (greater site-specificity)
Time requirements	Days to weeks	Weeks to months
Typical cost range	0.5-2% of capital costs of remedial action	2-5% of capital costs of remedial action ¹
Most frequent location	Laboratory	Onsite
Limiting considerations	Wall, boundary, and mixing effects; volume effects; solids processing difficult to simulate; transportation of sufficient waste volume	Limited number of variables; large waste volume required; safety, health, and other risks; disposal of process waste material

¹ Actual percentage cost of pilot testing will depend significantly on the total cost of the remedial action.

c. Treatability Test Work Plan. Laboratory testing can be expensive and time consuming. A well-written work plan is necessary if a treatability testing program is to be completed on time, within budget, and with accurate results. Preparation of a work plan provides an opportunity to run the test mentally and review comments before starting the test. It also reduces the ambiguity of communication between the lead agency*s remedial project manager (RPM), the contractor*s project manager, the technician performing the test, and the laboratory technician performing the analyses on test samples. The treatability test work plan may be an amendment to the original work plan if the need for the treatability tests was not identified until later in the process or may be a separate plan specifically for this phase. Regardless, the work plan should be reviewed and approved by the lead agency*s RPM. The RPM and RI/FS contractor should determine the appropriate level of detail for the work plan since a detailed plan is not always needed and will require time to prepare and approve. In some situations the original work plan may adequately describe the treatability tests and a separate plan is not required (e.g., the need for treatability testing can be identified during the scoping phase if existing information is sufficient).

Section V. Detailed Analysis of Alternatives

2-22. Background.

a. The detailed analysis of alternatives consists of the analysis and presentation of the relevant information needed to allow decisionmakers to select a site remedy, not the decision making process itself. During the detailed analysis, each alternative will be assessed against the evaluation criteria described in this chapter. The results of this assessment should be arrayed to compare the alternatives and identify the key tradeoffs among them. This approach to analyzing alternatives is designed to provide decisionmakers with sufficient information to adequately compare the alternatives, select an appropriate remedy for a site, and demonstrate satisfaction of the CERCLA remedy selection requirements in the record of decision (ROD). A detailed analysis of alternatives consists of the following components:

(1) Further definition of each alternative, if necessary, with respect to the volumes or areas of contaminated media to be addressed, the technologies to be used, and any performance requirements associated with those technologies.

(2) An assessment and a summary profile of each alternative against the evaluation criteria.

(3) A comparative analysis among the alternatives to assess the relative performance of each alternative with respect to each evaluation criterion.

b. The specific statutory requirements for remedial actions that must be addressed in the ROD and supported by the FS report are:

- (1) They are protective of human health and the environment,
- (2) They attain ARARs (or provide grounds for invoking a waiver),
- (3) They are cost-effective,
- (4) They utilize permanent solutions and alternative treatment technologies or resource recovery technologies to the maximum extent practicable, and
- (5) They satisfy the preference for treatment that reduces toxicity, mobility, or volume as a principal element or provide an explanation in the ROD as to why the alternative does not.

c. In addition, CERCLA places an emphasis on evaluating long-term effectiveness and related considerations for each of the alternative remedial actions (Section 121(b)(1)(A)). These statutory considerations include:

- (1) The long-term uncertainties associated with land disposal;
- (2) The goals, objectives, and requirements of the Solid Waste Disposal Act (PL 96-463);
- (3) The persistence, toxicity, and mobility of hazardous substances and their constituents, and their propensity to bioaccumulate;
- (4) Short- and long-term potential for adverse health effects from human exposure;
- (5) Long-term maintenance costs;
- (6) The potential for future remedial action costs if the alternative remedial action in question were to fail; and
- (7) The potential threat to human health and the environment associated with excavation, transportation, and redisposal, or containment.

2-23. Overview of Evaluation Criteria.

a. Nine evaluation criteria have been developed to address the CERCLA requirements and considerations listed above, and to address the additional technical and policy considerations that have proven to be important for selecting among remedial alternatives. These evaluation criteria serve as the basis for conducting the detailed analyses during the FS and for subsequently selecting an appropriate remedial action. The evaluation criteria with the associated CERCLA statutory considerations are:

- (1) Overall protection of human health and the environment.
- (2) Compliance with ARARs (B).

- (3) Long-term effectiveness and permanence (A,B,C,D,F,G).
- (4) Reduction of toxicity, mobility, or volume (B,C).
- (5) Short-term effectiveness (D,G).
- (6) Implementability.
- (7) Cost (E,F).
- (8) State acceptance (relates to Section 121(f)).
- (9) Community acceptance (relates to Sections 113 and 117).

b. The detailed analysis provides the means by which facts are assembled and evaluated to develop the rationale for a remedy selection. Therefore, it is necessary to understand the requirements of the remedy selection process to ensure that the FS analysis provides the sufficient quantity and quality of information to simplify the transition between the FS report and the actual selection of a remedy. The analytical process described here has been developed on the basis of statutory requirements of CERCLA Section 121. The nine evaluation criteria encompass statutory requirements and technical, cost, and institutional considerations the program has determined appropriate for a thorough evaluation.

c. Assessments against two of the criteria relate directly to statutory findings that must ultimately be made in the ROD. Therefore, these are categorized as threshold criteria in that each alternative must meet them. These two criteria are:

(1) Overall protection of human health and the environment - The assessment against this criterion describes how the alternative, as a whole, achieves and maintains protection of human health and the environment.

(2) Compliance with ARARs - The assessment against this criterion describes how the alternative complies with ARARs, or if a waiver is required and how it is justified. The assessment also addresses other information from advisories, criteria, and guidance that the lead and support agencies have agreed is "to be considered."

d. The five criteria listed below are grouped because they represent the primary criteria upon which the analysis is based. The level of detail required to analyze each alternative against these evaluation criteria will depend on the type and complexity of the site, the type of technologies and alternatives being considered, and other project-specific considerations. The analysis should be conducted in sufficient detail so that decisionmakers understand the significant aspects of each alternative and any uncertainties associated with the evaluation (e.g., a cost estimate developed on the basis of a volume of media that could not be defined precisely).

(1) Long-term effectiveness and permanence - The assessment of alternatives against this criterion evaluates the long-term effectiveness of alternatives in maintaining protection of human health and the environment after response objectives have been met.

(2) Reduction of toxicity, mobility, and volume through treatment - The assessment against this criterion evaluates the anticipated performance of the specific treatment technologies an alternative may employ.

(3) Short-term effectiveness - The assessment against this criterion examines the effectiveness of alternatives in protecting human health and the environment during the construction and implementation of a remedy until response objectives have been met.

(4) Implementability - This assessment evaluates the technical and administrative feasibility of alternatives and the availability of required goods and services.

(5) Cost - This assessment evaluates the capital and O&M costs of each alternative.

e. The final two criteria, state or support agency acceptance and community acceptance, will be evaluated following comment on the RI/FS report and the proposed plan and will be addressed once a final decision is being made and the ROD is being prepared. The criteria are as follows:

(1) State (support agency) acceptance - This assessment reflects the state*s (or support agency*s) apparent preferences among or concerns about alternatives.

(2) Community acceptance - This assessment reflects the community*s apparent preferences among or concerns about alternatives.

2-24. Discussion of Evaluation Factors. Each of the nine evaluation criteria has been further divided into specific factors to allow a thorough analysis of the alternatives. These factors are shown in Figure 2-14 and discussed below:

a. Overall Protection of Human Health and the Environment. This evaluation criterion provides a final check to assess whether each alternative provides adequate protection of human health and the environment. The overall assessment of protection draws on the assessments conducted under other evaluation criteria, especially long-term effectiveness and permanence, short-term effectiveness, and compliance with ARARs. Evaluation of the overall protectiveness of an alternative during the RI/FS should focus on whether a specific alternative achieves adequate protection and should describe how site risks posed through each pathway being addressed by the FS are eliminated, reduced, or controlled through treatment, engineering, or institutional controls. This evaluation also allows for consideration of whether an alternative poses any unacceptable short-term or cross-media impacts.

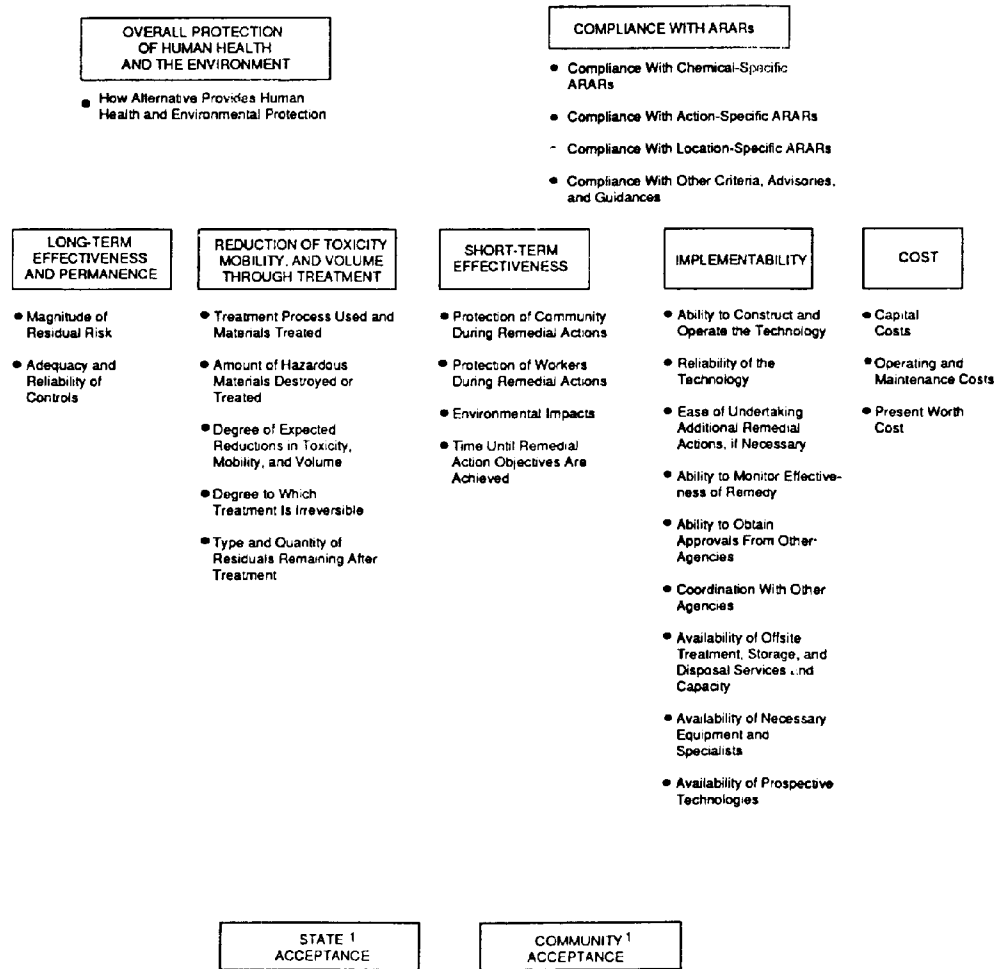

¹ These criteria are assessed following comment on the R/VFS report and the proposed plan.

Figure 2-14. Detailed Analysis of Alternatives

b. Compliance with ARARs. This evaluation criterion is used to determine whether each alternative will meet all of its Federal and state ARARs (as defined in CERCLA Section 121) that have been identified in previous stages of the RI/FS process. The detailed analysis should summarize which requirements are applicable or relevant and appropriate to an alternative and describe how the alternative meets these requirements. When an ARAR is not met, the basis for justifying one of the six waivers allowed under CERCLA should be discussed. The actual determination of which requirements are applicable or relevant and appropriate is made by the lead agency in consultation with the support agency. A summary of these ARARs and whether they will be attained by a specific alternative should be presented in an appendix to the RI/FS report. Detailed guidance on determining whether requirements are applicable or relevant and appropriate is provided in the "CERCLA Compliance with Other Laws Manual" (U.S. EPA, Draft, May 1988). The following should be addressed for each alternative during the detailed analysis of ARARs:

(1) Compliance with chemical-specific ARARs (e.g., maximum contaminant levels) - This factor addresses whether the ARARs can be met, and if not, whether a waiver is appropriate.

(2) Compliance with location-specific ARARs (e.g., preservation of historic sites) - As with other ARAR-related factors, this involves a consideration of whether the ARARs can be met or whether a waiver is appropriate.

(3) Compliance with action-specific ARARs (e.g., RCRA minimum technology standards) - It must be determined whether ARARs can be met or will be waived.

(4) Other available information that is not an ARAR (e.g., advisories, criteria, and guidance) may be considered in the analysis if it helps to ensure protectiveness or is otherwise appropriate for use in a specific alternative. These materials should be included in the detailed analysis if the lead and support agencies agree that their inclusion is appropriate.

c. Long-term Effectiveness and Permanence. The evaluation of alternatives under this criterion addresses the results of a remedial action in terms of the risk remaining at the site after response objectives have been met. The primary focus of this evaluation is the extent and effectiveness of the controls that may be required to manage the risk posed by treatment residuals and/or untreated wastes. Table 2-18 lists appropriate questions that may need to be addressed during the analysis of long-term effectiveness. The following components of the criterion should be addressed for each alternative:

(1) Magnitude of residual risk - This factor assesses the residual risk remaining from untreated waste or treatment residuals at the conclusion of remedial activities (e.g., after source/soil containment and/or treatment are complete, or after ground-water plume management activities are concluded).

Table 2-18. Long-Term Effectiveness and Permanence

Analysis factor	Specific factor considerations
Magnitude of residual risks	<ul style="list-style-type: none"> ! What is the magnitude of the remaining risks? ! What remaining sources of risk can be identified? How much is due to treatment residuals, and how much is due to untreated residual contamination? ! Will a 5-year review be required?
Adequacy and reliability of controls	<ul style="list-style-type: none"> ! What is the likelihood that the technologies will meet required process efficiencies or performance specifications? ! What type and degree of long-term management is required? ! What are the requirements for long-term monitoring? ! What operation and maintenance functions must be performed? ! What difficulties and uncertainties may be associated with long-term operation and maintenance? ! What is the potential need for replacement of technical components? ! What is the magnitude of the threats or risks should the remedial action need replacement? ! What is the degree of confidence that controls can adequately handle potential problems? ! What are the uncertainties associated with land disposal of residuals and untreated wastes?

The potential for this risk may be measured by numerical standards such as cancer risk levels or the volume or concentration of contaminants in waste, media, or treatment residuals remaining on the site. The characteristics of the residuals should be considered to the degree that they remain hazardous, taking into account their volume, toxicity, mobility, and propensity to bioaccumulate.

(2) Adequacy and reliability of controls - This factor assesses the adequacy and suitability of controls, if any, that are used to manage treatment residuals or untreated wastes that remain at the site. It may include an assessment of containment systems and institutional controls to determine if they are sufficient to ensure that any exposure to human and environmental receptors is within protective levels. This factor also addresses the long-term reliability of management controls for providing continued protection from residuals. It includes the assessment of the potential need to replace technical components of the alternative, such as a cap, a slurry wall, or a treatment system, and the potential exposure pathway and the risks posed should the remedial action need replacement.

d. Reduction of Toxicity, Mobility, or Volume through Treatment. This evaluation criterion addresses the statutory preference for selecting remedial

actions that employ treatment technologies that permanently and significantly reduce toxicity, mobility, or volume of the hazardous substances as their principal element. This preference is satisfied when treatment is used to reduce the principal threats at a site through destruction of toxic contaminants, reduction of the total mass of toxic contaminants, irreversible reduction in contaminant mobility, or reduction of total volume of contaminated media. In evaluating this criterion, an assessment should be made as to whether treatment is used to reduce principal threats, including the extent to which toxicity, mobility, or volume are reduced either alone or in combination. Table 2-19 lists typical questions that may need to be addressed during the analysis of toxicity, mobility, or volume reduction.

Table 2-19. Reduction of Toxicity, Mobility, or Volume through Treatment

Analysis factor	Specific factor considerations
Treatment process and remedy	<ul style="list-style-type: none"> ! Does the treatment process employed address the principal threats? ! Are there any special requirements for the treatment process?
Amount of hazardous material destroyed or treated	<ul style="list-style-type: none"> ! What portion (mass, volume) of contaminated material is destroyed? ! What portion (mass, volume) of contaminated material is treated?
Reduction in toxicity, mobility, or volume	<ul style="list-style-type: none"> ! To what extent is the total mass of toxic contaminants reduced? ! To what extent is the mobility of toxic contaminants reduced? ! To what extent is the volume of toxic contaminants reduced?
Irreversibility of the treatment	<ul style="list-style-type: none"> ! To what extent are the effects of treatment irreversible?
Type and quantity of treatment residual	<ul style="list-style-type: none"> ! What residuals remain? ! What are their quantities and characteristics? ! What risks do treatment residuals pose?
Statutory preference for treatment as a principal element	<ul style="list-style-type: none"> ! Are principal threats within the scope of the action? ! Is treatment used to reduce inherent hazards posed by principal threats at the site?

e. Short-term Effectiveness. This criterion addresses the effects of the alternative during the construction and implementation phase until remedial response objectives are met (e.g., a cleanup target has been met). Under this criterion, alternatives should be evaluated with respect to their effects on human health and the environment during implementation of the

remedial action. The following factors should be addressed as appropriate for each alternative:

(1) Protection of the community during remedial actions - This aspect of short-term effectiveness addresses any risk that results from implementation of the proposed remedial action, such as dust from excavation, transportation of hazardous materials, or air-quality impacts from a stripping tower operation that may affect human health.

(2) Protection of workers during remedial actions - This factor assesses threats that may be posed to workers and the effectiveness and reliability of protective measures that would be taken.

(3) Environmental impacts - This factor addresses the potential adverse environmental impacts that may result from the construction and implementation of an alternative and evaluates the reliability of the available mitigation measures in preventing or reducing the potential impacts.

(4) Time until remedial response objectives are achieved - This factor includes an estimate of the time required to achieve protection for either the entire site or individual elements associated with specific site areas or threats.

(5) Table 2-20 lists appropriate questions that may need to be addressed during the analysis of short-term effectiveness.

f. Implementability. This criterion addresses the technical and administrative feasibility of implementing an alternative and the availability of various services and materials required during its implementation. Table 2-21 lists typical questions that may need to be addressed during the analysis of implementability. This criterion involves analysis of the following factors:

(1) Technical feasibility.

(a) Construction and operation - This relates to the technical difficulties and unknowns associated with a technology. This was initially identified for specific technologies during the development and screening of alternatives and is addressed again in the detailed analysis for the alternative as a whole.

(b) Reliability of technology - This focuses on the likelihood that technical problems associated with implementation will lead to schedule delays.

(c) Ease of undertaking additional remedial action - This includes a discussion of what, if any, future remedial actions may need to be undertaken and how difficult it would be to implement such additional actions. This is particularly applicable for an FS addressing an interim action at a site where additional operable units may be analyzed at a later time.

Table 2-20. Short-Term Effectiveness

<u>Analysis factor</u>	<u>Basis for evaluation during detailed analysis</u>
Protection of community during remedial actions	! What are the risks to the community during remedial actions that must be addressed? ! How will the risks to the community be addressed and mitigated? ! What risks remain to the community that cannot be readily controlled?
Protection of workers during remedial actions	! What are the risks to the workers that must be addressed? ! What risks remain to the workers that cannot be readily controlled? ! How will the risks to the workers be addressed and mitigated?
Environmental impacts	! What environmental impacts are expected with the construction and implementation of the alternative? ! What are the available mitigation measures to be used and what is their reliability to minimize potential impacts? ! What are the impacts that cannot be avoided should the alternative be implemented?
Time until remedial response objectives are achieved	! How long until protection against the threats being addressed by the specific action is achieved? ! How long until any remaining site threats will be addressed? ! How long until remedial response objectives are achieved?

(d) Monitoring consideration - This addresses the ability to monitor the effectiveness of the remedy and includes an evaluation of the risks of exposure should monitoring be insufficient to detect a system failure.

(2) Administrative feasibility.

(a) Activities needed to coordinate with other offices and agencies (e.g., obtaining permits for offsite activities or rights-of-way for construction).

(b) Availability of services and materials.

(c) Availability of adequate offsite treatment, storage capacity, and disposal services.

Table 2-21. Implementability

<u>Analysis factor</u>	<u>Specific factor considerations</u>
	<u>Technical Feasibility</u>
Ability to construct and operate technology	! What difficulties may be associated with construction? ! What uncertainties are related to construction?
Reliability of technology	! What is the likelihood that technical problems will lead to schedule delays?
Ease of undertaking additional remedial action, if necessary	! What likely future remedial actions may be anticipated? ! How difficult would it be to implement the additional remedial actions, if required?
Monitoring considerations	! Do migration or exposure pathways exist that cannot be monitored adequately? ! What risks of exposure exist should monitoring be insufficient to detect failure?
	<u>Administrative Feasibility</u>
Coordination with other agencies	! What steps are required to coordinate with other agencies? ! What steps are required to set up long-term or future coordination among agencies? ! Can permits for offsite activities be obtained if required?
	<u>Availability of Services and Materials</u>
Availability of treatment, storage capacity, and disposal services	! Are adequate treatment, storage capacity, and disposal services available? ! How much additional capacity is necessary? ! Does the lack of capacity prevent implementation? ! What additional provisions are required to ensure the needed additional capacity?
Availability of necessary equipment and specialists	! Are the necessary equipment and specialists available? ! What additional equipment and specialists are required? ! Does the lack of equipment and specialists prevent implementation? ! What additional provisions are required to ensure the needed equipment and specialists?

(Continued)

Table 2-21. (Concluded)

<u>Analysis factor</u>	<u>Specific factor considerations</u>
Availability of prospective technologies	! Are technologies under consideration generally available and sufficiently demonstrated for the specific application? ! Will technologies require further development before they can be applied full-scale to the type of waste at the site? ! When should the technology be available for full-scale use? ! Will more than one vendor be available to provide a competitive bid?

(d) Availability of necessary equipment and specialists, and provisions to ensure any necessary additional resources.

(e) Availability of services and materials, plus the potential for obtaining competitive bids, which may be particularly important for innovative technologies.

(f) Availability of prospective technologies.

g. Cost. A comprehensive discussion of costing procedures for CERCLA sites is contained in the Remedial Action costing Procedures Manual EPA/600 8-87/049 (U.S. EPA, October 1987). The application of cost estimates to the detailed analysis is discussed in the following paragraphs.

(1) Capital costs. Capital costs consist of direct (construction) and indirect (nonconstruction and overhead) costs. Direct costs include expenditures for the equipment, labor, and materials necessary to install remedial actions. Indirect costs include expenditures for engineering, financial, and other services that are not part of actual installation activities but are required to complete the installation of remedial alternatives. (Sales taxes normally do not apply to Superfund actions.) Costs that must be incurred in the future as part of the remedial action alternative should be identified and noted for the year in which they will occur. The distribution of costs over time will be a critical factor in making tradeoffs between capital-intensive technologies (including alternative treatment and distribution technologies) and less capital-intensive technologies (such as pump and treatment systems).

(a) Direct capital costs may include construction costs such as the costs of materials, labor and equipment required to install a remedial action, equipment costs such as the costs of remedial action and service equipment necessary to enact the remedy (these materials remain until the site remedy is complete), land and site-development costs such as expenses associated with the purchase of land and the site preparation costs of existing property, buildings and services costs such as the costs of process and nonprocess buildings, utility connections, purchased services, and disposal costs,

relocation expenses such as the costs of temporary or permanent accommodations for affected nearby residents, and disposal costs such as the costs of transporting and disposing of waste material such as drums and contaminated soils.

(b) Indirect capital costs may include engineering expenses such as the costs of administration, design, construction supervision, drafting, and treatability testing, license or permit costs such as administrative and technical costs necessary to obtain licenses and permits for installation and operation of offsite activities, startup and shakedown costs such as costs incurred to ensure system is operational and functional, and contingency allowances such as funds to cover costs resulting from unforeseen circumstances, such as adverse weather conditions, strikes, or contaminants not detected during site characterization.

(2) Annual/O&M costs. Annual O&M costs are postconstruction costs necessary to ensure the continued effectiveness of a remedial action. The following annual O&M cost components should be considered:

(a) Operating labor costs - Wages, salaries, training, overhead, and fringe benefits associated with the labor needed for postconstruction operations.

(b) Maintenance materials and labor costs - Costs for labor, parts, and other resources required for routine maintenance of facilities and equipment.

(c) Auxiliary materials and energy - Costs of such items as chemicals and electricity for treatment plant operations, water and sewer services, and fuel.

(d) Disposal of residues - Costs to treat or dispose of residuals such as sludges from treatment processes or spent activated carbon.

(e) Purchased services - Sampling costs, laboratory fees, and professional fees for which the need can be predicted.

(f) Administrative costs - Costs associated with the administration of remedial O&M not included under other categories.

(g) Insurance, taxes, and licensing costs - Costs of such items as liability and sudden accidental insurance; real estate taxes on purchased land or rights-of-way; licensing fees for certain technologies; and permit renewal and reporting costs.

(h) Maintenance reserve and contingency funds - Annual payments into escrow funds to cover costs of anticipated replacement or rebuilding of equipment and any large unanticipated O&M costs.

(i) Rehabilitation costs - cost for maintaining equipment of structures that wear out over time.

(j) Costs of periodic site reviews - Costs for site reviews that are conducted at least every 5 years if wastes above health-based levels remain at the site.

(3) Future costs. The costs of potential future remedial actions should be addressed and should be included when there is a reasonable expectation that a major component of the alternative will fail and require replacement to prevent significant exposure to contaminants. Analyses of "long-term effectiveness and permanence" should be used to determine which alternatives may result in future costs. It is not expected that a detailed statistical analysis will be required to identify probable future costs. Rather, qualitative engineering judgment should be used and the rationale documented in the FS report.

(4) Accuracy of cost estimates. Site characterization and treatability investigation information should permit the user to refine cost estimates for remedial action alternatives in the FS. Typically, these "study estimate" costs made during the FS are expected to provide an accuracy of +50 percent to -30 percent and are prepared using data available from the RI. It should be indicated when it is not realistic to achieve this level of accuracy.

(5) Present worth analysis.

(a) A present worth analysis is used to evaluate expenditures that occur over different time periods by discounting all future costs to a common base year, usually the current year. This allows the cost of remedial action alternatives to be compared on the basis of a single figure representing the amount of money that, if invested in the base year and disbursed as needed, would be sufficient to cover all costs associated with the remedial action over its planned life.

(b) In conducting the present worth analysis, assumptions must be made regarding the discount rate and the period of performance. The Superfund program recommends that a discount rate of 5 percent before taxes and after inflation be assumed. Estimates of costs in each of the planning years are made in constant dollars, representing the general purchasing power at the time of construction. In general, the period of performance of costing purposes should not exceed 30 years for the purpose of the detailed analysis.

(6) Cost sensitivity analysis.

(a) After the present worth of each remedial action alternative is calculated, individual costs may be evaluated through a sensitivity analysis if there is sufficient uncertainty concerning specific assumptions. A sensitivity analysis assesses the effect that variations in specific assumptions associated with the design, implementation, operation, discount rate, and effective life of an alternative can have on the estimated cost of the alternative. These assumptions depend on the accuracy of the data developed during the site characterization and treatability investigation and on predictions of the future behavior of the technology. Therefore, these assumptions are subject to varying degrees of uncertainty from site to site. The potential effect on the cost of an alternative because of these

uncertainties can be observed by varying the assumptions and noting the effects on estimated costs. Sensitivity analyses can also be used to optimize the design of a remedial action alternative, particularly when design parameters are interdependent (e.g., treatment plant capacity for contaminated ground water and the length of the period of performance).

(b) Use of sensitivity analyses should be considered for the factors that can significantly change overall costs of an alternative with only small changes in their values, especially if the factors have a high degree of uncertainty associated with them. Other factors chosen for analysis may include those factors for which the expected (or estimated) value is highly uncertain. The results of such an analysis can be used to identify worst-case scenarios and to revise estimates of contingency or reserve funds.

(c) The following factors are potential candidates for consideration in conducting a sensitivity analysis: the effective life of a remedial action, the operation and maintenance costs, the duration of cleanup, the volume of contaminated material, given the uncertainty about site conditions, and other design parameters (e.g., the size of the treatment system).

(d) The 5 percent discount rate should be used to compare alternative costs; however, a range of 3 to 10 percent can be used to investigate uncertainties.

(e) The results of a sensitivity analysis should be discussed during the comparison of alternatives. Areas of uncertainty that may have a significant effect on the cost of an alternative should be highlighted, and a rationale should be presented for selection of the most probable value of the parameter.

h. State (Support Agency) Acceptance. This assessment evaluates the technical and administrative issues and concerns the state (or support agency in the case of state-lead sites) may have regarding each of the alternatives. As discussed earlier, this criterion will be addressed in the ROD once comments on the RI/FS report and proposed plan have been received.

i. Community Acceptance. This assessment evaluates the issues and concerns the public may have regarding each of the alternatives. As with state acceptance, this criterion will be addressed in the ROD once comments on the RI/FS report and proposed plan have been received.

2-25. Presentation of Individual Analyses.

a. The analysis of individual alternatives with respect to the specified criteria should be presented in the FS report as a narrative discussion accompanied by a summary table. This information will be used to compare the alternatives and support a subsequent analysis of the alternatives made by the decisionmaker in the remedy selection process. The narrative discussion should, for each alternative, provide a description of the alternative and a discussion of the individual criteria assessment.

b. The alternative description should provide data on technology components (use of innovative technologies should be identified), quantities of hazardous materials handled, time required for implementation, process sizing, implementation requirements, and assumptions. These descriptions, by clearly articulating the various waste management strategies for each alternative, will also serve as the basis for documenting the rationale of the applicability or relevance and appropriateness of potential Federal and state requirements. Therefore, the significant ARARs for each alternative should be identified and integrated into these discussions.

c. The narrative discussion of the analysis should, for each alternative, present the assessment of the alternative against each of the criteria. This discussion should focus on how, and to what extent, the various factors within each of the criteria are to be addressed.

d. As noted previously, state and community acceptance will be addressed in the ROD once concerns have been received on the RI/FS report and proposed plan. The uncertainties associated with specific alternatives should be included when changes in assumptions or unknown conditions could affect the analysis (e.g., the time to attain ground-water cleanup targets may be twice as long as estimated if assumptions made about aquifer characteristics for a specific ground-water extraction alternative are incorrect).

e. The FS also should include a summary table highlighting the assessment of each alternative with respect to each of the nine criteria.

2-26. Comparative Analysis of Alternatives.

a. Once the alternatives have been described and individually assessed against the criteria, a comparative analysis should be conducted to evaluate the relative performance of each alternative in relation to each specific evaluation criterion. This is in contrast to the preceding analysis in which each alternative was analyzed independently without a consideration of other alternatives. The purpose of this comparative analysis is to identify the advantages and disadvantages of each alternative relative to one another so that the key tradeoffs the decisionmaker must balance can be identified.

b. Overall protection of human health and the environment and compliance with ARARs will generally serve as threshold determinations in that they must be met by any alternative in order for it to be eligible for selection. The next five criteria (long-term effectiveness and permanence; reduction of toxicity, mobility, and volume through treatment; short-term effectiveness; implementability; and cost) will generally require the most discussion because the major tradeoffs among alternatives will most frequently relate to one or more of these five.

c. State and community acceptance will be addressed in the ROD once formal comments on the RI/FS report and the proposed plan have been received and a final remedy selection decision is being made.

2-27. Presentation of Comparative Analysis.

a. The comparative analysis should include a narrative discussion describing the strengths and weaknesses of the alternatives relative to one another with respect to each criterion, and how reasonable variations of each alternative may be addressed.

b. The factors presented in Tables 2-18 through 2-21 have been included to illustrate typical concerns that may need to be addressed during the detailed analysis. It will not be necessary or appropriate in all situations to address every factor in these tables for each alternative being evaluated. Under some circumstances, it may be useful to address other factors not presented in these tables to ensure a better understanding of how an alternative performs with respect to a particular criterion.

c. Key uncertainties could change the expectations of their relative performance. An effective way of organizing this presentation is, under each individual criterion, to discuss the alternative that performs the best overall in that category, with other alternatives discussed in the relative order in which they perform. If innovative technologies are being considered, their potential advantages in cost or performance and the degree of uncertainty in their expected performance (as compared with more demonstrated technologies) should also be discussed.

d. The presentation of differences among alternatives can be measured either qualitatively or quantitatively, as appropriate, and should identify substantive differences (e.g. , greater short-term effectiveness concerns, greater cost, etc.). Quantitative information that was used to assess the alternatives (e.g. , specific cost estimates, time until response objectives would be obtained, and levels of residual contamination) should be included in these discussions.

2-28. Post-RI/FS Selection of the Preferred Alternative. Following completion of the RI/FS, the results of the detailed analyses, when combined with the risk management judgments made by the decisionmaker, become the rationale for selecting a preferred alternative and preparing the proposed plan. Therefore, the results of the detailed analysis, or more specifically the comparative analysis, should serve to highlight the relative advantages and disadvantages of each alternative so that the key tradeoffs can be identified. It will be these key tradeoffs coupled with risk management decisions that will serve as the basis for the rationale and provide a transition between the RI/FS report and the development of a proposed plan (and ultimately a ROD).

2-29. Community Relations During Detailed Analysis.

a. Site-specific community relations activities should be identified in the community relations plan prepared previously. While appropriate modifications of activities may be made to the community relations plan as the project progresses, the plan should generally be implemented as written to ensure that the community is informed of the alternatives being evaluated and

is provided a reasonable opportunity to provide input to the decision making process.

b. A fact sheet may be prepared that summarizes the feasible alternatives being evaluated. Small group consultations or public meetings may be held to discuss community concerns and explain alternatives under consideration. Public officials should be briefed and press releases prepared describing the alternatives. Other activities identified in the community relations plan should be implemented.

c. The objective of community relations during the detailed analysis is to assist the community in understanding the alternatives and the specific considerations the lead agency must take into account in selecting an alternative. In this way, the community is prepared to provide meaningful input during the upcoming public comment period.

2-30. Removal Activities.

a. Removals are the other type of response action that may be undertaken. Removals are expedited response actions as opposed to long-term action undertaken during remedial activities. There are two types of removal actions: time critical and non-time critical.

b. Removals may be implemented any time during the remedial action process. Most time-critical removals will be implemented within a short period following the discovery of a site. However, some imminent threats may not be revealed until construction during remedial action. Typical time-critical/non-time critical removals are shown in the flow chart in Figure 2-15.

c. RCRA has a parallel authority for implementing short-term responses to a release prior to full implementation of the corrective measure. The RCRA procedure is called an Interim Measure. RCRA Interim Measures must meet the requirements of all Federal, state, and local laws and regulations. Currently, there is no ARAR process equivalent under RCRA.

d. Under the FUDS program, removal actions also include building demolition/debris removal and abandoned ordnance-explosive waste removal.

2-31. Time-Critical Removal Actions

a. Time-critical removal actions are actions initiated in response to a release or threat of a release that poses a risk to public health or the environment, such that cleanup or stabilization actions must be initiated within 6 months following approval of the Action Memorandum. The typical flow of events for a time-critical action is shown in Figure 2-16. The two key items are the Action Memorandum and the Administrative Record. The Action Memorandum serves as the decision document that must accompany any CERCLA action. It corresponds to the ROD for a full remedial response. Because of the immediate nature of a time-critical removal action, the regulations do not require that the Administrative Record be available prior to the implementation of the action. However, all CERCLA actions must have an

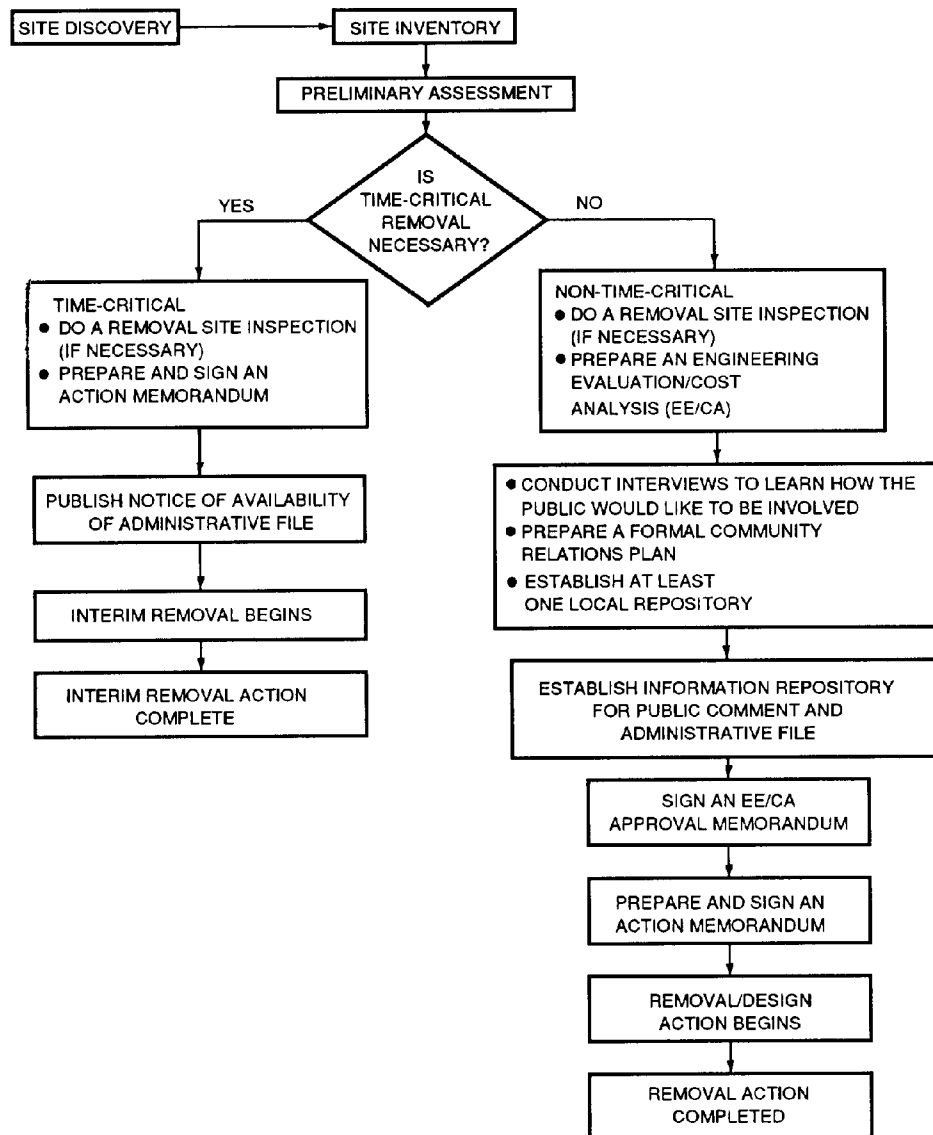

Figure 2-15. Typical Flow Chart for Time-Critical/Non-Time-Critical Removals

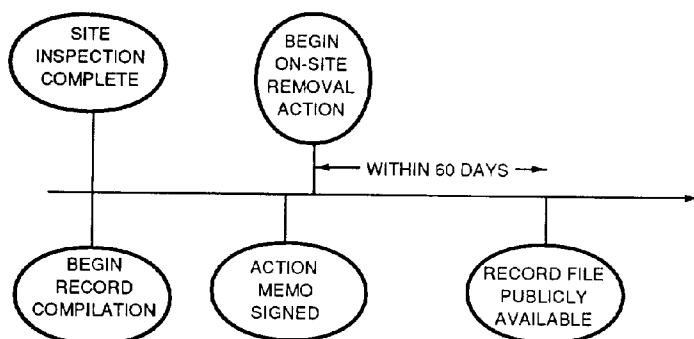

Figure 2-16. General Elements of a Typical Time-Critical Removal Action

Administrative Record and it must be open to the public for review and inspection.

b. Typical time-critical removal actions include:

- (1) Fences to limit access to the site.
- (2) Drainage control to limit the off-site migration of contaminants.
- (3) Capping or containment of the contaminants on the site.
- (4) Removal of containers of waste remaining on the site.
- (5) Provision of alternative water supplies to citizens impacted by contaminated water.
- (6) Stabilization of berms, dikes, or impoundments or the drainage or closing of lagoons.
- (7) Using chemicals or other materials to retard the spread of contaminants or mitigate their effects.
- (8) Excavation, consolidation, or removal of ordnance and explosive waste (OEW) or soils having an imminent safety threat contaminated by OEW or HTRW where such action will reduce the spread of or contact with these wastes and reduce the threat of fire or explosion.
- (9) Containment, treatment, disposal, or incineration of hazardous substances to reduce the likelihood of human, animal, or food chain exposure.

c. Depending on the urgency of the situation, time-critical removals implemented in response to an imminent threat need not be compatible with future non-time-critical removals or remedial actions, need not be shown to be

cost effective, and need not achieve applicable or relevant and appropriate requirements (ARARs). However, time and other conditions permitting, these objectives should be considered. When making this determination, the urgency for a time-critical removal action should be documented and maintained in the project file along with the Action Memorandum.

2-32. Non-Time-Critical Removal Actions.

Non-time-critical removal actions are actions initiated in response to a release or threat of a release that poses a risk to human health, its welfare, or the environment such that initiation of removal cleanup or stabilization actions may be delayed for 6 months or more following approval of the Action Memorandum. The typical flow of events is shown in Figure 2-17. In the non-time-critical case, a 30-day comment period must be provided prior to the implementation of the action, and the Administrative Record must be available for review during that time. An Action Memorandum (taking the place of the ROD or the decision document) is also prepared and signed. One additional document is prepared in the case of a non-time-critical action--the Engineering Evaluation/Cost Analysis (EE/CA). This document takes the place of the RI/FS that is prepared for full remedial action.

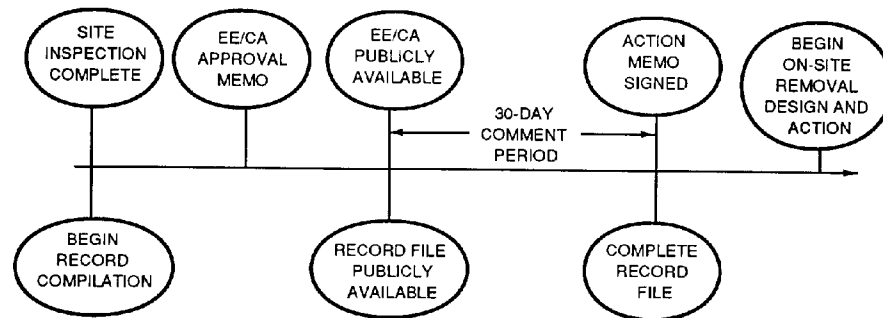

Figure 2-17. General Elements of a Typical Non-Time-Critical Removal Action

2-33. Removal Action Process.

a. Removal Site Inspection (RSI) (if necessary). The site inspection is an on-site inspection to determine the nature of the release or potential release and the nature of the associated threats. The purpose is to augment the data collected in the preliminary assessment and to generate, if necessary, sampling and other field data to determine if an EE/CA is appropriate. RSIs are typically performed for non-time-critical removal actions in accordance with 40 CFR 300.410.

b. EE/CA. For non-time-critical removal actions, CERCLA allows an EE/CA to be performed in lieu of an RI/FS. If the removal action is undertaken to partially fulfill a signed ROD (for a National Priority List (NFL) site), an EE/CA and public comment are not required. Under those circumstances, the RI/FS and associated public participation procedures fulfill the EE/CA requirements. The EE/CA process applies only to those actions determined at the outset to be non-time-critical. The principal steps in the EE/CA process are summarized in Table 2-22. The format for the EE/CA is summarized in Table 2-23. The EE/CA must meet the following requirements.

(1) Satisfy environmental review requirements applicable to removal action (including National Environmental Policy Act (NEPA) review equivalency).

(2) Satisfy administrative record requirements (documentation of removal action selection, public comment, and responsiveness summary).

(3) Provide a framework for evaluating and selecting alternative technologies (permanent solutions and alternative treatment technologies are to be stressed).

c. Decision Document. After completion of an EE/CA, a decision document, called an Action Memorandum, is prepared to identify the removal action chosen for implementation at a FUDS. The decision document is based on information contained in the EE/CA and consideration of public comments and community concerns.

d. Removal Design. The purpose of the removal design is to develop detailed designs, plans, specifications, and bid documents for conducting the removal action. The development of the removal design must ensure that Federal and state requirements, including any conditions or waivers to ARARs, have been identified and incorporated into the design.

e. Removal Action. After the removal design package is completed and approved, the removal action is implemented. The removal action starts with the solicitation and awarding of a contract, continues through completion of interim and final inspections, certification, and culminates with acceptance of the final project.

f. Site Closeout. A closed-out site is one in which the removal action is considered complete. The primary criterion for site closeout is a determination that the site is no longer a potential or significant threat to the public health or the environment. A site closeout document is prepared for each site or group of sites for which the site closeout decision is made. The site closeout document should clearly identify the site; reference the data, studies, and other evidence on which the decision is based; and describe the rationale for the decision.

Table 2-22. Key Steps in the EE/CA Process

EE/CA Steps	Activities
Site Inspection (SI)	! Review of removal preliminary assessment/site investigation (PA/SI) indicates that a removal action is appropriate, but that the threat is non-time-critical.
Potentially Responsible Party (PRP) Notice	! Issuance of a general notice (required) or a special notice (discretionary).
Approval and Initiation of EE/CA Study	! Approval memorandum prepared which documents that the site meets criteria for a removal action and secures management approval to conduct EE/CA also, designate site spokesman, open Administration Record, initiate community interviews, and prepare Community Relations Plan.
Complete EE/CA Study and Report	! Complete any additional on-site data collection activities necessary to better characterize the waste and define site conditions (see CERCLA Section 104(b)). Compile all appropriate removal/remedial action alternatives and analyze each for effectiveness, cost, and ability to implement. Conclude with recommended removal/remedial action(s). Cleanup measures are not permitted.
Release EE/CA Report	! Place EE/CA report in Administrative Record; publish notice of availability and summary; complete Community Relations Plan.
Public Comment	! Provide for 30-day public comment period on the EE/CA and other documents in the Administrative Record.
Action Memorandum	! Prepare Action Memorandum describing the proposed removal action and soliciting management approval to implement the action. Attach a Responsiveness Summary (including a summary of significant public comments and responses to these comments). Close the Administrative Record when Action Memorandum is signed.
Implement Removal Action	! Observe conditions of the EE/CA, on the implementation of the removal action, but not including any previous Section 104(b) activities.

Table 2-23 Outline and Contents of the EE/CA

Topic	Description of Contents
Site Characterization	Site description - location, surrounding land uses, nature and extent of contamination. Site background - prior site uses, site history, regulatory involvement. Analytical data - summarize analytical results Site conditions that justify a removal.
Removal Action Objectives	Removal action scope - describe scope of the project and identify any threats that will not be addressed. Removal action schedule. Applicable or relevant and appropriate requirements.
Removal Action Alternatives	A description of appropriate alternative actions for the site (Note: a no-action alternative is not required). Innovative technologies should be considered and evaluated.
Analysis of Alternatives	Each alternative should be individually evaluated based on the criteria below: ! Effectiveness - Protectiveness Protection of the community during removal Protection of workers during removal Threat reduction Time until protection is achieved Compliance with chemical and location - Specific ARARs Environmental impacts Potential exposure to remaining risks Long-term reliability - Use of alternatives to land disposal ! Ability to implement - Technical feasibility Ability to construct and operate - Compliance with action-specific ARARs - Ability to meet performance goals Demonstrated performance Compliance with long-term clean-up goals

(Continued)

Table 2-23. (Concluded)

Topic	Description of Contents
Analysis of Alternatives (con*t)	<ul style="list-style-type: none">! Availability<ul style="list-style-type: none">- Equipment, materials, and personnel- Off-site capacity (if needed)- Postremoval site control ! Administrative feasibility<ul style="list-style-type: none">- Public acceptance- Coordination with other agencies- Required permits of approvals (off-site only) ! Cost<ul style="list-style-type: none">- Total cost (present worth)- Statutory limits
Comparative Analysis of Alternatives	
Proposed Removal Design and Removal Action	

CHAPTER 3

CONTROL AND CONTAINMENT TECHNOLOGIES

3-1. Definition. Control and containment technologies are those remedial systems that are used primarily for management of contaminants onsite and to prevent excursions to the air or ground water.

3-2. Applicability. Control and containment remedial techniques are usually undertaken where the volume of waste or hazard associated with the waste makes it impractical or impossible to dispose of the contamination offsite to a secure landfill site or to treat the waste or contaminated material onsite. In some cases, portions of waste materials have been removed, but the residual contamination in soil and ground water must be contained onsite. Remedial techniques generally are used for onsite containment with processes such as flushing of an aquifer or natural biological degradation accounting for the actual destruction of contaminants. Site control and containment remedial techniques are often implemented along with treatment systems to minimize the volume of material requiring treatment. For example, if leachate seeps from the site it must be treated, and control of run-on and percolation through the site can reduce the volume of water that must be collected and treated.

3-3. Techniques.

a. Waste Collection and Removal. The first step in remediation is usually the collection and removal of waste materials, including wastes, soils, sediments, liquids, and sludges.

b. Contaminated Ground Water Plume Management. Often it is necessary to control contaminant movement in the subsurface by intercepting or controlling leachate and ground water around and under a site.

c. Surface Water Controls. Control and containment technologies usually involve managing the movement of contaminants in and out of the controlled area. Many common construction processes used in managing ground water and surface water are often employed. Leachate control involves containment and collection of water contaminated by contact with hazardous wastes. Control of leachate will involve the use of subsurface drains and liners.

d. Gas Control. Gases and volatile compounds must be controlled at many hazardous waste sites both to allow access to the area and to prevent wider dispersion of contaminants.

Section I. Waste Collection and Removal

3-4. Drum Handling.

a. Background.

(1) The disposal of drums containing wastes in landfills and at abandoned storage facilities has been common practice in the United States.

Many of the problems with uncontrolled disposal sites can, in part, be linked to improper drum disposal. In addition to contributing to ground-water, soil, air, and surface-water contamination, several explosions and fires, resulting from incompatible wastes can be attributed to leaking drums.

(2) Since each disposal site is different, selection and implementation of equipment, and methods for handling drum-related problems, must be independently determined. The primary factors that influence the selection of equipment or methods include worker safety, site-specific variables affecting performance, environmental protection, and costs. All sites should include the construction of earthen dikes and installation of synthetic liners in the drum-handling area to minimize seepage and run-off of spilled materials, and the use of real-time, air-monitoring equipment during all phases of site activity.

(3) The organization of a typical drum cleanup site is shown in Figure 3-1.

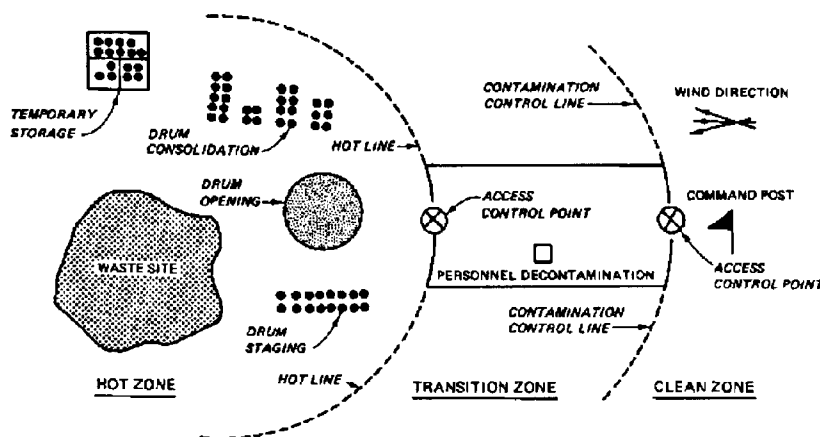

Figure 3-1. Organization of the Waste Site Cleanup Area

b. Drum-Handling Activities.

(1) Site-specific variables. The safety of drum handling is greatly affected by site-specific conditions, including accessibility of the site, drum integrity, surface topography and drainage, number of drums, depth of burial, and the type of wastes present.

(2) Detecting and locating drums. Typically, drums at an abandoned site will be detected through the use of historic and background data on the site, aerial photography, geophysical surveying, and sampling. Background data and aerial photography records which will show changes in the site over time, such as filling in of trenches and mounding of earth, should be available onsite during the construction phase of the remedial action to

determine if the drum location is as predicted. Geophysical survey methods are highly dependent upon site-specific characteristics. Magnetometry is usually the most useful survey method for locating buried drums. Metal detectors, ground penetrating radar, and electromagnetics are also used to detect buried drums with varying success. Regardless of the geophysical method used to determine the location of buried drums, the results must be verified by sampling.

(3) Environmental protection. Four basic techniques for environmental protection which should be practiced at all sites are: (a) measures to prevent contaminant releases, such as overpacking or pumping the contents of leaking drums; (b) actions which mitigate or contain releases once they have occurred, such as perimeter dikes, (c) avoidance of uncontrolled mixing of incompatible wastes by handling only one drum at a time during excavation, and (d) isolating drum-opening operation from staging and working areas. Some of the preventive measures and mitigating actions for minimizing contaminant releases during drum-handling activities are summarized in Table 3-1.

(4) Determining drum integrity. The excavation and handling of damaged drums can result in spills and reactions which may jeopardize worker safety and public health. Generally a drum is inspected visually to check the drum surface for corrosion, leaks, swelling, and missing bungs. Worker safety should be stressed during this inspection since it requires close contact with the drum. Any drum that is critically swollen should not be approached. Swollen drums should be isolated behind a barrier and the pressure released remotely. Nondestructive testing methods to determine drum integrity have been found to have serious drawbacks and limitations. Most of these methods such as ultrasonics or eddy currents require that the drum surface be relatively clean and free from chipped paint and floating debris. Buried drums are usually not in condition to be safely and easily cleaned.

(5) Container opening, sampling, and compatibility. Each container on a site may have to be opened, sampled, and analyzed prior to disposal.

(a) Container opening and sampling should be conducted in an isolated area to minimize the potential of explosions and fires should the drum rupture or the contents spill. Drum-opening tools include hand tools (nonsparking hand tools, bung wrenches, and deheaders) and remotely operated plungers, debungers, and backhoe-attached spikes. EPA's National Enforcement Investigations Center (NEIC) has developed two remotely controlled drum opening devices. Procedures for drum opening and sampling are outlined in Appendix XIV of the Chemical Manufacturers Association, Inc. (CMA), report "A Hazardous Waste Site Management Plan.

(b) Compatibility testing is required prior to bulking, storing, or shipping many of the containers. Compatibility testing should be rapid, using onsite procedures for assessing waste reactivity, solubility, presence of oxidizer, water content, acidity, etc. A compatibility testing procedure is also outlined in Appendix XV of the CMA report.

(6) Drum consolidation and recontainerization.

Table 3-1. Measures for Minimizing Contaminant Releases during Drum Handling

Potential environmental problem	Preventive measures
Ground-water contamination	<p>Improve site drainage around the drum-handling area and minimize run-on and run-off by constructing a system of dikes and trenches.</p> <p>Where ground water is an important drinking water source; it may be necessary to hydrologically isolate the work area using well-point dewatering.</p> <p>Use liners to prevent leaching of spilled material into ground water during drum handling, drum opening, recontainerization, and decontamination.</p> <p>Use sorbents or vacuum equipment to clean up spills promptly.</p> <p>Locate a temporary storage area on highest ground area available; install an impervious liner in the storage area and a dike around the perimeter of the area; utilize a sump pump to promptly remove spills and rainwater from storage area for proper handling.</p>
Surface-water contamination	<p>Construct dikes around the drum-handling and storage areas.</p> <p>Construct a holding pond downslope of the site to contain contaminated run-off.</p> <p>Use sorbents or vacuum equipment to promptly clean up spills.</p> <p>Design the dikes for temporary storage area to contain a minimum of 10 percent of total waste volume; ensure that holding capacity of storage area is not exceeded by utilizing a sump pump to promptly remove spills and rainwater.</p>
Air pollution	<p>Avoid uncontrolled mixing of incompatible wastes by (1) handling only one drum at a time during excavation, (2) isolating drum-opening operation from staging and working areas, (3) pumping or overpacking leaking drums, and (4) conducting compatibility tests on all drums.</p>

(Continued)

Table 3-1. (Concluded)

Potential environmental problem	Preventive measures
Air pollution (Cont.)	<p>Promptly reseal drums following sampling.</p> <p>Any drum which is leaking or prone to rupture or leaking, promptly overpack or transfer the contents to a new drum.</p> <p>Utilize vacuum units which are equipped with vapor scrubbers.</p> <p>Where incompatible wastes are intentionally mixed (i.e., acids and bases for neutralization) in a "compatibility chamber" or tank, releases of vapors can be minimized by covering the tank with plastic liner.</p>
Fire protection	<p>Use nonsparking hand tools, drum-opening tools, and explosion-proof pumps when handling flammable, explosive, or unknown waste.</p> <p>Avoid uncontrolled mixing of incompatible waste by (1) handling only one drum at a time, (2) pumping or overpacking drums with poor integrity, (3) isolating drum opening, and (4) conducting compatibility testing of all drums.</p> <p>Use sand or foams to suppress small fires before they spread.</p> <p>Avoid storage of explosives or reactive wastes in the vicinity of buildings.</p> <p>In a confined area, reduce concentration of explosives by venting to the atmosphere.</p> <p>Cover drums which are known to be water-reactive.</p>

(a) A proposed drum consolidation protocol that can be used as a guide in assessing drum consolidation requirements was also prepared by the CMA. The protocol is based on grouping the waste into categories that are compatible based on limited testing rather than doing individual analyses of the contents of each drum prior to disposal. This approach would be best suited to a manufacturing facility where the products or wastes types are limited and the objective is to consolidate many samples into a relatively small number of waste streams for bulk disposal. In the case where a disposal method is based on concentrations of a particular waste constituent (e.g., concentration of PCBs), care must be taken not to consolidate containers into bulk streams that would substantially alter the method for disposal, subsequently increasing the costs for the remedial action.

(b) In the case where consolidation is not feasible, based on incompatibility of wastes or costs, drums can be overpacked, contents transferred to new drums, or contents solidified to facilitate handling.

(7) Storage and shipping. Temporary onsite storage of drums may be part of the remedial action prior to ultimate disposal. Requirements for storage of hazardous wastes over 90 days are regulated under the RCRA. RCRA-permitted facilities for drum storage for over 90 days require:

(a) Use of dikes or berms to enclose the storage area and to segregate incompatible waste types.

(b) Installation of a base or liner that is impermeable to spills.

(c) Sizing of each storage area (containing compatible wastes) so that it is adequate to contain at least 10 percent of the total waste volume in event of a spill.

(d) Design of the storage area so that drums are not in contact with rainwater or spills for more than one hour.

(e) Weekly inspections.

(8) Technical standards. The technical standards for these requirements are found in 40 CFR Parts 264-265. Manifesting and shipping of the hazardous wastes are covered by DOT regulations found in 49 CFR 171-177, 40 CFR 263, and other applicable Federal, state, and local laws and regulations. A RCRA storage permit will be required for onsite storage of hazardous waste held over 90 days.

3-5. Storage. Storage is the holding of a waste for a temporary period of time, at the end of which the waste is treated, disposed of, or stored elsewhere.

a. Applicability.

(1) Storage systems have general applicability to all types of waste streams as a mechanism for accumulating and holding waste on a temporary basis. Storage should be considered viable only in cases where the

accumulation of waste prior to treatment or disposal results in a cost reduction or makes some treatment process or disposal method more feasible. Examples include accumulation of waste until a sufficient volume is obtained for bulk shipment or bulk treatment, thus decreasing costs. Under the RCRA regulations, a generator may accumulate hazardous waste onsite without a permit for a period of up to 90 days as long as certain conditions are met as specified in CFR Title 40, Part 262, Subpart C, Section 262.34.

(2) Different storage techniques are capable of handling wastes in solid, semisolid, and liquid forms. Problems associated with the applicability of storage techniques to various wastes generally occur with regard to storage of hazardous waste. The RCRA regulations pertaining to storage facilities under Part 264 address two particular problem wastes, ignitable or reactive wastes and incompatible wastes. Special requirements for each storage technique are detailed in the regulations for these wastes.

(3) Wastes that emit or produce toxic fumes should not be stored in a manner which allows for the emission of fumes except possibly in emergency situations.

b. Methods. Storage methods include waste piles, surface impoundments, containers, and tanks.

(1) Waste piles. Waste piles are small noncontainerized accumulations of a single solid dry nonflowing waste. They may be maintained in buildings or outside on concrete or other pads. Waste pile storage is suitable for semisolid and solid hazardous wastes such as mine tailings or unexploded ordnance wastes. The siting criteria for waste piles are less stringent than those for landfills or surface impoundments. Waste piles should be located in a hydrogeologic setting that offers both sufficient vertical separation of wastes from uppermost ground water and low permeability soils providing the hydraulic separation. The design elements required by the regulations for waste piles include liner, leachate collection and removal, run-on and run-off control, and wind dispersal control.

(a) Liners selected for a waste pile must be compatible with the waste material and be able to contain the waste until closure. Considerable flexibility is permitted in the choice of liners for short-term storage of wastes. A liner may be constructed of clay, synthetic materials, or admixes. Table 3-2 summarizes liner types, characteristics, and compatibilities. If a waste pile is going to be used for an extended period of time, a double liner with a leachate collection system may be required. Figure 3-2 illustrates waste pile details and a double liner system. If the waste pile contains particulate matter, wind dispersal controls are required by the regulations.

(b) The principal closure requirement for a waste pile is removal or decontamination of all waste and waste residue and all system components (liners), subsoils, structures, and equipment which have been contaminated by contact with the waste. However, if contamination of the subsoils is so extensive as to preclude complete removal or decontamination, the closure and postclosure requirements applying to landfills must be observed. Ensuring

Table 3-2. Summary of Liner Types

Liner material	Characteristics	Range of costs ¹	Advantages	Disadvantages
Soils Compacted clay soils	Compacted mixture of onsite soils to a permeability of 10^{-7} cm/sec	L	High cation exchange capacity; resistant to many types of leachate	Organic or inorganic acids or bases may solubilize portions of clay structure
Soil bentonite	Compacted mixture of onsite soil, water, and bentonite	L	High cation exchange capacity; resistant to many types of leachate	Organic or inorganic acids or bases may solubilize portions of clay structure
Admixes Asphalt concrete	Mixtures of asphalt cement and high-quality mineral aggregate	M	Resistant to water and effects of weather extremes; stable on side slopes; resistant to acids, bases, and inorganic salts	Not resistant to organic solvents; partially or wholly soluble in hydrocarbons; does not have good resistance to inorganic chemicals; high gas permeability
Asphalt membrane	Core layer of blown asphalt blended with mineral fillers and reinforcing fibers	M	Flexible enough to conform to irregularities in subgrade; resistant to acids, bases, and inorganic salts	Ages rapidly in hot climates; not resistant to organic solvents, particularly hydrocarbons
Soil asphalt	Compacted mixture of asphalt, water, and selected in-place soils	L	Resistant to acids, bases, and salts	Not resistant to organic solvents, particularly hydrocarbons
Soil cement	Compacted mixture of portland cement, water, and selected in-place soils	L	Good weathering in wet-dry/freeze-thaw cycles; can resist moderate amount of alkali, organics, and inorganic salts	Degraded by highly acidic environments
Polymeric membranes Butyl rubber	Copolymer of isobutylene with small amounts of isoprene	M	Low gas and water vapor permeability; thermal stability; only slightly affected by oxygenated solvents and other polar liquids	Highly swollen by hydrocarbon solvents and petroleum oils difficult to seam and repair
Chlorinated polyethylene	Produced by chemical reaction between chlorine and high-density polyethylene	M	Good tensile strength and elongation strength; resistant to many inorganics	Will swell in presence of aromatic hydrocarbons and oils

(Continued)

¹ L - \$1.12 to \$4.78 per square meter (\$1 to \$4 installed costs per square yard) in 1981 dollars; M - \$4.78 to \$9.57 /m² (\$4 to \$8 per square yard); H - \$9.57 to \$14.35 /m² (\$8 to \$12 per square yard). (Source: "Comparative Evaluation of Incinerators and Landfills," prepared for the Chemical Manufacturers Association, by Engineering Science, McLean, VA, May 1982).

Table 3-2. (Concluded)

Liner material	Characteristics	Range of costs	Advantages	Disadvantages
Polymeric membranes (Cont.)				
Chlorosulfonate polyethylene	Family of polymers prepared by reacting polyethylene with chlorine and sulfur dioxide	H	Good resistance to ozone, heat, acids, and alkalis	Tends to harden on aging; low tensile strength; tendency to shrink from exposure to sunlight; poor resistance to oil
Elasticized polyolefins	Blend of rubbery and crystalline polyolefins	L	Low density; highly resistant to weathering, alkalis, and acids	Difficulties with low temperatures and oils
Epichlorohydrin rubbers	Saturated high molecular weight, aliphatic polyethers with chloromethyl side chains	M	Good tensile and tear strength; thermal stability; low rate of gas and vapor permeability; resistant to ozone and weathering; resistant to hydrocarbons, solvents, fuels, and oils	None reported
Ethylene propylene rubber	Family of terpolymers of ethylene, propylene, and nonconjugated hydrocarbon	M	Resistant to dilute concentrations of acids, alkalis, silicates, phosphates, and brine; tolerates extreme temperatures; flexible at low temperatures; excellent resistance to weather and ultraviolet exposure	Not recommended for petroleum solvents of halogenated solvents
Neoprene	Synthetic rubber based on chloroprene	H	Resistant to oils, weathering, ozone, and ultraviolet radiation; resistant to puncture, abrasion, and mechanical damage	None reported
Polyethylene	Thermoplastic polymer based on ethylene	L	Superior resistance to oils, solvents, and permeation by water vapor and gases	Not recommended for exposure to weathering and ultraviolet light conditions
Polyvinyl chloride	Produced in roll form in various widths and thicknesses; polymerization of vinyl chloride monomer	L	Good resistance to inorganics; good tensile, elongation, puncture, and abrasion resistant properties; wide ranges of physical properties	Attacked by many organics, including hydrocarbons, solvents, and oils; not recommended for exposure to weathering and ultraviolet light conditions
Thermoplastic elastomers	Relatively new class of polymeric materials ranging from highly polar to nonpolar	M	Excellent oil, fuel, and water resistance with high tensile strength and excellent resistance to weathering and ozone	None reported

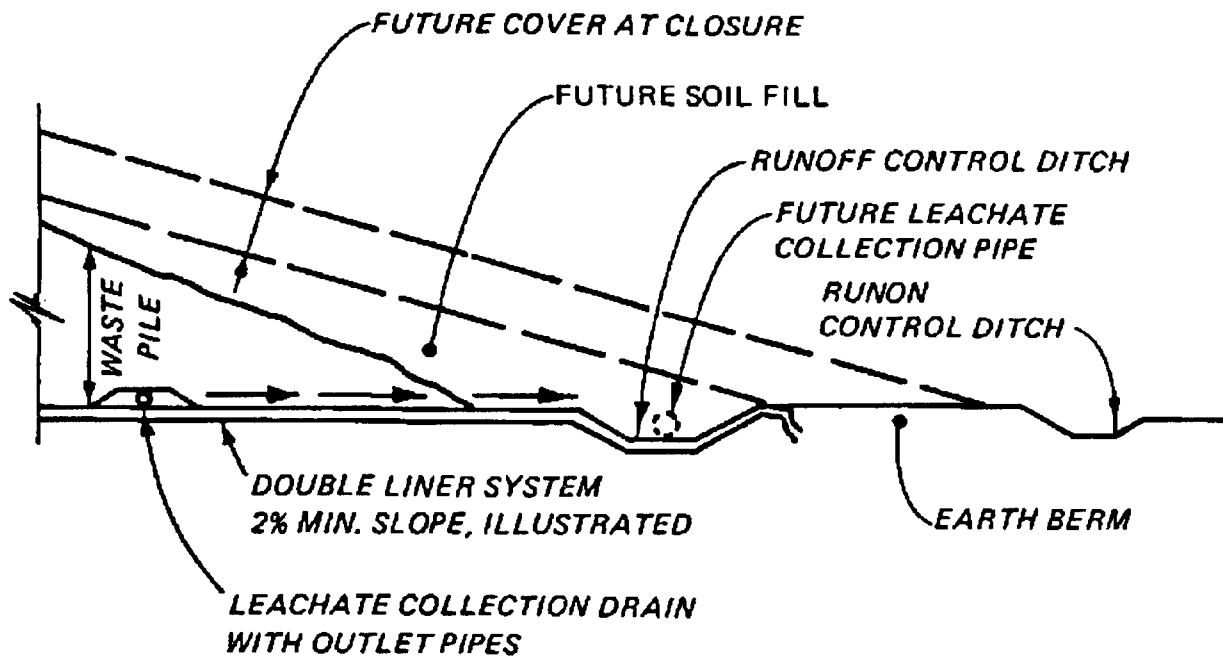

TYPICAL WASTE PILE DETAILS

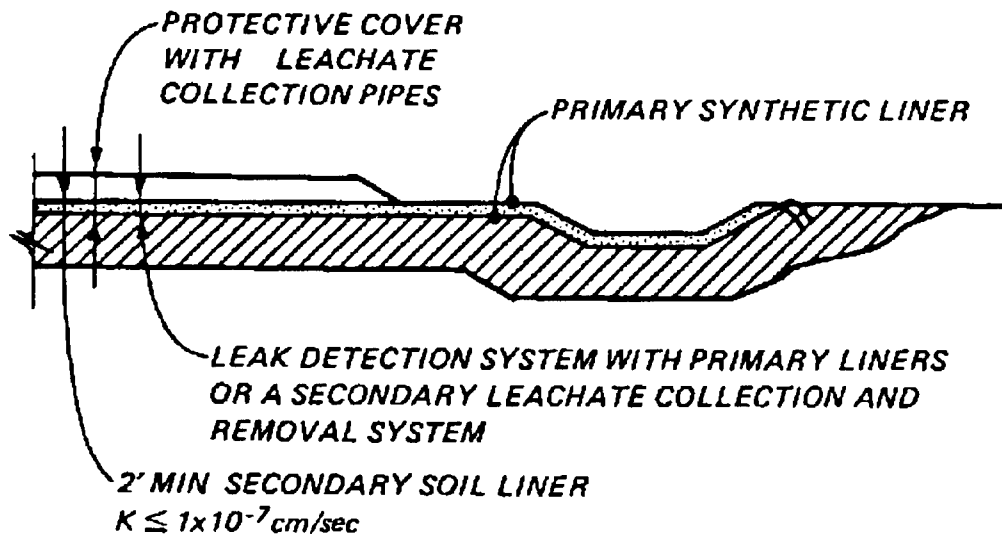

DOUBLE LINER SYSTEM

Figure 3-2. Base Liner Details for Waste Piles

adequate containment of waste should be an important consideration in initial design of a waste pile.

(2) Surface impoundments. Surface impoundments include any facility or part of a facility which is a natural topographic depression, man-made excavation, or diked area. They may be formed primarily of earthen materials or man-made materials, and designed to hold an accumulation of liquid wastes or wastes containing free liquids. Examples of surface impoundments are holding, storage, settling, and aeration pits, ponds, and lagoons. Surface impoundments are used for the storage, evaporation, and treatment of bulk aqueous wastes.

(a) Mixing of wastes is inherent in a surface impoundment. Incompatible wastes should not be placed in the same impoundment. The potential dangers from the mixing of incompatible wastes include extreme heat, fire, explosion, violent reaction, production of toxic mists, fumes, dusts, or gases. Some examples of potentially incompatible wastes are presented in Table 3-3.

(b) Surface impoundments should be located in a hydrogeologic setting that limits vertical and horizontal hydraulic continuity with ground water. The hydraulic head formed in the impoundment provides for a high potential for liquid seepage and subsurface migration. As with waste piles, surface impoundments may require the use of liners, leachate collection and removal, and runoff and runoff controls. An example detailing base liners for surface impoundments is shown in Figure 3-3.

(c) Surface impoundments must be inspected during their operating life. These inspections should include monitoring to ensure that liquids do not rise into the freeboard (prevention of overtopping), inspecting containment berms for signs of leakage or erosion, and periodic sampling of the impounded wastes for selected chemical parameters.

(3) Removal methods.

(a) Removal methods for settled residues and contaminated soil include removal of the sediment as a slurry by hydraulic dredging, excavation of the sediments with a jet of high-pressure water or air, vacuum transport of powdery sediments, excavation of hard solidified sediments by either dragline, front-end loader, or bulldozer.

(b) The major operation at an impoundment involves the "removal" of the liquid waste. Table 3-4 summarizes liquid waste removal methodologies.

(c) In addition to the requirement of a single liner with ground-water monitoring wells or a double liner with a leak detection system, other design elements include prevention of overtopping the sides of the impoundment and construction specifications that ensure the structural integrity of the dikes.

(d) Closure options include the removal or decontamination of all wastes, waste residues, system components, subsoils, structures, and equipment or the removal of the liquid waste and solidification of the remaining waste.

Table 3-3. Examples of Potentially Incompatible Wastes

Group A chemicals	Mixed with	Group B chemicals	May have	Potential consequence
<p>1-A</p> <p>Acetylene sludge Alkaline caustic liquids Alkaline cleaner Alkaline corrosive liquids Alkaline corrosive battery fluid Caustic wastewater Lime sludge and other corrosive alkalis Lime wastewater Lime and water Spent caustic</p>		<p>1-B</p> <p>Acid sludge Acid and water Battery acid Chemical cleaners Electrolyte, acid Etching acid liquid or solvent Pickling liquor and other corrosive acids Spent acid Spent mixed acid Spent sulfuric acid</p>		Heat generation; violent reaction
<p>2-A</p> <p>Aluminum Beryllium Calcium Lithium Magnesium Potassium Sodium Zinc powder Other reactive metals and metal hydrides</p>		<p>2-B</p> <p>Any waste in Group 1-A or 1-B</p>		Fire or explosion; generation of flammable hydrogen gas
<p>3-A</p> <p>Alcohols Water</p>		<p>3-B</p> <p>Any concentrated waste in Group 1-A or 1-B Calcium Lithium Metal hydrides Potassium SO₂, Cl₂, SOCl₂, PCl₃, CH₃, SiCl₃ Other water-reactive waste</p>		Fire, explosion, or heat generation; generation of flammable or toxic gases
<p>4-A</p> <p>Alcohols Aldehydes Halogenated hydrocarbons Nitrated hydrocarbons Unsaturated hydrocarbons Other reactive organic compounds and solvents</p>		<p>4-B</p> <p>Concentrated Group 1-A or 1-B wastes Group 2-A wastes</p>		Fire, explosion, or violent reaction
<p>5-A</p> <p>Spent cyanide and sulfide solutions</p>		<p>5-B</p> <p>Group 1-B wastes</p>		Generation of toxic hydrogen cyanide or hydrogen sulfide gas

(Continued)

Table 3-3. (Concluded)

Group A chemicals	Mixed with	Group B chemicals	May have	Potential consequence
<p>6-A</p> <p>Chlorates Chlorine Chlorites Chromic acid Hypo-chlorites Nitrates Nitric acid, fuming Perchlorates Permanganates Peroxides Other strong oxidizers</p>		<p>6-B</p> <p>Acetic acid and other organic acids Concentrated mineral acids Group 2-A wastes Group 4-A wastes Other flammable and combustible wastes</p>		<p>Fire, explosion, or violent reaction</p>

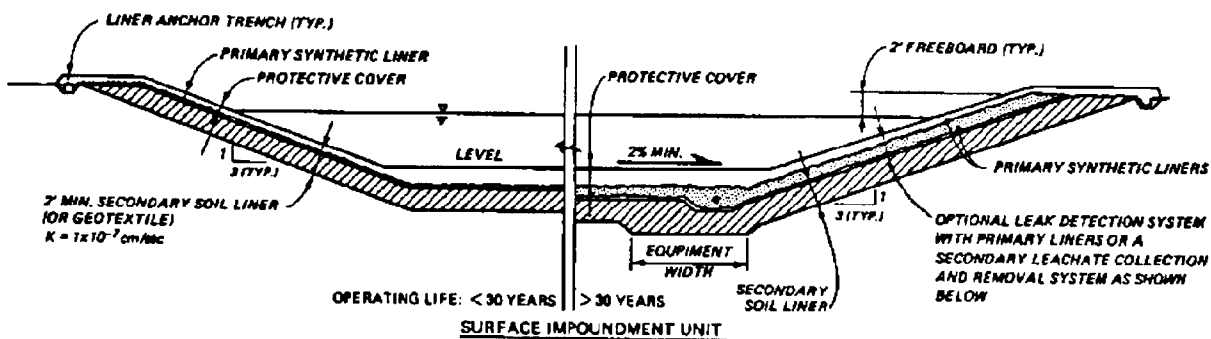

Figure 3-3. Base Liner Details for Surface Impoundments

Solidification also requires the placement of a final cover and ground-water monitoring to ensure that stabilization and capping operations were successful.

(4) Tanks. Tanks are stationary devices designed to contain an accumulation of hazardous waste and are constructed primarily of nonearthen materials (e.g. , wood, concrete, steel, plastic) which provide structural support. Tanks should be designed to be strong enough to ensure against collapse or rupture. Closed tanks should be vented or have some means to control the pressure. Tanks should be compatible or have a liner that is compatible with the stored waste. Incompatible wastes should not be stored in the same tank.

c. Summary of Current Regulations. References to EPA advisories and regulations for hazardous waste storage, treatment, or disposal are listed below.

<u>Containment Method</u>	<u>Regulations</u>
Landfills, surface impoundments, waste piles, and land treatment units	Federal Register, Vol 47, No. 143
Containers and tanks	Federal Register, Vol 46, Page 2867
Standards for waste containers	40 CFR Part 264, Subpart I, Sections 264.170-264.178; and Subpart J, Sections 264.190-264.199
Standards for surface impoundments	40 CFR Part 264, Subpart K
Standards for waste piles	40 CFR Part 264, Subpart L and Subpart F

Table 3-4. Liquid Waste Removal Methods for Surface Impoundments

Method	Description
Decanting	Liquids within or ponded on the surface of the impoundment can be removed by gravity flow or pumping to a treatment facility if there is not a large percentage of settleable solids.
Pumping and settling	Liquids or slurries composed of suspended or partially suspended solids can be removed by pumping into a lined settling pond and then decanting. Sludges are disposed in a dry state, and either returned to the impoundment or disposed in another contained site.
Solar drying	Liquids are removed by evaporation; sludges remaining after evaporation are left in the impoundment or disposed in another contained site. Note that volatile organics should not be handled in this manner.
Chemical neutralization	Aqueous waste with low levels of hazardous constituents frequently lends itself to chemical neutralization and subsequent normal discharge under NPDES permit requirements
Infiltration	Certain aqueous waste can be handled by infiltration through soil, provided that the hazardous substances are removed by either soil attenuation or underdrain collection of the solute. Collected solutes are usually treated.
Process reuse	Some aqueous waste can be recycled in the manufacturing process a number of times until the contaminants are at a level requiring disposal by one of the methods previously mentioned. Reuse does not dispose of the waste but can significantly reduce the quantities to be disposed.
Absorbent addition	Materials can be added to aqueous impounded wastes to absorb free liquids. Absorbents include sawdust; wood shavings; agricultural wastes such as straw, rice, and peanut hulls; and commercially available sorbents.

3-6. Tank Cleaning and Demolition. Tank cleaning and demolition procedures are site specific and depend largely on the nature of tank contents. A major consideration is whether the contents are ignitable or explosive. If possible, the contents of the tank should be removed by pumping or draining, then the tank can be decontaminated and demolished. Provisions must be made for treatment and disposal of contaminated washwaters.

a. Tanks Containing Sludges. If the sludge cannot be removed, water should be pumped into the tank to completely cover the sludge and the contents

of the tank should be blanketed with nitrogen. The tank head space should then be checked with an explosion meter to ensure a safe working environment before proceeding. Then the top area of the tank should be cut using an oxyacetylene torch. Explosion meter checks should be made after each cut to ensure that no explosive gases are collecting during cutting operations. Successive "slices" of the tank should be removed until there is sufficient working room to remove the contents of the tank. Adequate fire protection should be available onsite along with a paramedic unit during tank demolition activities if there is a risk of fire or explosion.

b. Tanks Containing Liquids. Once the tank contents have been removed by pumping or draining, the tank can be decontaminated. Depending upon the contents, water and/or organic solvents may be used. The final decontamination process should be water flushing if the tank contained ignitable or explosive waste material. Chemical emulsifiers may be used to remove hydrophobic organics. Before proceeding with tank demolition, explosion meter checks should be taken. If an explosive hazard exists, the tank should be blanketed with water and nitrogen before being cut. Again, explosive checks should be made after each cut while the tank is cut away in "slices." Fire protection personnel and paramedics should be present any time there is the danger of fire or explosion.

3-7. Lagoon Management. Existing lagoons, ponds, and disposal pits have the potential to contaminate surface water, ground water, soil, and the surrounding air. Precipitation (rainwater and surface runoff) may increase the volume of the contaminated waste, increasing the potential for ground- and surface-water contamination, and increasing total cleanup costs. Background information on geology, hydrology, soils, and the character of the waste itself is most important in determining the potential for leachate generation and its vertical and horizontal migration through the ground-water system.

a. Management Plans. The contents of a lagoon may be contained, treated, or disposed of onsite or may be removed from the lagoons to an offsite treatment or disposal facility.

(1) Onsite remedial actions.

(a) Onsite management plans may include a no-action alternative with no treatment for the waste and establishment of a monitoring program to detect any surface or subsurface migration of contaminants. This option may be appropriate if it has been determined that the underlying aquifer is unusable and there is no imminent danger of contaminating nearby surface waters or residential wells. Long-term monitoring can be very expensive and the potential liability of the impounded waste may not decrease over time.

(b) The wastes may be pumped to an onsite treatment facility. Liquids may be pumped with one or more of many available pumps. However, the compatibility of the liquid waste with the pump's materials that come in contact with the liquid should be considered to avoid equipment failures. Sludges and contaminated sediments at the bottom of the lagoon may or may not require dredging to remove them from the lagoon depending on viscosity. Onsite treatment of the liquid waste may be accomplished through physical,

chemical, and/or biological methods. Treatment systems are further discussed in Chapter 4.

(c) The wastes may also be treated in situ using one of many options. These options include solidification, stabilization, or encapsulation. When preparing the contract for a project with in-situ treatment, a pilot-scale demonstration using the actual construction equipment proposed for the job should be required. Obtaining a sufficient mixing action with sludges using heavy construction equipment can be a difficult task with low quality control at hazardous waste impoundments.

(d) If the waste is left in place after being treated, it should be isolated from surface and ground water. Capping and surface water diversion can prevent most leachate generation. Ground water can be controlled with the use of subsurface barriers or by ground-water pumping.

(2) Offsite remedial actions. The contents of a lagoon may also be removed and transported to an offsite facility for treatment or disposal. Treatment processes may be applied to the waste during the removal operation depending on the treatment/disposal option being used. The additional handling and transportation problems should be considered. Also, once the liquid contents of the lagoon have been removed, the remaining sludge and underlying contaminated soil may have to be removed and treated at the same offsite facility.

3-8. Excavation of Landfills and Contaminated Soils. Excavation is a common technique used to move solid and thickened sludge materials. Where offsite treatment methods are to be used, excavation and transportation of the waste material will be required.

a. Design and Construction Considerations. Important factors that should be considered before excavation of a refuse site can begin are listed below.

(1) Density of solid waste in a landfill. Density is dependent on the composition of the waste and the degree of compaction achieved. Average densities of landfilled wastes generally range from 474 to 593 kg/m³ (800 to 1,000 lb/yd³) with moderate compaction.

(2) Settlement of the fill. As a result of decomposition of the waste and the addition of new waste material, settling of fine particles into voids between solid matter can occur.

(3) Bearing capacity of the fill. Bearing capacity is the ability to support foundations (and heavy equipment). Average values ranging from 23.9 KPa to 38.3 KPa (500 to 800 lb/ft²) have been reported.

(4) Decomposition rate of waste. Most of the materials present in a refuse site will decompose. Decomposition of organic waste under anaerobic conditions predominantly occurs at the base of the site and can generate highly corrosive organic acids and toxic gases such as methane or hydrogen sulfide.

(5) Packaging of waste. Packaging of waste in barrels and tanks may present additional removal problems.

b. Mechanical Methods. Excavation of a landfill may be achieved by mechanical means. Typical excavation equipment includes draglines, backhoes, and clamshells.

(1) The dragline.

(a) A dragline excavator is a crane unit with a drag bucket connected by cable to the boom. The bucket is filled by scraping it along the top layer of soil toward the machine by a drag cable. The dragline can operate below and beyond the end of the boom.

(b) Maximum digging depth of a dragline is approximately equal to half the length of the boom, while digging reach is slightly greater than the length of the boom. Draglines are very suitable for excavating large land areas with loosely compacted soil.

(2) The backhoe.

(a) The backhoe unit is a boom or dipper stick with a hoe dipper attached to the outer end. The unit may be mounted on either crane-type or tractor equipment.

(b) The largest backhoe will dig to a maximum depth of about 13.7 m (45 feet). Deeper digging depth can be achieved by attaching long arms to one-piece booms or by adjusting the boom angle on two-piece booms.

(c) Some hydraulic backhoes having booms that can be extended up to 30.5 m (100 feet) or retracted for close work can be used to excavate, backfill, and grade.

(3) The clamshell. To achieve deeper digging depth, clamshell equipment must be used. A clamshell bucket is attached to a crane by cables. A clamshell excavator can reach digging depths greater than 30.5 m (100 feet).

c. Advantages and Disadvantages. Advantages and disadvantages of the excavation technique using dragline and backhoe are listed below.

<u>Advantages</u>	<u>Disadvantages</u>
	<u>Dragline</u>
Readily available	Difficult to spot bucket for scraping and dumping
Applicable for excavation of large area	Cannot backfill or compact

(Continued)

<u>Advantages</u>	<u>Disadvantages</u>
Easy to operate	Not applicable for digging depth more than 9.1 m (30 ft)
<u>Backhoe</u>	
Readily available	Not applicable for digging depth over 9.1 m (30 ft)
Easy to control the bucket and thus control width and depth of excavation	Cannot be extended beyond 30.5 m (100 ft)
Can excavate hard and compacted material	
More powerful digging action than dragline	
Can be used to backfill and compact	

3-9. Removal of Contaminated Sediments.

a. Background.

(1) Uncontrolled waste disposal sites may directly or indirectly contaminate bottom sediments deposited in streams, creeks, rivers, ponds, lakes, estuaries, and other bodies of water. Sediment contamination by waste disposal sites may occur along several different pathways. Contaminated soil may be eroded from the surface of hazardous waste disposal sites by natural run-off and subsequently deposited in nearby watercourses or sediment basins constructed downslope of the site. Also, existing sediments along stream and river bottoms may adsorb chemical pollutants that have been washed into the watercourse from disposal areas within the drainage basin. Similarly, contaminated ground water may drain to surface watercourses and the transported pollutants may settle into, or chemically bind with, bottom sediments. Another possible source of sediment contamination is direct leakage or spills of hazardous liquids from damaged or mishandled waste containers; spilled chemicals that are heavier and denser than water will sink to the bottom of natural waters, coating and mixing with sediments.

(2) Dredging serves the same basic function as mechanical excavation: removal of hazardous waste materials from improperly constructed or sited disposal sites for offsite treatment or disposal. Several types of dredges are commonly used, including hydraulic, pneumatic, and mechanical dredges. Dredged material management includes techniques for drying, physical processing, chemical treatment, and disposal. Plans to remove and treat contaminated sediments must be designed and implemented on a site-specific basis. An evaluation of the need for placing fill or dredged materials in waters of the United States or by alternate routes must be made in accordance with the 404 (b)(1) Guidelines (40 CFR Part 230). Discharge of fill or dredged materials will not be permitted if a practicable alternative having less adverse environmental impact exists.

(3) A knowledge of the physical properties and distribution of contaminated sediments is essential in selecting a dredging technique and in planning the dredging operation. Information on grain size, bed thickness, and source and rate of sediment deposition is particularly useful. Such information can be obtained through a program of bottom sampling or core sampling of the affected sediment.

b. Description and Application of Dredging Techniques.

(1) Hydraulic dredging.

(a) Available techniques for hydraulic dredging of surface impoundments include centrifugal pumping systems and portable hydraulic pipeline dredges. Centrifugal pumping systems utilize specially designed centrifugal pumps that chop and cut heavy, viscous materials as pump suction occurs. The special chopper impeller devices within these pumps allow high-volume handling of heavy sludges and other solids mixtures without the use of separate augers or cutters.

(b) Cutterhead pipeline dredges are widely used in the United States; they are the basic tool of the private dredging industry. Cutterhead dredges loosen and pick up bottom material and water, and discharge the mixture through a float-supported pipeline to offsite treatment or disposal areas. They are generally from 7.6 to 18.3 m (25 to 60 feet) in length, with pump discharge diameters from 152 to 508 mm (6 to 20 inches). There are two basic types of portable cutterhead dredges: the standard basket cutters (Figure 3-4) and the smaller specialty dredges that use a horizontal auger assembly and move only by cable and winch.

(c) For dredging surface impoundments deeper than 6.1 m (20 feet), the standard cutterhead dredge (Figure 3-5) is required. This type of dredge moves forward by pivoting about on two rear-mounted spuds (heavy vertical posts), which are alternately anchored and raised. The swing is controlled by winches pulling on cables anchored forward of the dredge (Figure 3-6). The rotating cutter on the end of the dredge ladder physically excavates material ranging from light silts to consolidated sediments or sludge, cutting a channel of variable width (depending on ladder length) as the dredge advances. For deep surface impoundments containing only soft, unconsolidated bottom materials, a variation of the standard cutterhead dredge--the suction pipeline dredge--can be used to dredge the impoundment. Suction dredges are not equipped with cutterheads, or they simply operate without cutterhead rotation; they merely suck the material off the bottom and, like most dredges, discharge the mixture through a stern-mounted pipeline leading to a disposal area.

(2) Low-turbidity hydraulic dredging.

(a) Low-turbidity dredging is any hydraulic dredging operation that uses special equipment (dredge vessels, pumps) or techniques to minimize the

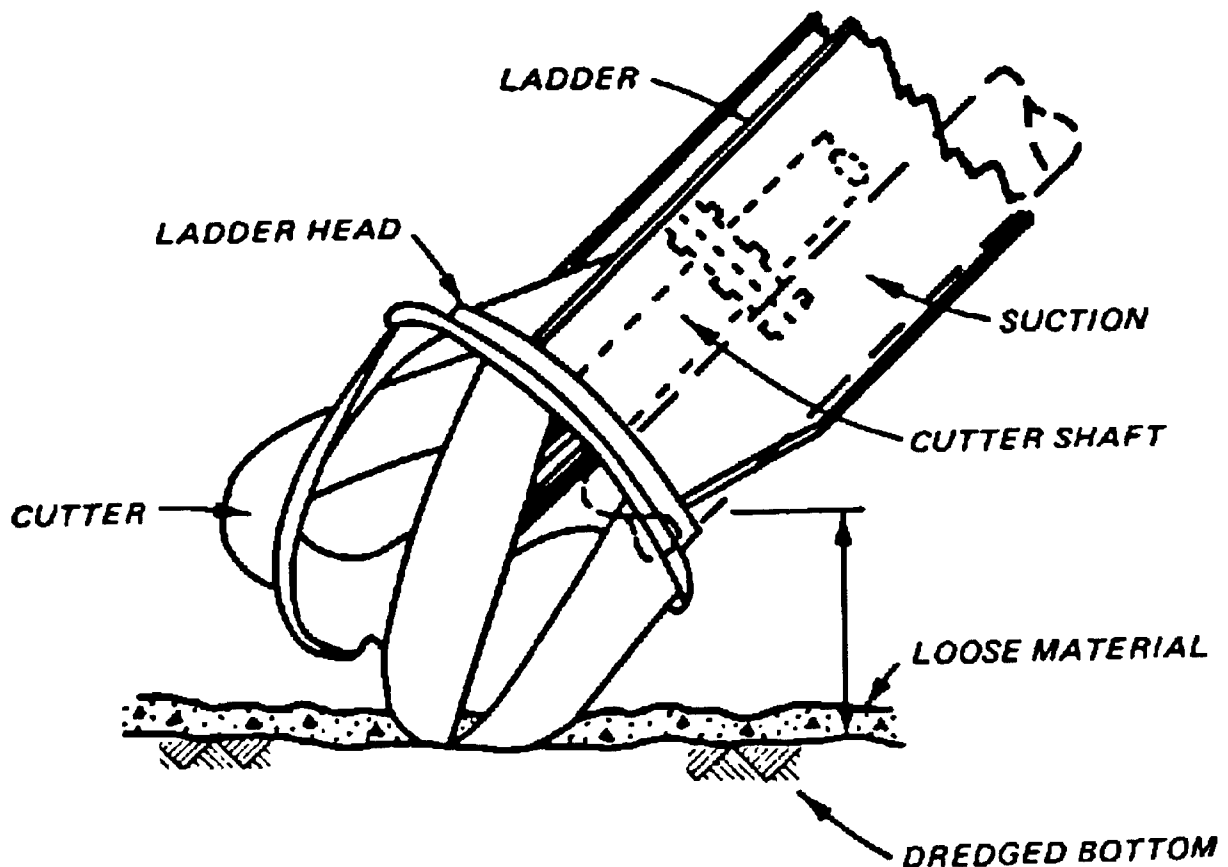

Figure 3-4. Standard Cutter Assembly, Spiral Basket Cutter

resuspension of bottom materials and subsequent turbidity that may occur during the operation. Conventional hydraulic dredging may cause excessive agitation and resuspension of contaminated bottom materials, which decreases sediment removal efficiency and which may lead to downstream transport of contaminated materials, thereby exacerbating the original pollution. Low-turbidity hydraulic dredging systems include small specialty dredge vessels, suction dredging systems, and conventional cutterhead dredges that are modified using special equipment or techniques for turbidity control.

(b) The Mud Cat dredge utilizes a submerged pump mounted directly behind a horizontal auger to handle highly viscous chemical sludges or thick, muddy sediments. The Mud Cat MC-915 (Figure 3-7) can remove sediment in a 2.7 m (9-foot-wide) swath, 457 mm (18 inches) deep, at depths as great as 4.6 m (15 feet) and as shallow as 508 mm (21 inches). The horizontal auger can be tilted left and right to a 45-degree angle to accommodate sloping sides of impoundments. With an auger wheel attachment, the Mud Cat can dredge in lined impoundments without damaging the liner. Two people are required to operate the 9.1 m (30-foot-long) machine, which moves by winching itself in either direction along a taut, fixed cable at average operating speeds of

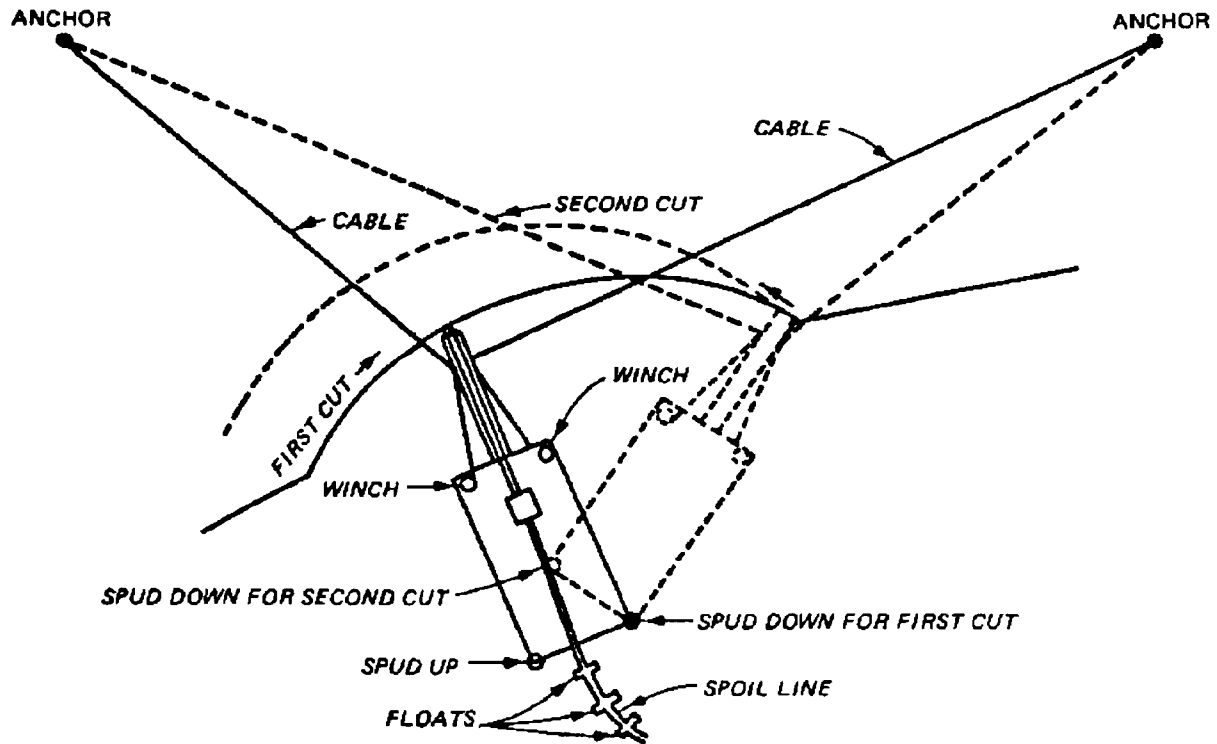

Figure 3-5. Standard Cutterhead Dredge Operation

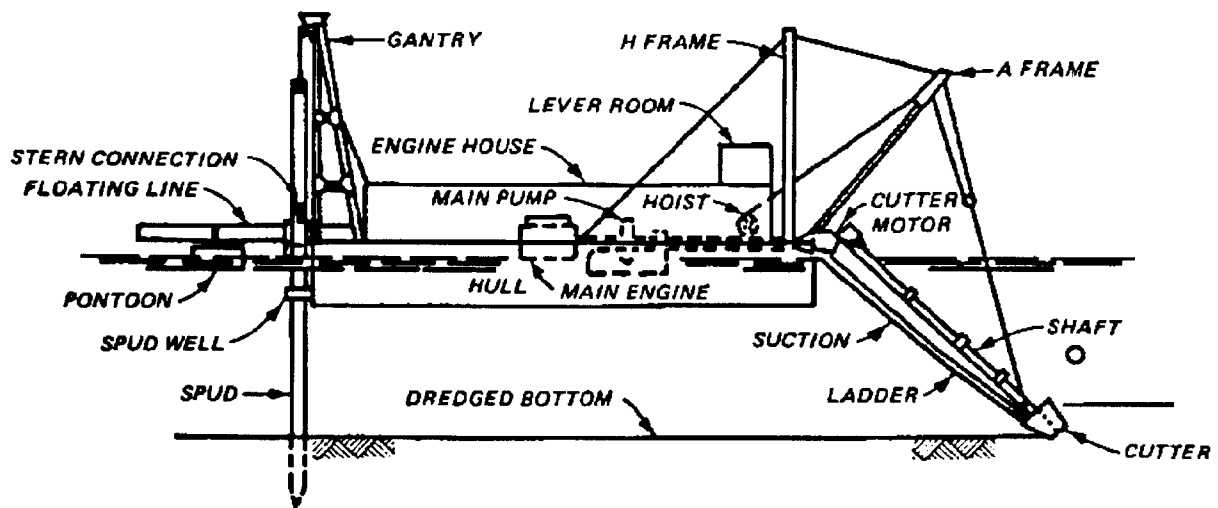

Figure 3-6. Standard Cutterhead Dredge Vessel

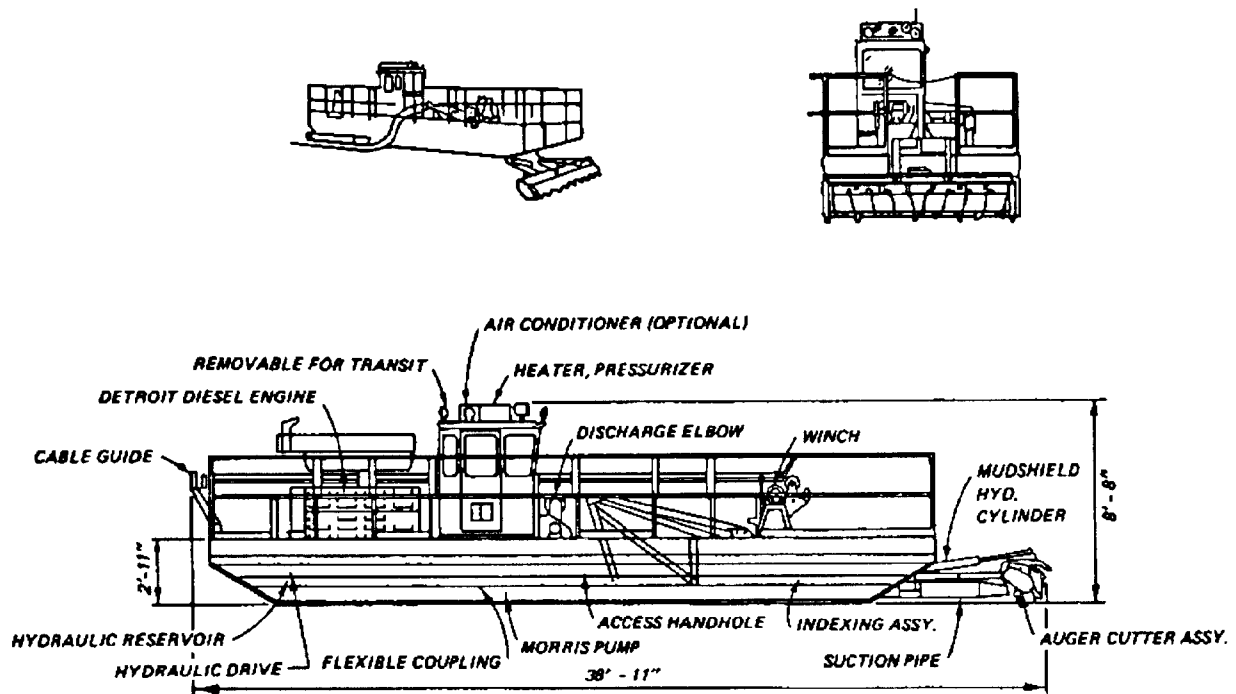

Figure 3-7. Views of the Mud Cat MC-915 Dredge

41 to 61 mm/s (8 to 12 feet per minute). The Mud Cat has a retractable mudshield, which surrounds the cutter head, entrapping suspended material, increasing suction efficiency, and minimizing turbidity. The Mud Cat can discharge approximately 95 ℓ /s or 5.7 m^3 /min (1,500 gallons per minute) of slurry with 10 to 30 percent solids through an 203 mm (8-inch) pipeline and, depending on site-specific conditions, can remove up to 92 m^3 /hr (120 cubic yards per hour) of solids. The Mud Cat dredge was 95 to 99 percent efficient in removing sediments and simulated hazardous materials from impoundment bottoms in field tests conducted for the EPA.

(c) A Japanese suction dredge, the "Clean Up" (Figure 3-8), uses a hydraulically driven, ladder-mounted submerged centrifugal pump to "vacuum" muddy bottom sediments (fine grained; high water content) from depths as great as 22.9 m (75 feet), with very low turbidity. This system can pump very dense mixtures 40 to 50 percent solids by volume at constant flow rates as great as 526 ℓ /s or 1895 m^3 /hr (500,000 gallons per hour), removing up to 688.5 m^3 (900 cubic yards) of sediment per hour. A dredge vessel equipped with this pumping system may be used to remove contaminated sediments from large rivers or harbors in depths as shallow as 4.9 m (16 feet), with minimal pollution of the surrounding environment from dredgegenerated turbidity.

(d) Another Japanese dredging system for removal of high-density sludges is called the "oozer pump" which may have applications in very deep bodies of water such as large rivers or harbors. This system utilizes vacuum

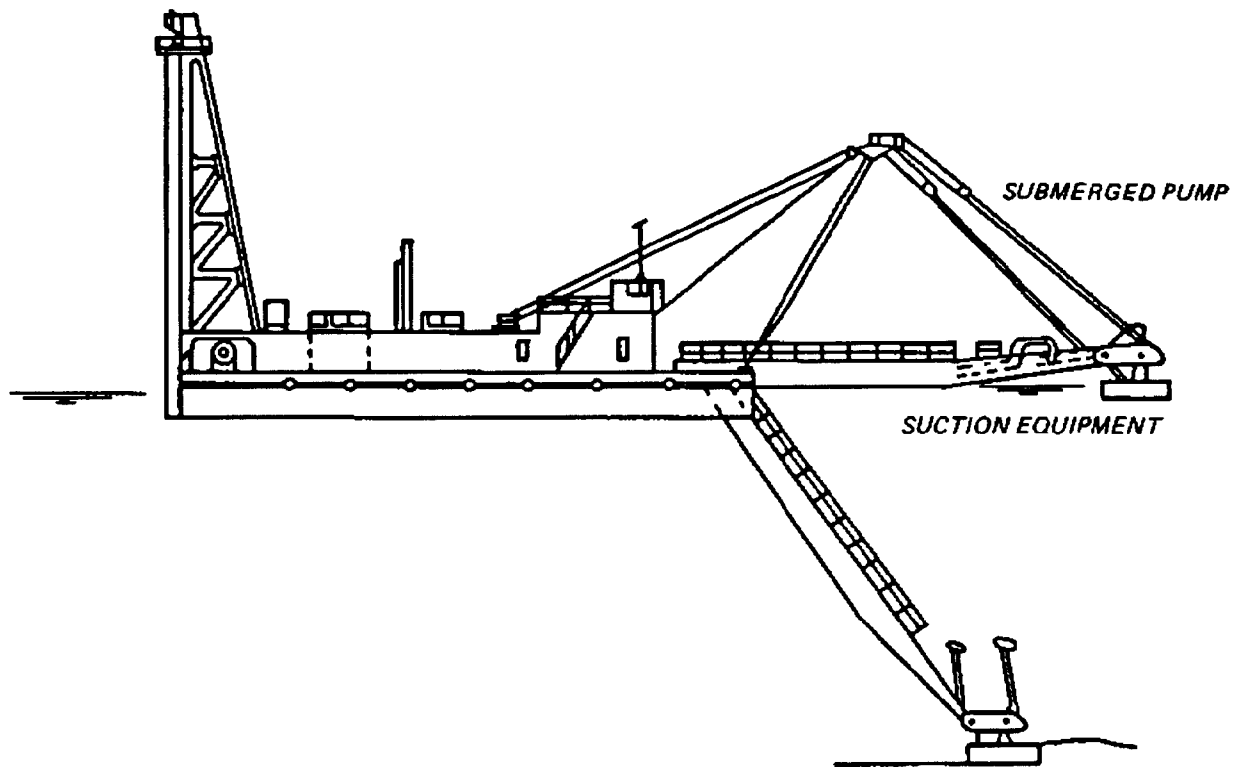

Figure 3-8. The Japanese Suction Dredge "Clean Up"

suction and air compression to efficiently remove muddy sediments (silt and clay) and sludges with low turbidity.

(e) A typical centrifugal pumps system (Figure 3-9) is 2.4 m (8 feet) wide, 4.3 m (14 feet) long, approximately 2.1 m (7 feet) high, and weighs about 2730 kg (3 tons); its 75 kw (100-horsepower) motor can pump up to 76 L/S or 4.5 m³/min (1,200 gallons per minute) of 15 to 20 percent solids from depths up to 4.6 m (15 feet).

(f) Other specialty low turbidity dredges include the bucket-wheel-type dredge, recently developed by Ellicott Machine Corporation, that is capable of digging highly consolidated material and has the ability to control the solids content in the slurry stream. The Delta Dredge and Pump Corporation has also developed a small portable unit that has high solids capabilities. The system uses a submerged 305 mm (12-inch) pump coupled with two counter-rotating, low-speed, reversible cutters.

(3) Mechanical dredging.

(a) Mechanical dredging of contaminated sediments should be considered under conditions of low, shallow flow. Dredging should be used in conjunction with stream diversion techniques to hydraulically isolate the area of sediment

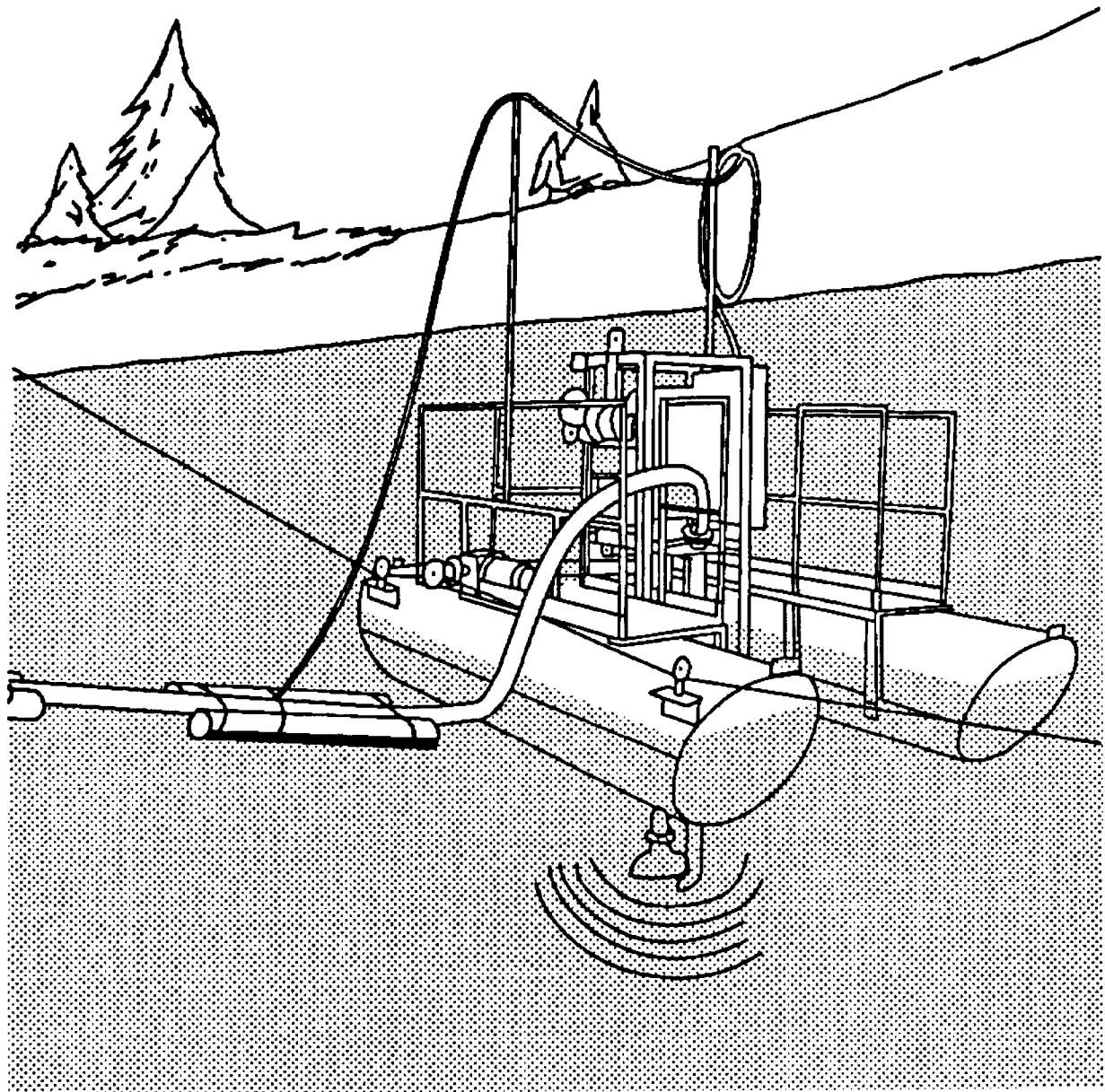

Figure 3-9. Portable Centrifugal Pump System for Lagoon Dredging

removal. Under any other conditions mechanical excavation with draglines, clamshells, or backhoes may create excessive turbidity and cause uncontrolled transport of contaminated sediments further downstream. Stream diversions with temporary cofferdams can be followed by dewatering and mechanical dredging operation for streams, creeks, or small rivers. Mechanical excavation can also be used to remove contaminated sediments that have been eroded from disposal sites during major storms and deposited in floodplains or along riverbanks above the level of base flow.

(b) For streams and rivers that are relatively shallow and whose flow velocity is relatively low, backhoes, draglines or clamshells can be used to excavate areas of the streambed where sediments are contaminated. The excavated sediments can be loaded directly onto haul vehicles for transport to a predesignated disposal area; however, the excavated material must be sufficiently drained and dried before transport. Backhoe and dragline operation requires a stable base from which to work. For these reasons, direct mechanical dredging of contaminated sediments in streams is not recommended except for small streams with stable banks, slow and shallow flow, and underwater structures, and where contaminated sediments are relatively consolidated and easily drained.

(c) A more efficient mechanical dredging operation with broader application involves stream or river diversion with cofferdams, followed by dewatering and excavation of contaminated sediments. Such an operation may prove quite costly; however, there is little chance of stirring up sediments and creating downstream contamination. Efficiency of sediment removal is much greater by this method than by instream mechanical dredging without diversion of flow.

(d) Sheet-pile cofferdams may be installed in pairs across streams to temporarily isolate areas of contaminated sediment deposition and allow access for dewatering and excavation (Figure 3-10). Alternatively, a single curved or rectangular cofferdam may be constructed to isolate an area along one bank of the stream or river (Figure 3-11); this method only partially restricts natural flow and does not necessitate construction of a temporary diversion (bypass) channel to convey entire flow around the area of excavation, as the first method does.

c. Design and Construction Considerations of Dredging Techniques.

(1) The selection of dredging equipment or pumping systems for the removal of contaminated materials will depend largely on manufacturer specifications for a given dredge vessel or pump system. Important selection criteria that will vary from site to site are:

- (a) Surface area and maximum depth of the impoundment.
- (b) Total volume of material to be dredged.
- (c) Physical and chemical nature of sediments.
- (d) Pumping distance and terminal elevation (total head).
- (e) Presence of bottom liner in impoundment.
- (f) Type and amount of aquatic vegetation.
- (g) Power source for dredge.
- (h) Ease of access and size and weight limits of roads.

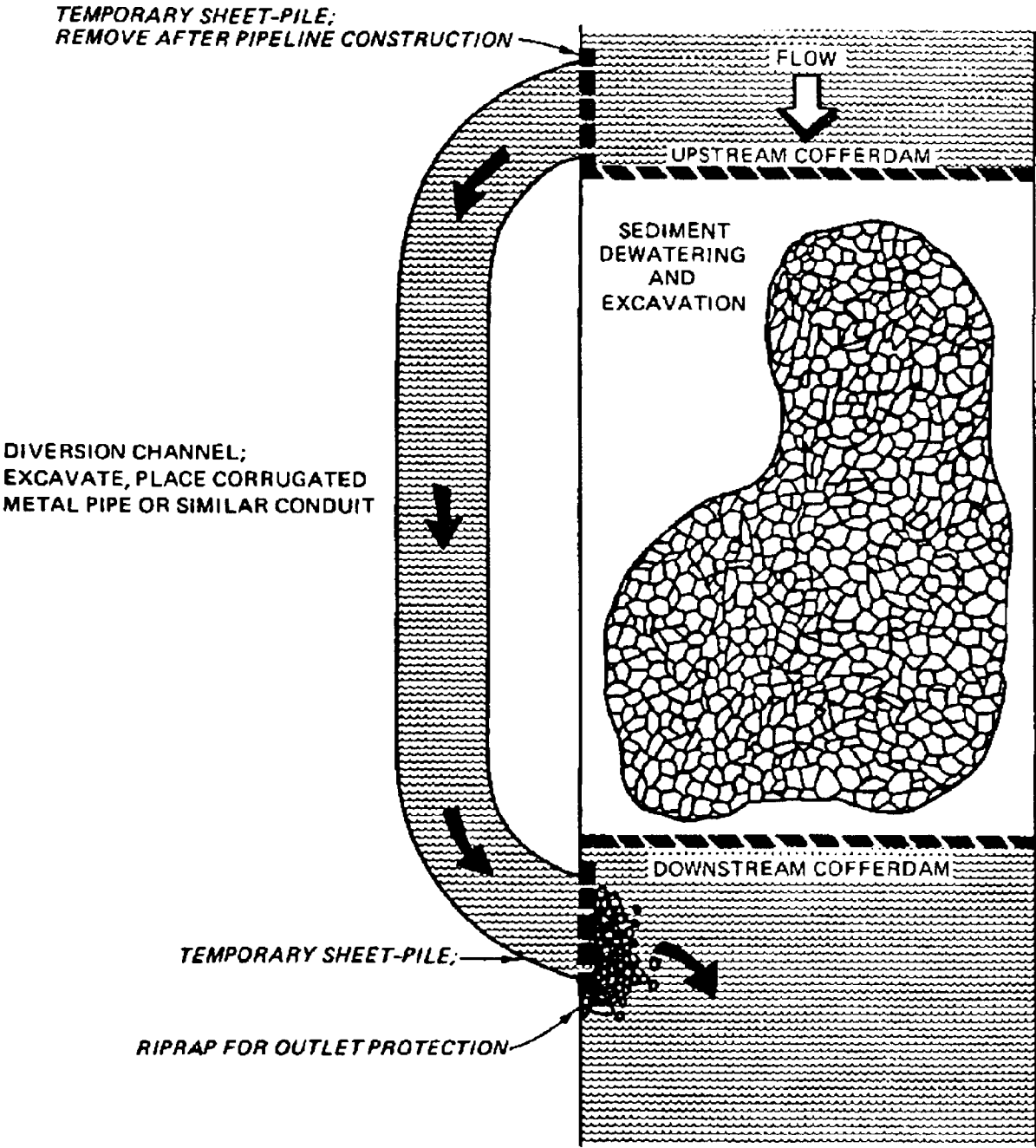

Figure 3-10. Streamflow Diversion for Sediment Excavation Using Two Cofferdams and Diversion Channel

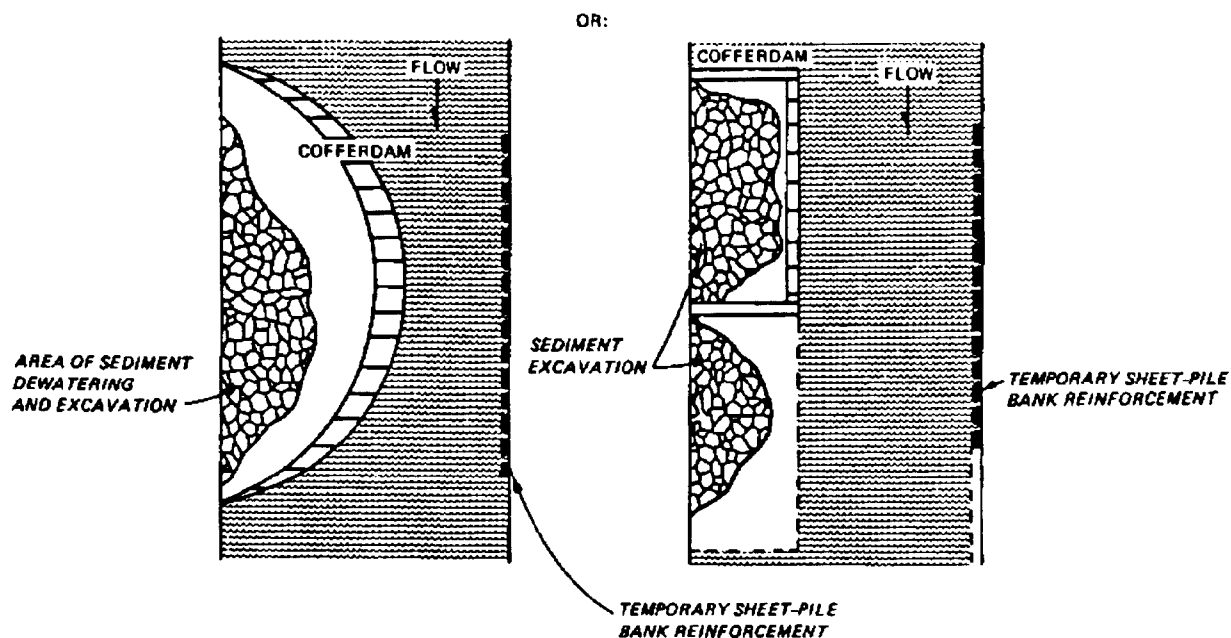

Figure 3-11. Streamflow Diversion for Sediment Excavation Using Single Cofferdam (Source: EPA 1982)

(2) All criteria must be considered before selection of a pumping system or dredge vessel of the appropriate size, efficiency, and overall capabilities can be made. The centrifugal pumps used in pumping systems or dredge vessels have a rated discharge capacity based on maximum pump speed (in revolutions per minute, rpm) and a given head against which they are pumping. The total head against which pumps must work is affected by the depth of dredging, the distance over which the material is pumped, and the terminal elevation of the discharge pipeline in relation to the water level within the impoundment.

(3) When preparing dredging contracts for contaminated sediment removal where turbidity control is essential, contract provisions should specify the use of special low-turbidity dredge vessels or auxiliary equipment and techniques designed to minimize turbidity generation. The bidder should be made to specify minimum sediment removal volumes and maximum allowable turbidity levels in the downstream environment to ensure an effective dredging operation.

(4) During dredging of stream or river sediments, agitation of the bed deposits during excavation may generate a floating scum of contaminated debris on the water surface, particularly if the chemical contaminant is oily or greasy in nature. The installation of a silt curtain downstream of the dredging site will function to trap any contaminated debris so generated; the debris can then be collected through skimming. Similarly, silt curtains can be employed to minimize downstream transport of contaminated sediments. A schematic of a silt curtain is shown in Figure 3-12. It is constructed of

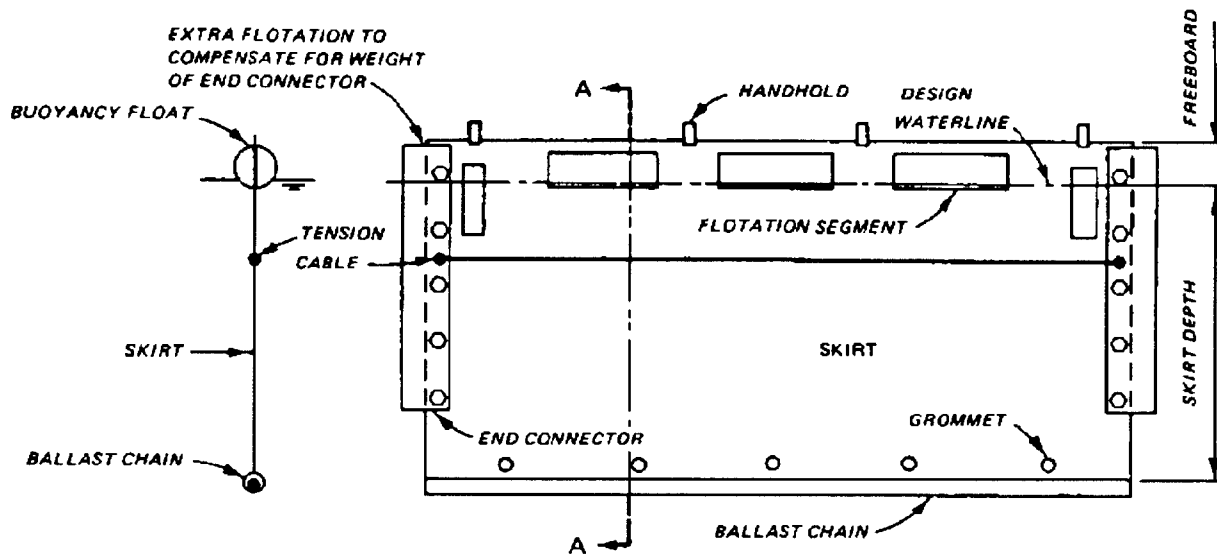

Figure 3-12. Construction of a Typical Center Tension Silt Curtain Section

nylon-reinforced polyvinyl chloride and manufactured in 27.4 m (90-foot) sections that can be joined together in the field to provide the specified length. Silt curtains are usually employed in U-shaped or circular configurations, as shown in Figure 3-13. Silt curtains are not recommended for flow velocities greater than 0.46 m/s (1.5 feet per second).

(5) Sheet-pile cofferdams are generally constructed of black steel sheeting, in thickness from 5.6 to 2.7 mm (5 to 12 gage) and in lengths from 1.2 to 12.2 m (4 to 40 feet). For additional corrosion protection, galvanized or aluminized coatings are available. Cofferdams may be either single walled or cellular, and can be earth-filled in sections. Single-wall cofferdams may be strengthened by an earth fill on both sides. Cellular cofferdams consist of circular sheet-pile cells filled with earth, generally a mixture of sand and clay. Single-wall sheet-pile cofferdams are most applicable for shallow water flows. For depths greater than 1.5 m (5 feet), cellular cofferdams are recommended.

(6) Mechanical excavation of dewatered, contaminated sediments can be accomplished with backhoes, draglines, or clamshells. Mechanical dredging output rates will vary depending on the size and mobility of the equipment, and on site-specific conditions such as available working area. Excavated sediments can be loaded directly into haul trucks onsite for transport to special disposal areas. Haul truck loading beds should be bottom sealed and covered with a tarpaulin or similar flexible cover to ensure that no sediments are lost during transport.

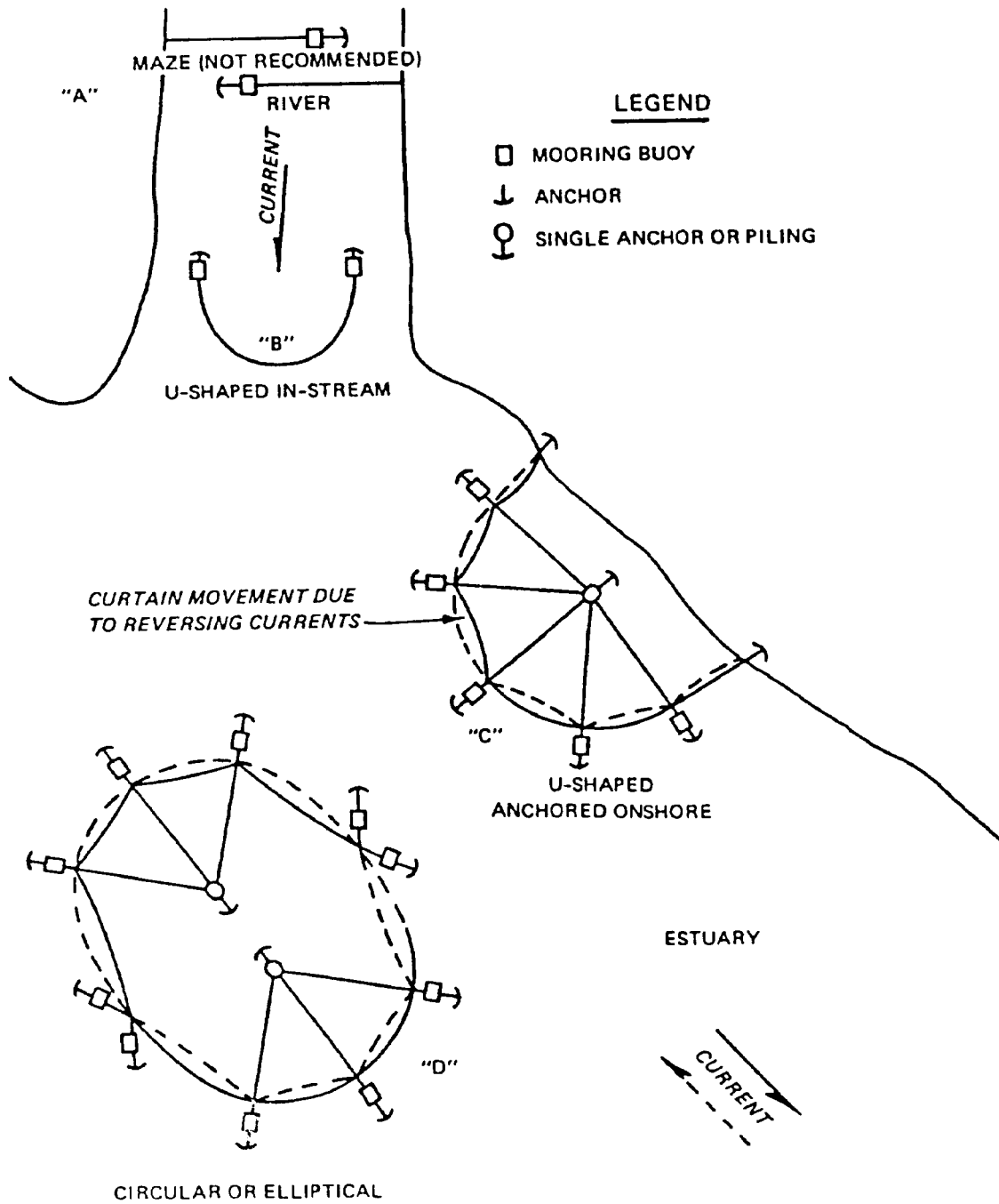

Figure 3-13. Typical Silt Curtain Deployment Configurations

d. Advantages and Disadvantages.

(1) The main disadvantage associated with hydraulic removal of materials from surface impoundments is the necessity of locating and/or constructing dewatering/disposal areas (or treatment facilities) within economical distances of the dredging site. Containment facilities must be able to handle large volumes of dredged material in a liquid slurry form, unless dewatering is performed prior to transport. Advantages and disadvantages of hydraulic dredging of surface impoundments are as follows:

<u>Advantages</u>	<u>Disadvantages</u>
Efficient removal of solids/water mixtures from impoundments	Necessitates locating dredge material management facilities (dewatering, disposal, treatment) nearby
Removes hazardous materials in readily processed form (slurry)	Necessitates high volume handling of solids/water mixtures
Suitable for removal of materials from surface impoundments in wide range of consistencies- -from free-flowing liquids to consolidated/solidified sludges	May require booster pumps for long-distance transport of dredged slurries
Utilizes well-established, widely available technology	Mobilization and demobilization may be time-consuming and costly
	Cannot remove large items (such as drums)

(2) The advantages and disadvantages of direct instream mechanical dredging are listed below:

<u>Advantages</u>	<u>Disadvantages</u>
May be cost-effective for slow, shallow streams or sediments in dry streambeds or floodplains	Generates excessive turbidity; may cause downstream transport of sediments
Also effective for small, isolated pools or ponds containing contained sediments	Only feasible for low, shallow flows with stable streambanks and consolidated sediments
Barge-mounted operations may be used for large rivers	May require special dewatering methods (clamshell) lift and drain over haul (trucks)
	Efficiency of removal generally poor
	Generally not recommended for handling contaminated sediments instream

(3) Cofferdam diversion streamflow, with subsequent dewatering and mechanical excavation of contaminated sediments, is addressed below.

<u>Advantages</u>	<u>Disadvantages</u>
High efficiency of removal; low turbidity	May be quite costly for deep, wide flows and sites requiring diversion pipeline
Involves well-established construction techniques	Not feasible for fast stream flows (greater than 0.61 in/s (2 feet per second))
Structures easily removed and transported	Not recommended for flows deeper than 3 m (10 feet)
Cost-effective for slow-flowing streams and rivers with favorable access (stable banks; open areas)	Sediment dewatering may be required
	Access for mechanical excavation equipment may be difficult
	May require large excavation and loading area
	Transportation costs may be excessive (remote areas)
	Geologic substrate may prevent sheet-pile drive

3-10. Decontamination of Structures. Decontamination of structures is a common requirement at sites where the uncontrolled release of hazardous substances has occurred. A variety of techniques are available for decontamination surfaces and structures.

a. Decontamination of Surfaces.

(1) Absorption is widely used in industrial settings to clean up chemical and other liquid spills and is most applicable immediately following liquid contaminant spills. Contaminants rapidly penetrate most surfaces, and absorbents act to contain them. Depending on the surface and time elapsed since the spill, further decontamination procedures may have to be employed.

(2) Acid etching of a contaminated surface is used to promote corrosion and removal of the surface layer. Muriatic acid (hydrochloric acid) is used to remove dirt and grime from brick building surfaces in urban areas and to clean metal parts (e.g., pickle liquors from metal finishing operations). The resulting contaminated debris is then neutralized. Thermal or chemical treatment of the removed material may be required to destroy the contaminant before disposal. Although this technique is not known to have been applied to chemically contaminated building surfaces, it is believed to have good potential.

(3) Bleaching formulations (usually strong oxidants) are applied to a contaminated surface, allowed to react with contaminants, and removed. Application usually occurs in conjunction with other decontamination efforts, such as the use of absorbents and/or water-washing. Bleach has been used as a decontaminant against mustard, G and V chemical agents, and (experimentally) organophosphorus pesticides.

(4) Drilling and spalling can remove up to 5 centimeters of contaminated surface material from concrete or similar materials by drilling holes 2.5 to 4 centimeters in diameter approximately 7.5 centimeters deep. The spalling tool bit is inserted into the hole and hydraulically spreads to spall off the contaminated concrete. The technique can achieve deeper penetration (removal) of surfaces than other surface-removal techniques, and it is good for large-scale applications. The treated surface is very rough and coarse, however, and may require resurfacing (i.e., capping with concrete). The drilling and spalling method has been used in the decommissioning of nuclear facilities.

(5) Dusting/vacuuming/wiping is simply the physical removal of hazardous dust and particles from building and equipment surfaces by common cleaning techniques. Variations include vacuuming with a commercial or industrial-type vacuum; dusting off surfaces such as ledges, sills, pipes, etc., with a moist cloth or wipe; and brushing or sweeping up hazardous debris. Dusting and vacuuming are applicable to all types of particulate contaminants, including dioxin, lead, PCB*s, and asbestos fibers, and to all types of surfaces. Dusting/vacuuming/wiping is the state-of-the-art method for removing dioxin-contaminated dust from the interior of homes and buildings.

(6) Flaming refers to the application of controlled high temperature flames to contaminated noncombustible surfaces, providing complete and rapid destruction of all residues contacted. The flaming process has been used by the Army to destroy explosive and low-level radioactive contaminants on building surfaces. Its applicability to other contaminants is not well known. This surface decontamination technique is applicable to painted and unpainted concrete, cement, brick, and metals. Subsurface decontamination of building materials may be possible, but extensive damage to the material would probably result. This technique can involve high fuel costs.

(7) Fluorocarbon extraction of contaminants from building materials involves the pressure-spraying of a fluorocarbon solvent onto the contaminated surface followed by collection and purification of the solvent. RadKleen is an example of a commercial process that uses Freon 113 (1,1,2-trichloro-1,2,2-trifluoroethane or $C_2Cl_3F_3$) as the solvent. The RadKleen process is currently used for cleaning radioactive material from various surfaces. It has been applied to chemical agents on small objects, and thus field capability has been demonstrated. Studies have been conducted for agent-contaminated clothing materials, such as polyester-cotton, Nomex, butyl rubber gloves, and charcoal-impregnated cloth. Although this method has not been demonstrated for removing contaminants from building surfaces, it looks very promising.

(8) Gritblasting is a removal technique in which abrasive materials (such as sand, alumina, steel pellets, or glass beads) are used for uniform removal of contaminated surfaces from a structure. Gritblasting has been used since 1870 to remove surface layers from metallic and ceramic objects and is currently used extensively. For example, sandblasting is commonly used to clean the surfaces of old brick and stone buildings. Gritblasting is applicable to all surface contaminants except some highly sensitive explosives such as lead azide and lead styphnate. This method is applicable to all surface materials except glass, transite, and Plexiglas.

(9) Hydroblasting/waterwashing refers to the use of a high-pressure (3500 to 350,000 kPa) water jet to remove contaminated debris from surfaces. The debris and water are then collected and thermally, physically, or chemically decontaminated. Hydroblasting has been used to remove explosives from projectiles, to decontaminate military vehicles, and to decontaminate nuclear facilities. Hydroblasting also has been employed commercially to clean bridges, buildings, heavy machinery, highways, ships, metal coatings, railroad cars, heat exchanger tubes, reactors, piping, etc. Off-the-shelf equipment is available from many manufacturers and distributors.

(10) Microbial degradation is a developing process whereby contaminants are biologically decomposed by microbes capable of utilizing the contaminant as a nutrient source. Conceptually, microbes are applied to the contaminated area in an aqueous medium and allowed to digest the contaminant over time; the microbes are then destroyed chemically or thermally and washed away. Microbial degradation as a building decontamination technique has not been demonstrated.

(11) Painting/coating/stripping includes the removal of old layers of paint containing high levels of toxic metals such as lead, the use of fixative/stabilizer paint coatings, and the use of adhesive-backed strippable coatings.

(a) In the first technique, paint containing lead in excess of 0.06 percent is removed from building surfaces by commercially available paint removers and/or physical means (scraping, scrubbing, waterwashing). Resurfacing or further decontamination efforts may be necessary.

(b) The second technique involves the use of various agents as coatings on contaminated surfaces to fix or stabilize the contaminant in place, thereby decreasing or eliminating exposure hazards. Potentially useful stabilizing agents include molten and solid waxes, carbo-waxes (polyoxyethylene glycol), saligenin ("2-dihydroxytoluene), organic dyes, epoxy paint films, and polyester resins. The stabilized contaminants can be left in place or removed later by a secondary treatment. In some cases, the stabilizer/fixative coating is applied in situ to desensitize a contaminant such as an explosive residue and prevent its reaction or ignition during some other phase of the decontamination process.

(c) In the third technique, the contaminated surface is coated with a polymeric mixture. As the coating polymerizes, the contaminant becomes entrained in the lattice of or attached to the polymer molecules. As the

polymer layer is stripped or peeled off, the residue is removed with it. It may be possible, in some cases, to add chemicals to the mixture to inactivate the contaminants.

(12) Sealing is the application of a material such as paint that penetrates a porous surface and immobilizes contaminants in place. One example is K-20, a newly developed commercial product. The effectiveness of this product is not fully known. Although it acts more as a barrier than a detoxifier, K-20 may facilitate chemical degradation as well as physical separation of some contaminants.

(13) Photochemical degradation refers to the process of applying intense ultraviolet light to a contaminated surface for some period of time. Photodegradation of the contaminant follows. In recent years, attention has been focused on this method because of its usefulness in degrading chlorinated dioxins (TCDD in particular). Three conditions have been found to be essential for the process to proceed: the ability of the compound to absorb light energy, the availability of light at appropriate wavelengths and intensity, and the presence of a hydrogen donor.

(14) Scarification is a method that can be used to remove up to an inch of surface material from contaminated concrete or similar materials. The scarifier tool consists of pneumatically operated piston heads that strike the surface, causing concrete to chip off. This technique has been used in the decommissioning of nuclear facilities and in the cleanup of military arsenals.

(15) Solvent washing refers to the application of an organic solvent (e.g., acetone) to the surface of a building to solubilize contaminants. This technique has not yet achieved widespread use in building decontamination although it is beginning to be used in the decommissioning of nuclear facilities. The method needs further development in application, recovery, collection, and efficiency. The hot solvent soaking process has been shown to be effective in decontamination of PCB-contaminated transformers.

(16) Steam cleaning physically extracts contaminants from building walls and floors and from equipment. The steam is applied through hand-held wands or automated systems, and the condensate is collected in a sump or containment area for treatment. This method is currently used by explosives handling and manufacturing facilities. It has also been used to remove dioxin-contaminated soil from vehicles and drilling equipment.

b. Decontamination of Solid Materials and Buildings.

(1) Demolition of a building, structure, or piece of equipment includes complete burndown, controlled blasting, wrecking with balls or backhoe-mounted rams, rock splitting, sawing, drilling, and crushing. Many of these techniques have been employed for nuclear facility decontamination and for the cleanup of military arsenals.

(2) Dismantling refers to the physical removal of selected structures (such as contaminated pipes, tanks, and other process equipment) from buildings or other areas. It can be the sole decontamination activity (e.g.,

removal of contaminated structures from an otherwise clean building), or it can be used in the initial stage of a more complex building decontamination effort (e.g., removal of structures prior to flaming, hydroblasting, or other cleanup techniques).

(3) Asbestos abatement consists of four techniques: removal, encapsulation, enclosure, and special operations (e.g., maintenance and monitoring). In removal operations, all friable asbestos-containing building materials are completely removed to eliminate the release of asbestos fibers into the air. The other techniques leave the asbestos fibers in place but limit potential exposure levels through various treatment, maintenance, and inspection procedures.

(4) Encapsulation/enclosure physically separates contaminants or contaminated structures from building occupants and the ambient environment by means of a barrier. An encapsulating or enclosing physical barrier may take different forms; among them are plaster epoxy and concrete casts and walls. Acting as an impenetrable shield, a barrier keeps contaminants inside and away from clean areas, thereby alleviating the hazard. As a result, contamination of part of a structure will not result in the contamination of adjacent areas. Encapsulation has been used on damaged asbestos insulation, leaky PCB-contaminated electrical transformers, and open maintenance pits and sumps contaminated by heavy metals.

(5) Vapor-phase solvent extraction is a method in which an organic solvent with a relatively low boiling point (such as methyl chloride or acetone) is heated to vaporization and allowed to circulate in a contaminated piece of equipment or an enclosed area. The vapors permeate the contaminated materials, where they condense, solubilize contaminants, and diffuse outward. The contaminant-laden liquid solvent is collected in a sump and treated to allow recycling of the solvent. This method has not yet been applied to building decontamination, although it is believed to have good potential.

c. Data Requirements. Figure 3-14 summarizes the strategy for dealing with building decontamination, including guidance and information for selecting the least costly method that is technologically feasible and that will effectively reduce contamination to predetermined levels.

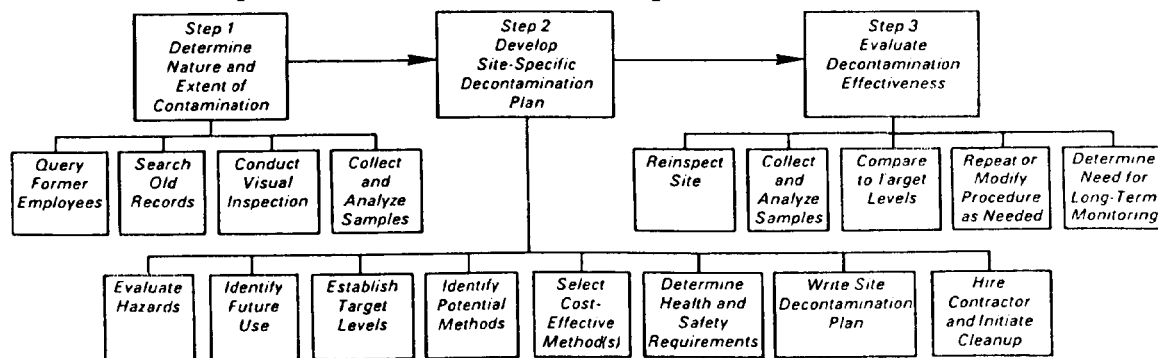

Figure 3-14. Flow Diagram for Developing a Structural Decontamination Strategy

(1) Sampling methods for determining the type and degree of contamination existing on building/structure/equipment surfaces, both before and after cleanup efforts, are poorly developed, documented, and verified. Similarly, subsurface sampling techniques (such as corings) or determining the depth of contamination in porous substances (such as concrete or wood floors) have not been adequately developed and documented. Although "wipe tests" are often referred to in site records, the actual methodology used is rarely described in enough detail to allow simulation or reproduction by others, and the technique itself is known to be inadequate for quantitatively transferring contaminants from surfaces to wipes or swabs.

(2) The applicability and effectiveness of decontamination techniques for treating various contaminant/structural material combinations encountered at Superfund sites have not been fully explored. For example, the degree to which steam cleaning removes dioxin-contaminated soil particles from drilling augers has not been established, even though this method is routinely used to clean equipment at dioxin-contaminated sites.

(3) The individual methods described above should be used as a general guide in evaluating the potential of each technique on a site-specific basis for efficiency, wastes generated, equipment and support facilities needed, time and safety requirements, structural effects, and costs. Also, each method or combination of methods should be pretested in the laboratory or at the site before full-scale implementation to determine the effectiveness of the strategy.

(4) A formal, systematic approach for determining acceptable levels of contaminants remaining in and on building and equipment surfaces does not currently exist. As a result, guidance on how clean is clean and the establishment of target levels must continue to be addressed case by case.

d. Design Criteria. There are no established design criteria for decontamination of structures. Specification of appropriate cleanup strategies depends highly on the professional judgment of the designer.

3-11. Decontamination of Miscellaneous Media. Sanitary sewers located downgradient from uncontrolled hazardous waste disposal sites may become contaminated by infiltration of leachate or polluted ground water through cracks, ruptures, or poorly sealed pipe joints. Typically the vitrified clay pipes (VCP) commonly used for gravity sewers are susceptible to cracking from root intrusion or settling. The interior cleaning of contaminated pipes will facilitate the location of cracks and joint failures which ultimately must be sealed to prevent further infiltration of contaminated soil and water. Available sewer-cleaning techniques include mechanical scouring, hydraulic scouring and flushing, bucket dredging, suction cleaning with pumps or vacuums, chemical absorption, or a combination of these methods. Manholes, flushing inlets, and unplugged residential service connections provide access points to sewers.

a. Mechanical Scouring. This is an effective method to remove pipeline obstacles such as roots, stones, greases, sludges, and corrosion modules.

Solidified masses of toxic chemical precipitates can also be removed by mechanical scouring. Mechanical scouring techniques include the use of power rodding machines ("snakes"), which pull or push scrapers, augers, or brushes through the sewer line. "Pigs" are bullet-shaped plastic balls lined with scouring strips that are hydraulically propelled at high velocity through water mains to scrape the interior pipe surface.

b. Hydraulic Scouring. Contaminated sewer lines can be cleaned by running high-pressure fire hoses through manholes into the sewer and flushing out sections. Hydraulic scouring is often used after mechanical scouring devices have cleared the line of solid debris or loosened contaminated sediments and sludges coating the interior surface of the pipe. When using hydraulic scouring techniques large volumes of contaminated water may be produced.

c. Bucket Dredging and Suction Cleaning. A bucket machine can be used to remove grit or contaminated soil from a sewer line. Power winches are set up over adjacent manholes with cable connections to both ends of the collection bucket. The bucket is then pulled through the sewer line until loaded with debris. The same technique can also be used to pull "sewer balls" or "porcupine scrapers" through obstructed sewer lines. Suction devices such as pumps or vacuum trucks may be used to clean sewer lines of toxic liquids and debris.

Section II. Contaminated Ground-Water Plume Management

3-12. Ground-Water Pumping Systems. Two common ground-water pumping systems use either wellpoints or extraction/injection wells.

3-13. Wellpoint Systems. Wellpoint systems are generally used to control ground-water levels or flow patterns at construction sites. They are inexpensive to install and use techniques and equipment that are readily available. Major disadvantages are the requirement for maintenance and the energy used for pumping.

a. Applications.

(1) Wellpoint systems may be used to lower the water table or to dewater a selected area. They consist of a series of wellpoints with one or more pumping systems and can serve a variety of purposes. The withdrawn water can be discharged with or without further treatment.

(2) These systems are generally used at sites with relatively shallow water tables and fairly permeable soils. In general, if the water table is near the surface and is to be lowered to a depth of 6.1 m (20 feet) or less, wellpoints and suction pumps can be employed. If deeper drawdown is needed, a well system using jet or submersible pumps or eductor wellpoints must be employed.

b. Design and Construction Considerations. The lowering of the water table by using a wellpoint dewatering system is presented in Figure 3-15. The system consists of a group of closely spaced wells, usually connected by a header pipe and pumped by suction centrifugal pumps, submersible pumps, or jet ejector pumps, depending on the depth of pumping and the volume to be dewatered.

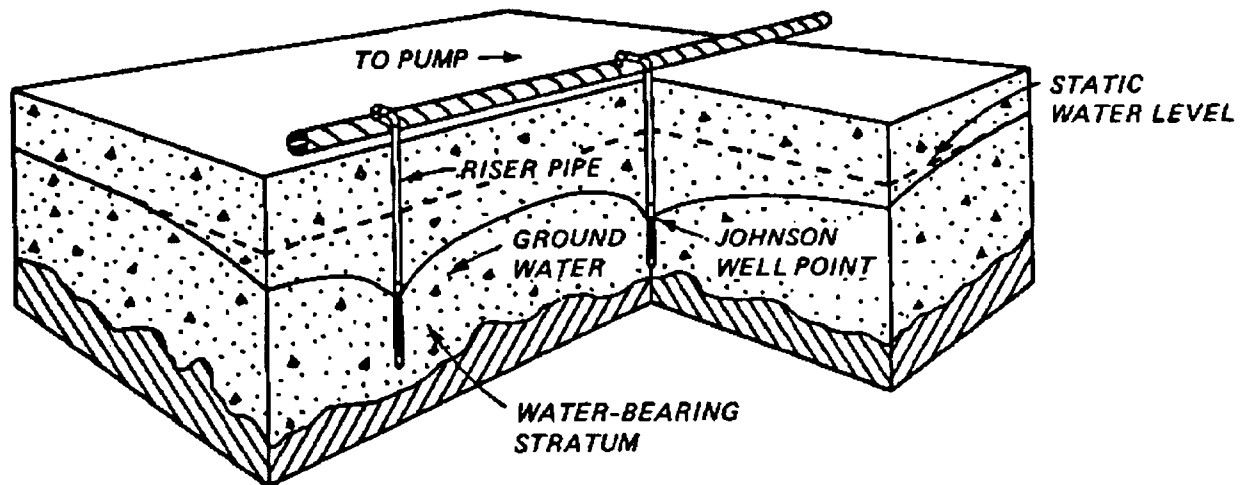

Figure 3-15. Schematic of a Wellpoint Dewatering System

(1) Hydraulic gradient. The hydraulic gradient increases as the flow converges toward a well. As a result, the lowered water surface develops a continually steeper slope toward the well. The form of this surface resembles a cone-shaped depression. The distance from the center of the well to the limit of this cone of depression is called the radius of influence. The hydraulic conductivity (K) is measured using the Darcy, defined as the permeability that will lead to a specific discharge of 1 cm/s for a fluid with a viscosity of 1 cp. It is approximately equal to 10^{-8} cm/s. The value of K depends upon the size and arrangement of the particles in an unconsolidated formation and the size and characteristics of the surfaces of crevices fractures, or solution openings in a consolidated formation. Figure 3-16 shows typical hydraulic conductivity for various soil and rock types. Darcy's law remains valid only under conditions of laminar flow, involving fluids with a density not significantly higher than pure water.

(2) Transmissivity and storage coefficients. Two other factors, the transmissivity (T) and storage (S) coefficients, also affect the rate of flow. The coefficient of transmissivity indicates how much water will move through a formation and is equivalent to the permeability times the saturation thickness of the aquifer. The coefficient of storage indicates how much water can be removed by pumping and draining and is defined as the volume of water released from or taken into storage per unit area of aquifer per unit change in hydraulic head normal to the surface.

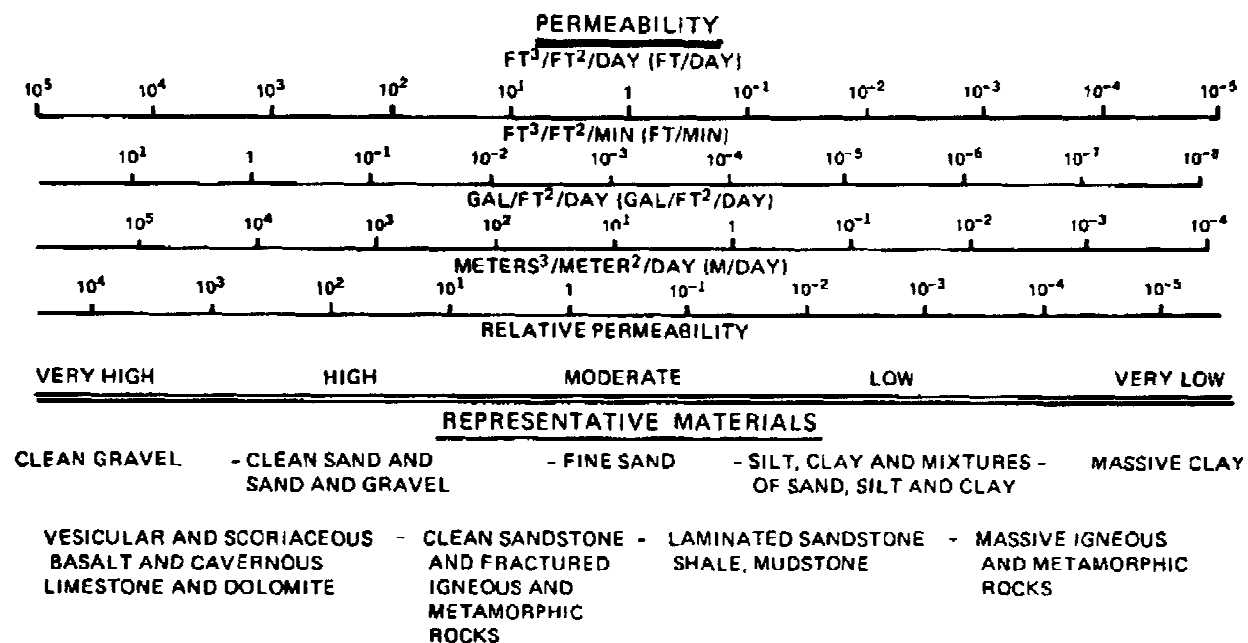

Figure 3-16. Hydraulic Conductivities of Soil and Rock

(3) Cone of depression. Lowering the ground-water level over the complete site involves creating a composite cone of depression by pumping from the wellpoint system. The individual cones of depression must be close together so that they overlap and thus pull the water table down several feet at intermediate points between pairs of wells.

(4) Stagnation points. Stagnation points occur when areas in the wellpoint field lie outside the area of influence of any of the wells. Design of the well-array should strive to reduce or eliminate stagnation points. Their presence leaves zones of high contaminant concentration and greatly lengthens the time necessary to clean the aquifer. The inclusion of injection wells can aid in the elimination of stagnation points.

(5) Drawdown. Once the aquifer properties of transmissivity and storativity have been determined, it is possible to predict the drawdown in hydraulic head in a confined aquifer at a distance (r) from the well and at a time (t) for a given pumping rate (Q). Thus, by determining the drawdown at various radii from the well, one can determine the radius of influence for a given pumping rate. For a given aquifer, the cone of depression initially increases in depth and extent with increasing pumping time until eventually it levels off. Drawdown at any point at a given time is directly proportional to the pumping rate and inversely proportional to aquifer transmissivity and storativity.

(6) Design considerations. Designs of wellpoint dewatering systems can vary considerably, depending on the depth to which dewatering is required, the transmissivity and storativity of the aquifer, the size of the site, and the depth of the waterbearing formation.

(7) Spacing. Wellpoint spacing is based on the radius of influence of each well and the composite radii of influence needed to lower the water table. Once storage and transmissivity coefficients have been determined, the drawdown and area of influence may be calculated. In practice, spacing for a few wellpoints would be determined and then field tested; any necessary adjustments would then be made to account for the fact that wells do not always meet the idealized conditions assumed in equations to estimate drawdown.

(8) Time to clean up. The time to clean up an aquifer is difficult to predict as it depends upon a wide variety of factors:

Contaminant type	Water solubility, volatility, mobility, polarity, absorption characteristics
Site soil type	Permeability, storage capacity, clay type and content, grain size, presence of clay lenses and impermeable barriers
Aquifer characteristics	Rate of flow, depth and thickness, recharge rate, perched water tables, contaminate concentrations

Pumping may be necessary for extended periods of time. Typically the concentration of contaminants in the extracted ground water falls asymptotically toward zero so that the demand on treatment equipment lessens over time. A good design will take into account this effect by incorporating unit operations that can be removed or reworked to be effective on the lower and lower contaminant concentrations. This is especially important to bioremediation systems where contaminant concentrations may soon fall to levels which will not sustain microbe populations. Further, "When is an aquifer clean?" is a difficult question.

(9) Ground-water treatment and disposal. The treatment of the contaminated ground water is a major consideration. Extracted ground water must be treated before discharge or reinjection. Treatment systems have been designed with stripping (air or steam) units for volatiles (perhaps with carbon absorption or incineration units for the stripped air stream), carbon absorption units, ion-exchange units, and/or bioreactors. These can be arranged singly or in series. Treated effluent may be discharged to the local publicly owned treatment works (POTW)(which may remove the need for pretreatment), injection wells incorporated into ground-water cleanup design, and seepage basins or trenches. Disposal of large volumes of extracted ground water over long time periods can be a major consideration and expense.

c. Installation.

(1) Wellpoints are made to be driven in place, to be jetted down, or to be installed in open holes. The most common practice is to jet the wellpoints down to the desired depth, to flush out the fines, leaving the coarser fraction of material to collect in the bottom of the hole, and then to drive the point into the coarser materials.

(2) A method used in some unstable material consists of jetting down or otherwise sinking temporary casing into which the wellpoint and riser pipe are installed. As the casing is pulled, gravel may be placed around the wellpoint.

d. Special Cases.

(1) In special cases, design modifications will be required or at least various methods should be compared for cost-effectiveness. Fine silts and other slowly permeable materials cannot be readily drained by wellpoint systems alone. However, soils can be partially drained and stabilized by vacuum wells or wellpoint systems that create negative pore pressure or tension in the soil. The wellpoints should be gravel packed from the bottom of the hole to within a few feet from the surface of the poorly permeable material. The remainder of the hole should be sealed with bentonite or other impermeable materials. If a vacuum is maintained in the well screen or pack, flow toward the wellpoints is increased. Such a system usually requires closely spaced wellpoints, and pumping capacity is reduced. Vacuum booster pumps may be required on the headers or individual wells for effective operation.

(2) Vertical sand drains may be used in conjunction with wellpoints to facilitate drainage in stratified soils. The drains, usually 406 to 508 mm (16 to 20 inches) in diameter, are installed on 1.8 to 3 m (6- to 10-foot) centers through the impermeable layers that need to be dewatered and are extended to underlying permeable layers where wellpoints are placed.

(3) Two or more wellpoint systems may be required when two or more strata of water-bearing sand are separated by impermeable barriers. The depth for dewatering will be different for each system, and consequently pipe lengths and diameters and pumping requirements will be determined independently.

(4) Potential enhancements of ground-water cleanup may involve the use of in-situ bioremediation. Introduction of nutrients and/or oxygen (or hydrogen peroxide) into the injection wells may greatly increase the rate of in-situ contaminant breakdown and thus enhance cleanup. Steam or hot water injection may help to dissolve or mobilize slightly soluble or adsorbed contaminants and increase their rate of removal.

e. Advantages and Disadvantages. Advantages and disadvantages of wellpoint pumping to adjust the water table are as follows:

<u>Advantages</u>	<u>Disadvantages</u>
High design flexibility	May not adequately drain fine silty soils, and flexibility is reduced in this medium
Good onsite flexibility since the system can be easily dismantled	
Construction costs may be lower than for construction of artificial ground-water barriers	Higher operation and maintenance costs than for artificial ground-water barriers
Good reliability when properly monitored	System failures could result in contaminated drinking water

3-14. Extraction/Injection Well Systems. Extraction/injection control systems have been used at waste sites to alter natural ground-water gradients to prevent pollutants from leaving a site or to divert ground water that might enter a site. Where hazardous wastes are involved, pumped systems may be used in conjunction with ground-water barriers. Pumped systems that result in mixing contaminated and uncontaminated ground waters can create large volumes of contaminated ground water to be treated. In most cases contaminated ground water at waste sites is contained by installing extraction wells to extract ground water from under the site, collecting contaminants leaking from the waste and creating a local gradient toward the site. Water withdrawn from under the site may have to be treated before discharge or reinjection. Two applications of extraction/injection systems to contain a plume are the use of a series of extraction and injection wells that will allow water within the plume to be pumped, treated, and pumped back into the aquifer and pumping and treatment of the plume followed by recharge using seepage basins.

a. Applications.

(1) Hydraulic barriers. Plume containment with the use of extraction/injection wells is an effective means of preventing the eventual contamination of drinking water wells or the pollution of streams or confined aquifers that are hydraulically connected to the contaminated ground water (Figure 3-17). The technique may be particularly useful for surface impoundments. One design would use extraction/injection wells separated by physical barriers (slurry wall or sheet pilings). The extraction wells are placed upgradient from the barrier; the extracted ground water is treated and reinjected on the downgradient side of the barrier. This design can keep contaminated ground water from leaving the site.

(2) Plume and floating product recovery. Extraction wells are used to directly recover separate liquid phases such as petroleum products which are floating at the water table. Well screens are placed such that the product can be collected and separated from any contamination ground water at the land surface in standard oil-separation units. Separated ground water usually must be treated to remove any soluble organics, carbon absorption, or biotreatment being used. Soluble materials dissolved in the ground water can also be

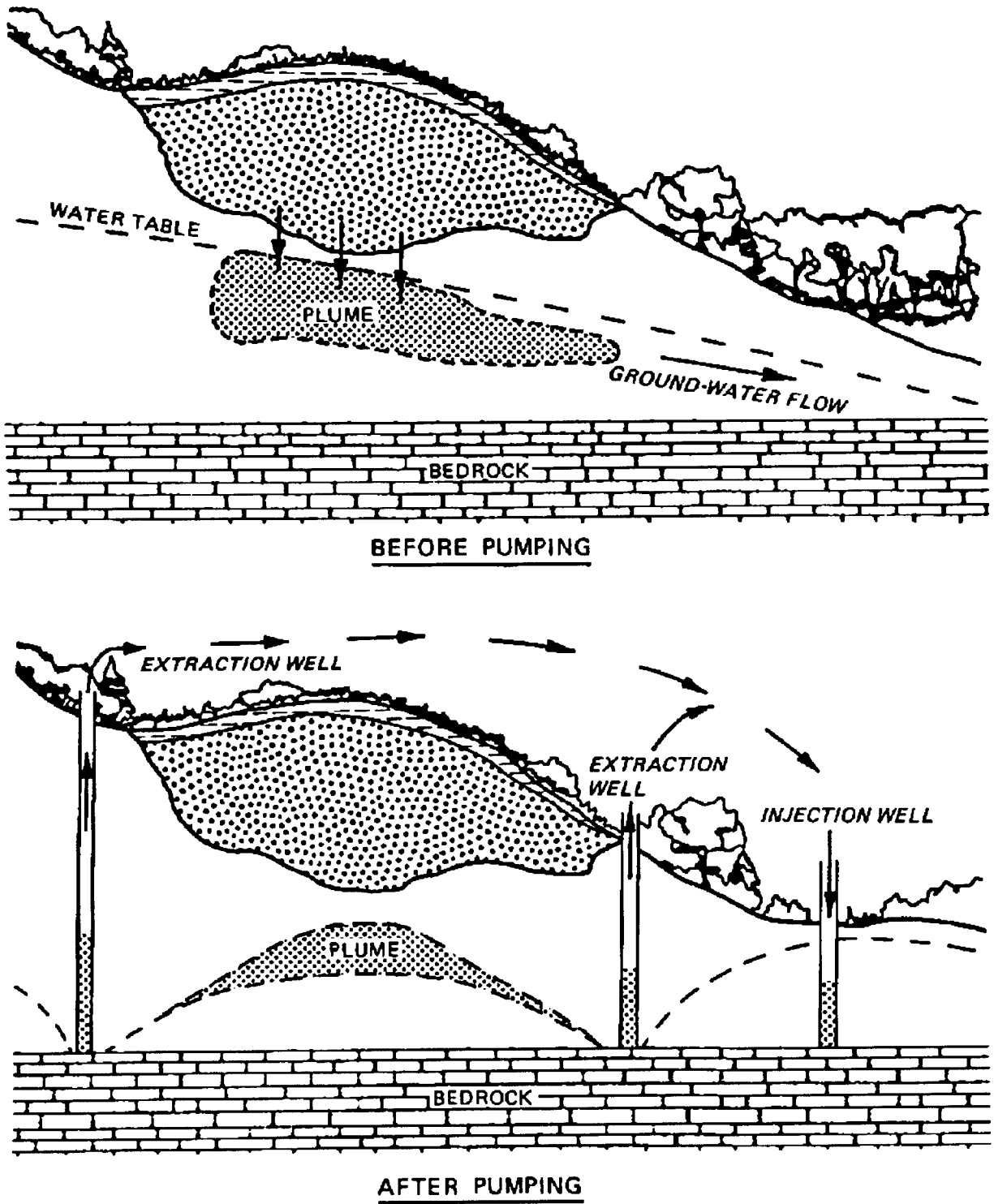

Figure 3-17. Use of Extraction/Injection Wells for Plume Containment
(Source: EPA 1982)

separated and recovered using extraction wells followed by carbon absorption or reverse osmosis, or they can be destroyed using biotreatment. Judicious placement of injection wells can increase the rate of cleansing of the aquifer.

b. Design and Construction Considerations.

(1) Definition of the plume area, depth, and flow rate and direction must be determined before any further design considerations can be addressed. Pump tests should include determination of transmissivity and storage coefficients, and radii of influence of test wells. The presence of perched water tables or other anomalies must also be assessed.

(2) The basis of plume management by pumping depends upon incorporating the plume within the radius of influence of an extraction well. Such a system requires careful monitoring to determine the extent of the plume and any changes that may occur in the plume as pumping continues.

(3) The effect of the injection wells on the drawdown and radius of influence of the extraction wells is illustrated Figure 3-18. As the cone of depression expands and eventually encounters the cone of impression from the recharge well, both the rate of expansion of the cone and the rate of drawdown are slowed. With continued pumping, the cone of depression expands more slowly until the rate of recharge equals the rate of extraction and the drawdown stabilizes. Thus, the effect of the injection well is to narrow the radius of influence and to decrease the drawdown with increasing distance from the well.

(4) By combining extraction and injection wells in the design, the rate of cleanup of the aquifer and the amount of groundwater contaminated may be decreased. The cone of impression (Figure 3-18) of the injection well will serve to isolate the extraction wells from the surrounding ground water and increase the rate of flow (head gradient) toward the extraction well.

(5) The simplest extraction/injection well systems are designed so that the radii of influence do not overlap. Another important reason for placing the wells distant enough so that their radii of influence do not overlap is that any changes that must be made in pumping as a result of changes in the plume due to age of the landfill, quantity of precipitation, and physical changes in the size of the landfill, due to compaction or excavation, would be complicated by the effect of the overlap of the areas of influence.

(6) In some instances site limitations may require that the extraction and injection wells be placed so close together that the radii of influence overlap. Overlapping injection/extraction well zones of influence may be used to increase the rate of flow of ground water through the contaminated site in order to increase the rate of flushing of the contaminants.

(7) An example of an effective system for plume containment is currently operating at the Rocky Mountain Arsenal. Ground water is extracted, treated, and recharged through injection wells to the downgradient side of an impermeable barrier (slurry wall). The completed system will handle a flow of

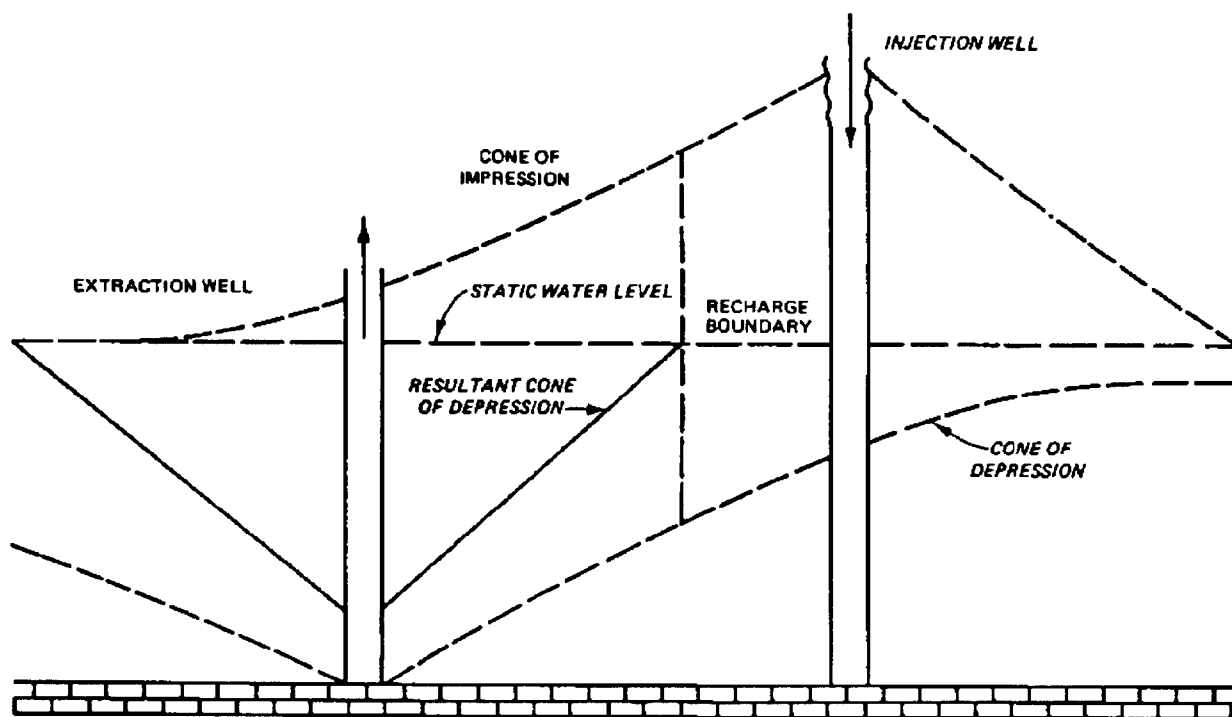

Figure 3-18. Effect of an Injection Well on the Cone of Depression

28 l/s (443 gpm) and extend for 1585 m (5,200 feet). The system will consist of about 33 extraction wells, most of which are 203 mm (8 inches) in diameter, and approximately 40 injection wells with a diameter of 406 to 508 mm (16 to 18 inches). The extraction and injection systems are separated by an impermeable barrier to prevent mixing of contaminated and uncontaminated water.

c. Ground-water Pumping with Recharge through Seepage Basins.

(1) As a less costly alternative to recharging water through injection wells, seepage basins or recharge basins can be used. Since seepage basins require a high degree of maintenance to ensure that porosity is not reduced, they would not be practical where several basins are required for recharge of large volumes of water or where adequate maintenance staff is not available.

(2) As is the case for extraction/injection well systems, the effects of recharge on the cone of depression must be accounted for in designing a system that will contain the plume. Ideally, the recharge basins should be located outside the area of influence of the extraction wells.

(3) The dimensions of a recharge basin vary considerably. The basin should be designed to include an emergency overflow and a sediment trap for run-off from rainwater. The side walls of the basin should be pervious since considerable recharge can occur through the walls.

d. Advantages and Disadvantages. The advantages and disadvantages of the extraction/injection systems used for plume containment are as follows:

<u>Advantages</u>	<u>Disadvantages</u>
System may be less costly than construction of an impermeable barrier	Plume volume and characteristics will vary with time, climatic conditions, and changes in the site resulting in costly and frequent monitoring
High degree of design flexibility	
Moderate to high operational flexibility, which will allow the system to meet increased or decreased pumping demands as site conditions change	System failures could lead to contamination of drinking water O&M costs are higher than for artificial barrier

3-15. Subsurface Barriers. The most common subsurface barriers are slurry-trench cutoff walls, grout curtains, sheet pile cutoff walls, membranes and synthetic sheet curtains, and combination barrier pumping systems.

3-16. Slurry-trench Cutoff Walls. Slurry trenching is a method of constructing a passive subsurface barrier or slurry wall to impede or redirect the flow of ground water. This practice covers a range of construction techniques from the simple to the quite complex, and though it is becoming more common, is still performed by only a few specialty contractors. In recent years the success and economy of slurry trench cutoffs has largely brought about the replacement of other methods such as grout curtain and sheet piling cutoffs.

a. Description.

(1) Slurry walls are fixed underground barriers formed by pumping slurry into a trench as excavation proceeds. The slurry is usually a soil or cement, bentonite, and water mixture pumped into the trench to maintain a slurry-full trench condition. The cement-bentonite slurry is allowed to set. The soil-bentonite trench filling is produced by backfilling the trench with a suitably engineered backfill which often includes local or excavated site soil.

(2) The slurry used in the soil-bentonite is essentially a 4 to 7 percent by weight suspension of bentonite in water. Bentonite is a clay of the montmorillonite group of 2:1 expanding lattice clays. Excavated materials that are removed from the slurry-filled trench are placed at the trench sides and excess slurry drains back into the trench. Selected backfill material is dumped into the trench and sinks through the bentonite forcing some slurry out of the trench. Excess slurry is pumped to a holding area where the slurry can be "desanded" if necessary and adjusted to the specified density for reintroduction into the trench. No compaction of a finished slurry trench is required.

3) For proper displacement of slurry by the backfill material, the unit weight of backfill material should be 240.3 kg/m^3 (15 lb/ft^3) greater than that of the slurry (soil-bentonite). Typical soil-bentonite unit weights are 1442 kg/m^3 to 1682 kg/m^3 (90 to 105 lb/ft^3) and for cement-bentonite slurry 1922 kg/m^3 (120 lb/ft^3). Density requirements for a cement-bentonite slurry are less important because it is not backfill displaced; however, a 90-day minimum set time is important.

b. Applications.

(1) Slurry walls were first used to effect ground-water cutoff in conjunction with large dam projects. In recent years, they have found use as both ground-water and leachate barriers around hazardous waste disposal sites. Placement of the wall depends on the direction and gradient of ground-water flow as well as location of the wastes. When placed on the upgradient side of the waste site, a slurry wall will force the ground water to flow around the wastes. In some instances, it may be unnecessary to sink the wall down to an impervious stratum. A wall sunk far enough into the water table upgradient from the wastes can reduce the head of the ground-water flow, causing it to flow at greater depth beneath the wastes.

(2) Most commonly, the trench is excavated down to, and often into, an impervious layer in order to retard and minimize a ground-water flow. This may not be the case when only a lowering of the water table is required. The width of the trench is typically from 0.61 to 1.5 m (2 to 5 feet) and can be up to 24.4 m or 30.5 m (80 or 100 feet) deep. Typically, a backhoe, clamshell, or dragline is used for excavation.

(3) Grades of 10 percent and higher provide problems for slurry-trench construction.

(4) Ground-water chemistry can severely affect the behavior at the bentonite slurry. Adverse reactions such as thickening or flocculation may result if grout and ground water are not compatible. Compatibility tests have been conducted to determine the ability of bentonite slurry walls to withstand the effects of certain pollutants, and the results are encouraging. Of the chemicals tested, only alcohols were found to completely destroy the slurry wall. To determine the probable effectiveness of a slurry wall for a particular site, however, compatibility tests should be conducted using the actual leachate from the site.

(5) In certain settings, a slurry wall can be installed to completely surround the site. In some cases, the ground water inside the slurry wall is extracted and treated, and in some cases replaced with the treated ground water.

(6) Where slurry cutoffs are used in conjunction with a cap, the wall-cap tie-in should facilitate construction and be of adequate thickness to prevent separation as a result of long-term settlement of the wall. Tie-in with an impervious layer beneath the wall is also important if ground-water cutoff is the objective.

(7) A slurry trench cutoff wall was designed and constructed to contain migration of contaminated ground water from the Lipari Landfill in Pitman, New Jersey, in October 1983. The trench was approximately 883.4 m (2,900 feet) long and 15.2 m (50 feet) deep. The bottom of the trench was keyed into a Kirkwood clay layer. The design drawing illustrating the position of the trench is presented in Figure 3-19. Depending on the grade and the position of the trench in relation to the batch-mixing operation performed in a clean area onsite, between 22.9 and 45.7 m (75 and 150 feet) of slurry trench could be constructed each day. The entire trench was constructed in two months.

c. Design and Construction Considerations.

(1) Slurry trenching must be preceded by thorough hydrogeologic and geotechnical investigations. A good hydrogeologic study will tell the designers the depth, rate, and direction of ground-water flow, and the chemical characteristics of the water. A geotechnical investigation will provide information on soil characteristics such as permeability, amount of stratification, and depth to bedrock or an impervious layer. In addition, it will tell the nature and condition of the bedrock. When the slurry wall is intended to provide total water cutoff, rather than just to lower the water table, particular attention must be paid to the soil/rock interface.

(2) The type of equipment used to excavate a slurry trench depends primarily on the depth. Hydraulic backhoes can be used to excavate down to 16.8 m (55 feet). Beyond that depth, a clamshell shovel must be used. If it is necessary to install the slurry wall into hard bedrock, drilling or blasting may have to be used to excavate the rock. Special blasting techniques would be required to maintain the integrity of the bedrock.

(3) Backfilling of a trench is often accomplished with the equipment used to excavate the trench. A bulldozer can be used to mix the soil with the slurry alongside the trench as well as to backfill the upper portion of the trench. Care must be taken to ensure that no pockets of slurry are trapped during the backfilling, as these can greatly reduce the wall's effectiveness and permanence.

(4) For maximum permeability reduction, the soil/bentonite mixture used for backfilling should contain 20 to 25 percent fines (soil particles that will pass a 0.075 mm (200-mesh) sieve). To ensure long-term permeability reduction, as much as 40 to 45 percent fines may be required. In the event the onsite soils are too coarse, imported fines or additional bentonite must be added.

(5) The bentonite must be completely hydrated and well mixed with the soil or cement before being placed into the trench.

d. Advantages and Disadvantages. The process outlined above includes a number of variables that can affect the long-term effectiveness of a slurry wall. The extent to which these variables, such as ground water, soil, and rock characteristics, can influence the integrity of a wall can usually be determined by a variety of preconstruction tests. From the results of these

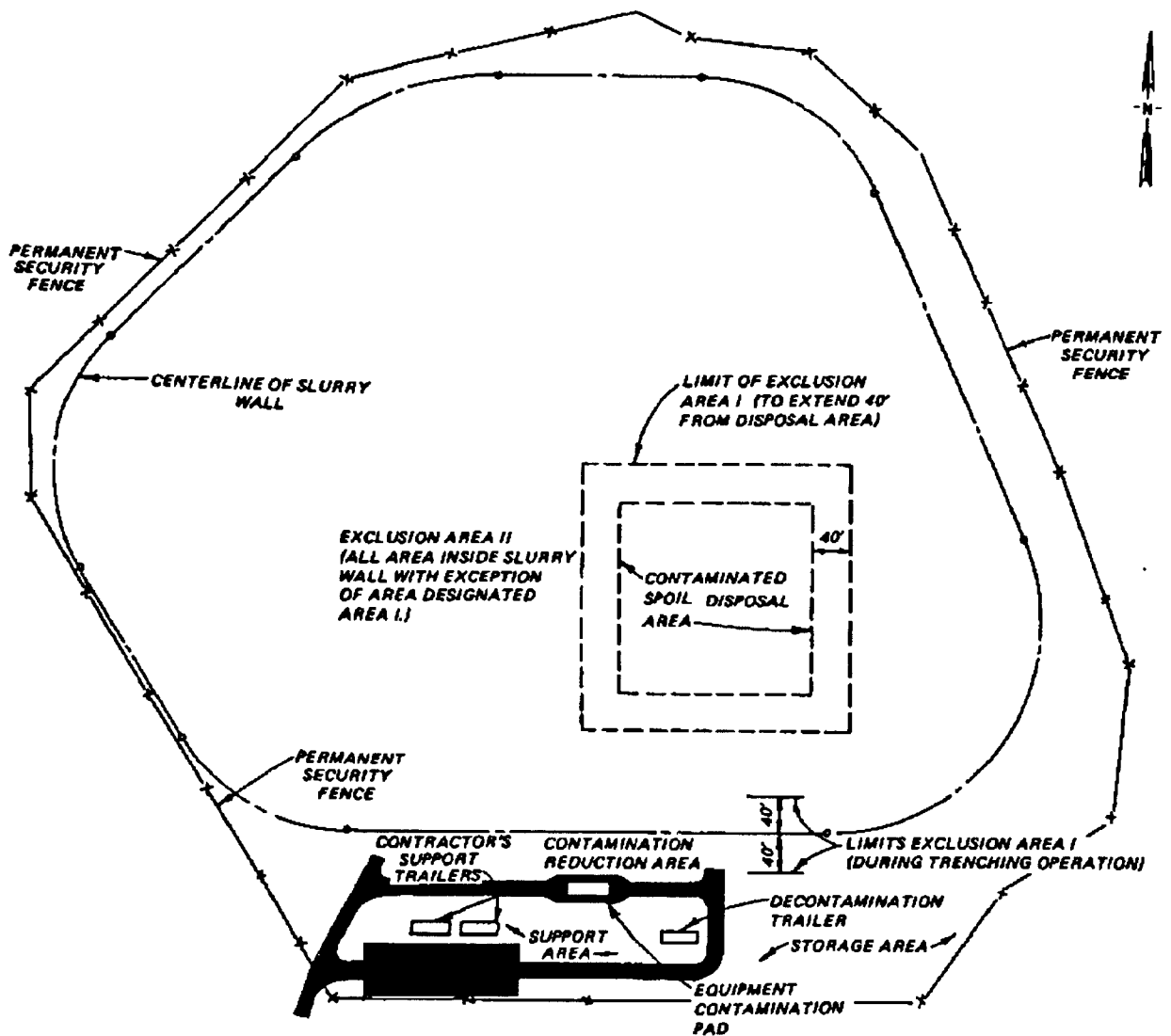

Figure 3-19. Design Drawing for Lipari Landfill Slurry-Trench Cutoff Wall

field and laboratory tests, more site deficiencies can be identified and corrected prior to construction. A properly designed and installed slurry wall can be expected to provide effective ground-water control for many decades with little or no maintenance. Advantages and disadvantages of slurry trenches are summarized below:

<u>Advantages</u>	<u>Disadvantages</u>
A long-term, economical method of ground-water control	Ground water or waste leachate may be incompatible with slurry material
No maintenance required over long term	Lack of near-surface impermeable layer, large boulders or underground caverns may make installation difficult or impractical
Materials inexpensive and available	
Technology well proven	Not practical with over 10 percent slope

3-17. Grout Curtains. Another method of ground-water control is the installation of a grout curtain. Grouting in general consists of the injection of one of a variety of special fluids or particulate grouts (Table 3-5) into the soil matrix under high pressure. The injection of the specific grout type is determined by conditions of soil permeability, soil grain size, chemistry of environment being grouted (soil and ground-water chemistry), and rate of ground-water flow. Grouting greatly reduces permeability and increases mechanical strength of the soil zone grouted. When carried out in the proper pattern and sequence, this process can result in a curtain or wall that can be an effective ground-water barrier. Because a grout curtain can be three times as costly as a slurry wall, it is rarely used when ground water has to be controlled in soil or loose overburden. The major use of curtain grouting is to seal voids in porous or fractured rock where other methods of ground-water control are impractical.

a. Description. The pressure injection of grout is as much an art as a science. The number of United States firms engaged in this practice is quite limited. The injection process itself involves drilling holes to the desired depth and injecting grout by the use of special equipment. In curtain grouting, a line of holes is drilled in single, double, or sometimes triple staggered rows (depending on site characteristics) and grouting is accomplished in descending stages with increasing pressure. The spacing of the injection holes is also site specific and is determined by the penetration radius of the grout out from the holes. Ideally, the grout injected in adjacent holes should touch (Figure 3-20) along the entire length of the hole. If this is done properly, a continuous, impervious barrier is formed (Figure 3-21).

b. Application.

(1) In general, grouts can be divided into two main categories- - suspension grouts and chemical grouts. Suspension grouts, as the name implies, contain finely divided particulate matter suspended in water. Chemical grouts, on the other hand, are true Newtonian fluids. Most of the grouting in the United States is done with suspension grouts, whereas about half of the grouting in Europe is done with chemicals. The principal grouts in use today are briefly described below.

Table 3-5. Significant Characteristics of Types of Grout

Type	Characteristic
Portland cement or particulate grouts	<p>Appropriate for higher permeability (larger grained) soils</p> <p>Least expensive of all grouts when used properly</p> <p>Most widely used in grouting across the United States (90 percent of all grouting)</p>
Chemical grouts	<p>Sodium silicate</p> <p>Most widely used chemical grout</p> <p>At concentrations of 10-70 percent gives viscosity of 1.5-50 cP</p> <p>Resistant to deterioration by freezing or thawing</p> <p>Can reduce permeabilities in sands from 10^{-2} to 10^{-8} cm/sec</p> <p>Can be used in soils with up to 20 percent silt and clay at relatively low injection rates</p> <p>Portland cement can be used to enhance water cutoff</p>
Acrylamide	<p>Should be used with caution because of toxicity</p> <p>First organic polymer grout developed</p> <p>May be used in combination with other grouts such as silicates, bitumens, clay, or cement</p> <p>Can be used in finer soils than most grouts because low viscosities are possible (1 cP)</p> <p>Excellent gel time control due to constant viscosity from time of catalysis to set/gel time</p> <p>Unconfined compressive strengths of 344-1378 KPa (50-200 psi) in stabilized soils</p> <p>Gels are permanent below the water table or in soils approaching 100 percent humidity</p> <p>Vulnerable to freeze-thaw and wet-dry cycles, particularly where dry periods predominate and will fail mechanically</p> <p>Due to ease of handling (low viscosity), enables more efficient installation and is often cost-competitive with other grouts</p>
Phenolic (Phenoplasts)	<p>Rarely used due to high cost</p> <p>Should be used with <u>caution</u> in areas exposed to drinking water supplies, because of toxicity</p> <p>Low viscosity</p> <p>Can shrink (with impaired integrity) if excess (chemically unbound) water remains after setting; unconfined compressive strength of 344-1378 KPa (50-200 psi) in stabilized soils</p>

(Continued)

Table 3-5. (Concluded)

Type	Characteristic
Urethane	Set through multistep polymerization Reaction sequence may be temporarily halted Additives can control gellation and foaming Range in viscosity from 20 to 200 cP Set time varies from minutes to hours Prepolymer is flammable
Urea-Formaldehyde	Rarely used due to high cost Will gel with an acid or neutral salt Gel time control is good Low viscosity Considered permanent (good stability) Solution toxic and corrosive Relatively inert and insoluble
Epoxy	In use since 1960 Useful in subaqueous applications Viscosity variable (molecular weight dependent) In general, set time difficult to regulate Good durability Resistant to acids, alkalis, and organic chemicals
Polyester	Useful only for specific applications Viscosity 250 to several thousand cP Set time hours to days Hydrolyzes in alkaline media Shrinks during curing Components are toxic and require special handling
Lignosulfonate	Rarely used due to high toxicity Lignin can cause skin problems and hexavalent chromium is highly toxic (both are contained in these materials) Cannot be used in conjunction with portland cement; pH*s conflict Ease of handling Loses integrity over time in moist soils Initial soil strengths of 344-1378 KPa (50-200 psi)

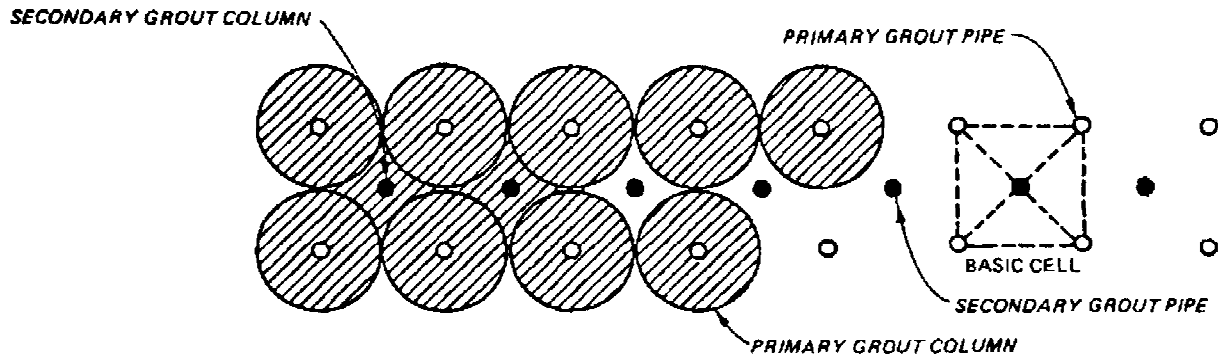

Figure 3-20. Grout Pipe Layout for Grout Curtain

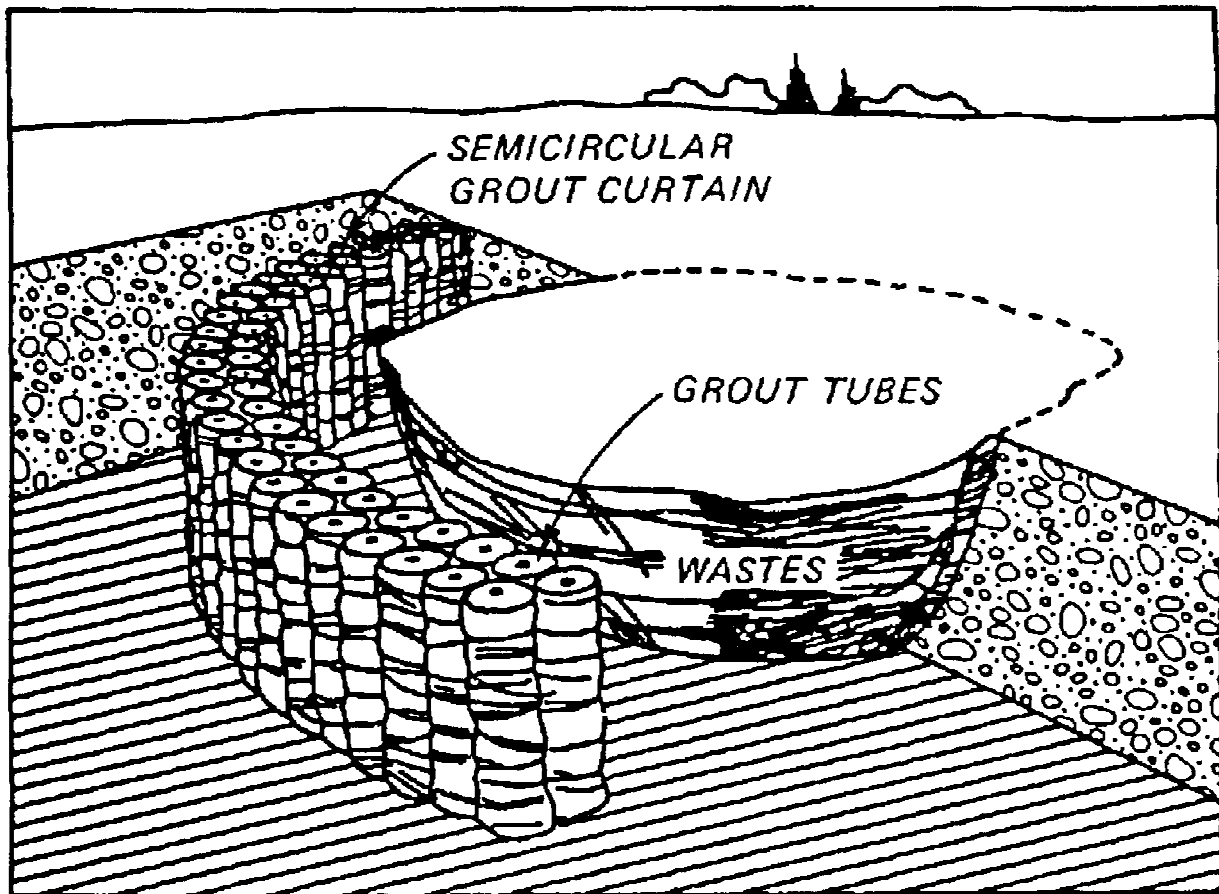

Figure 3-21. Semicircular Grout Curtain Around Waste Site

(2) Suspension grouts are for the most part either portland cement, bentonite, or a mixture of the two. Ultra-fine cement grouts are also available. Their primary use is in sealing voids in materials with rather high permeabilities, and they are often used as "pregrouts" with a second injection of a chemical grout used to seal the fine voids. If a suspension grout is injected into a medium that is too fine, filtration of the solids from the grout will occur, thus eliminating its effectiveness. Portland cement, when mixed with water, will set up into a crystal lattice in less than 2 hours. For grouting, a water-cement ratio of 0.6 or less is more effective. The smallest voids that can be effectively grouted are no smaller than three times the cement grain size. For this, it is clear that a more finely ground cement makes a more watertight grout. Portland cement is often used with a variety of additives that modify its behavior. Among these are clay, sand, fly ash, and chemical grouts.

(3) Of the clay minerals used for grouting, bentonite is by far the most common. Other locally available clays, especially those of marine or river origin, may be used but must be extensively tested and often chemically modified. Bentonite, however, because of its extremely small particle size (one micron or less), is the most injectable, and thus the best suited for grouting into materials with lower permeabilities. Medium- to fine-textured sands, with permeabilities of around 10^{-3} - 10^{-4} cm/sec, can be sealed with a bentonite grout. Dry bentonite is mixed with water onsite at a rate of 5 to 25 percent by dry weight. In these ratios, bentonite will absorb large amounts of water and, with time, form a gel. This gel, although it imparts little if any structural strength, is an extremely effective water barrier.

(4) Placement of a grout curtain downgradient from or beneath a hazardous waste site requires consideration of the compatibility of the grout to waste leachate or other extremes of ground-water chemistry. Little information is available concerning the resistance of grouts to chemical attack. Should a case arise where grout must contact leachate or ground water of extreme, field tests should be performed to verify grout resistance.

(5) Quality control is a difficult issue since even small voids or breaks can greatly lessen the effectiveness of a grout curtain. By definition, a grout curtain is not amenable to inspection.

c. Design and Construction Considerations.

(1) Pressure grouting is a high technology endeavor. As with slurry trenching, extensive geotechnical and hydrologic testing must precede the placement of a grout curtain. Boring, pumping, and laboratory tests will determine whether or not a site is groutable and will provide the necessary ground-water, rock, and soil information to allow for the choice of the best-suited grout or grouts. They will further provide the designer with the information needed to plan the pattern and procedure for injection.

(2) For all grouts the closer the viscosity is to that of water (1.0 cP), the greater the penetration power. Grouts with a viscosity less than 2 cP, such as many of the chemical grouts, can penetrate strata with permeabilities less than 10^{-5} cm/sec. Higher viscosity grouts, like

particulate and some chemical grouts with a viscosity greater than 10 cP, can only penetrate coarse strata having permeabilities greater than 10^{-2} cm/sec. For suspension particulate grouts, the particle size will also influence the ability to penetrate voids.

(3) Short-term deterioration of the grout can be caused by rapid chemical degradation or by an incorrect setting time. The effect on setting time can be caused by a miscalculation of the grout formulation, dilution of the grout by ground water, or changes caused by chemicals contained within the grouted strata.

(4) Once a grout has set in the voids in the ground, it must be able to resist hydrostatic forces in the pores that would tend to displace it. This ability will depend on the mechanical strength of the grout and can be estimated by the grout's shear strength. The shear strength of a grout will depend not only on its class, but also on its formulation. Thus, a class of grouts, such as silicates, can possess a wide range of mechanical strengths depending on the concentration and type of chemicals used in its formulation. The strength of the gel, then, can be adjusted, within limits, to the specific situation.

d. Advantages and Disadvantages.

(1) The advantage of grout curtain emplacement is the ability to inject grout through relatively small diameter drill holes at unlimited depths. The size of the pod or grouted column is a function of pore space volume and volume of grout injected. Grout can incorporate and/or penetrate porous materials in the vicinity of the injection well such as boulders or voids. Variable set times and low viscosities are also advantages.

(2) The major disadvantages of grouts are the limitations imposed by the permeability of the host material (soil or rock) and the uncertainty of complete cutoff. Specifically with particulate grouts only the most permeable units are groutable.

3-18. Sheet Pile Cutoff Walls. Sheet pile cutoff walls may be used to contain contaminated ground water, divert a contaminant plume to a treatment facility, and divert ground-water flow around a contaminated area. They constitute a permeable passive barrier composed of sheet piling permanently placed in the ground. Each section interlocks with an adjacent section by means of a ball/socket (bowl) union. The connection (union) may initially be a pathway for ground-water migration which may abate or cease if the ball/socket section is naturally or artificially filled with impermeable material. Sections of pilings are assembled before being driven into the ground (soil conditions permitting).

a. Description.

(1) Various sheet piling configurations are available. Application of specific configurations and fittings can be used for site-specific needs such as partitioning different sections of a waste-contaminated area or combination

of areas. Piling weight may vary from 1054 to 1820 Pa (22 to 38 lb/ft²) depending upon the driving depth and soil materials.

(2) Keying in to a subsurface impermeable barrier is limited by depth to the barrier and composition of the barrier. Pile driving to a relatively shallow clay deposit and keying in to the clay without driving completely through the clay is relatively common in construction practices. However, keying in to a rock unit such as shale or other sedimentary unit is difficult. The physical tightness of such a bedrock/piling key is poor and may require additional sealing (grout, etc.). Pile testing and borings to an impermeable horizon can be used to determine the effectiveness of the barrier and piling interlock (ball/socket) damage.

b. Applications.

(1) As a remedial action at a hazardous waste site, sheet piling cutoff walls can be used to contain contaminated ground water. Piling driven to an impermeable layer can retain an existing contaminant(s) that may be released during cleanup actions.

(2) If ground-water flow rates and volume moving toward a hazardous waste site are sufficient to potentially transport a contaminant plume or impede site cleanup operations, a piling barrier can be used to divert the ground-water flow.

(3) Installation of sheet pilings at a hazardous waste site may present special problems related to buried tanks or drums that may be ruptured, unless care is taken to investigate the proposed piling alignment with magnetometers or other metal-locating devices. Drums at depth may not be detected and pose special problems.

c. Design and Construction.

(1) Maximum effective depth is considered to be 14.9 m (49 feet). Although under ideal conditions, pile sections have been driven up to depths of 29.9 m (98 feet).

(2) Steel sheet piling is most frequently used. Concrete and wood have also been used. Concrete is expensive but is attractive when exceptional strength is required, and, although less expensive, wood is relatively ineffective as a water barrier.

(3) Sheet piles are typically used in soils that are loosely packed, and predominantly sand and gravel in nature. A penetration resistance of 13 to 33 blows/m (4 to 10 blows/foot) for medium- to fine-grained sand is recommended. Cobbles and boulders can hinder pile placement.

(4) Piling lifetime depends on waste characteristics and pile material. For steel piles pH is of particular importance. A pile life up to 40 years (depending on other leachate characteristics) can be expected where pH ranges between 5.8 and 7.8. A pH as low as 2.3 can shorten the lifetime to 7 years or less.

d. Advantages and Disadvantages.

(1) Sheet pilings require no excavation. Thus, the construction is relatively economical. In most cases, no maintenance is required. The disadvantages of sheet pilings are the lack of an effective seal between pilings and problems related to piling corrosion.

(2) At hazardous waste sites, corrosion of sheet pilings can be a severe problem. Many sites contain mineral acids that react readily with iron. Standard cathodic protection may not be effective if local concentrations of acid materials are present. Any reaction of metal with acid can produce hydrogen gas that may diffuse from the soil and create a fire or explosion hazard at the surface.

3-19. Membranes and Synthetic Sheet Curtains. Membranes and other synthetic materials have been used extensively as pond and lagoon liners. The impervious nature of the liner and its general resistance to corrosive chemicals have been proven to exceed the qualities typical of clay liner material used in landfills. The key factor in the use of membrane liners is to produce an effective seal between adjacent sheets of membrane.

a. Description. Synthetic membrane materials (PVC, butyl rubber, polyethylene) may be used in a manner similar to clay or sheet pile cutoff walls. The membrane can be inserted in a slit or a V-shaped trench to facilitate anchoring at the top of the trench. Membrane liners require some special handling for effective use. Membrane materials are usually not laid with any stress on the membrane. All seams are heat- or solvent-welded using manufacturer-approved techniques to ensure the seams are as strong as the material itself.

b. Applications. Membrane curtains can be used in applications similar to grout curtains and sheet piling. The membrane can be placed in a trench surrounding or upgradient (ground water) from the specific site, thereby enclosing the contaminant or diverting the ground-water flow. Placing a membrane liner in a slurry trench application has also been tried on a limited basis.

c. Compatibility. Compatibility of the membrane material with contaminated ground water or soil should be considered before emplacement of the membrane.

d. Design and Construction. Emplacement of the liner in conventional style requires a trench of sufficient size and slope that crews can lay the liner and transverse the liner with sealing equipment. The trench needs to be excavated to an impervious zone wherein the membrane is keyed in and sealed to prevent leakage at the membrane bottom. In conditions of contaminated, unstable, or saturated soils, special safety and construction practices must be established. Lowering a prepared liner into a narrow vertical trench is not feasible. The narrow trench in most cases will not be able to remain open without caving debris interfering with keying in conditions. Suspending the lines may cause stretching or tearing.

e. Advantages and Disadvantages.

(1) The membrane provides an effective barrier if it can be emplaced without puncture or imperfect sealing. Sealing is a difficult process that requires material handling and manipulation not afforded by trench emplacement. Keying the membrane adequately to the impervious layer is also difficult. The key zone must be disturbed and membrane material may not be conducive to adhering to concrete or other sealing material.

(2) Installation of liners is also restricted to climatic conditions. Liner membranes generally should not be installed at temperatures colder than about 45°F. Soil temperature as well as atmospheric temperatures affect the flexibility as well as sealing character of the membrane. Adverse moisture conditions also may inhibit successful sealing of seams.

3-20. Combination Barrier/Pumping Systems. Barrier and pumping systems can be used in combination to ensure containment of contaminated ground water. When used in combination, the general approach is to use the barrier system to minimize the quantity of ground water that must be pumped and treated. The most common application of a combination barrier/pumping system is the use of a circumferential slurry wall, keyed into an underlying aquiclude, combined with an interior pumping system to maintain an inward hydraulic gradient. Design criteria are similar to those previously discussed for the individual systems.

3-21. Subsurface Drains and Drainage Ditches.

a. Background.

(1) Subsurface French drains are trenches filled with gravel that are used to manage surface or ground-water flows in shallow subsurface materials. At most hazardous waste sites, standard French drains are of limited use because close control of ground-water flow is required, and care must be exercised in preventing contaminated water from reaching lower aquifers.

(2) Well-designed underdrains that can intercept ground water flowing into a waste site have been helpful in reducing the water treatment problem where extraction systems are employed. Where the water table is relatively shallow (30 feet below the surface or less), a waste site can be isolated by trenching down into the water table and introducing a barrier and a vertical permeable layer with a drain at the bottom. This system acts to intercept small springs or seepage that may enter a buried waste pit. By diverting the ground water before it enters the site, the growth of the pollution plume exiting the site is reduced without pumping.

(3) When applicable, the barrier/underdrain system is a permanent low-cost remedial option. It requires small maintenance efforts to ensure the drains are clear. The intercepted ground water is usually tested periodically to ensure that no pollutant is discharged. The only disadvantages observed with this system relate to possible movement of contaminant through the ground-water barrier and into the drains. If this occurs, all of the discharge from the underdrains may require treatment before discharge. This

problem can be minimized by having the system built in unconnected segments with separate outfalls.

b. Applications.

(1) Subsurface drains can be used to intercept leachate or infiltrating water in any clay or silty clay soil where the permeability is not adequate to maintain sufficient flow and at sites where the leachate is not too viscous or gummy to prevent flow to the drains. Other conditions, such as a deep frost zone, may also restrict the use of underdrains in certain soils.

(2) Drainage ditches can be an integral part of a leachate collection system in that they may be used as collectors for surface water runoff, collectors leading from subsurface drains, or as interceptor drains.

(3) Surface drainage may be essential for flat or gently rolling landfills underlain by impermeable soils where subsurface drainage may be impractical or uneconomical.

(4) Open ditches may be used as interceptor drains to collect lateral surface seepage, thus preventing it from percolating into ground water or flowing laterally to an area that should be protected. The choice between using an open drain or subsurface drain depends upon the slope of the flow. For steep slopes, open drains are generally more desirable. An open ditch may be used in certain circumstances to intercept subsurface collectors and carry the leachate to its ultimate disposal.

(5) Drains or trenches may be useful in collecting contaminants floating on the ground-water surface. Where the ground water is shallow, and the slope adequate, drains may be more economical and effective than extraction wells.

c. Design and Construction Considerations.

(1) Subsurface drains.

(a) Subsurface leachate collection systems (Figure 3-22) have been proposed or constructed at several existing landfills. The drainage systems are generally constructed by excavating a trench and laying tile or pipe sections end to end in strings along the bottom. The trench is then backfilled with gravel or other envelope material to a designated thickness; the rest of the trench is then backfilled with soil. Often the gravel is lapped with geotextile fabric to prevent fine soil from entering the gravel and clogging the drain. The front view of a subsurface leachate collection system is illustrated in Figure 3-23.

(b) In some instances, gravel-packed wet wells may be used. Wells are constructed similarly to trenches.

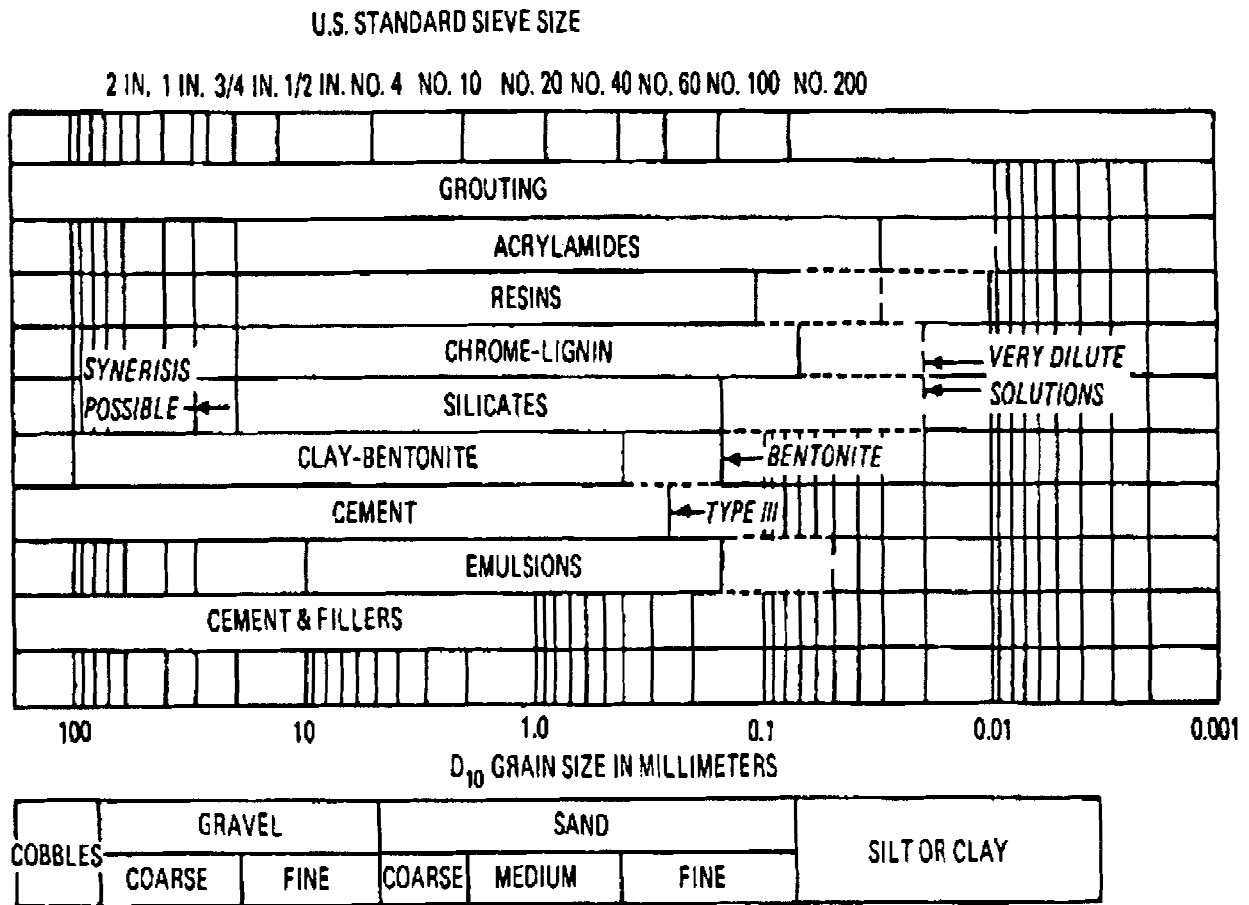

DASHED LINES REPRESENT EXTREME LIMITS OF APPLICATION AS REPORTED IN THE LITERATURE; SOLID LINES APPLY TO MORE TYPICAL APPLICATIONS

Figure 3-22. Subsurface Leachate Collection (Source: EPA 1979)

(c) An impermeable liner may be required on the downgradient end of the subsurface drain to prevent flow-through of intercepted and contaminated ground water if the surrounding materials have a moderate to high permeability.

(d) The major design problem for subsurface drains is to determine the optimum spacing, depth, and hydraulic capacity. Determination of these criteria is usually based on practical experience, experimental data, and calculations using drainage formula. Spacing between drain lines and wet wells depends upon the depth of the drain below the surface, the hydraulic conductivity of the soil, the amount of subsoil to be drained, and the potential for constructing underdrains beneath the landfill. Orientation of the trenches perpendicular to the flow lines would make spacing irrelevant, provided the trenches capture the flow at all required depths.

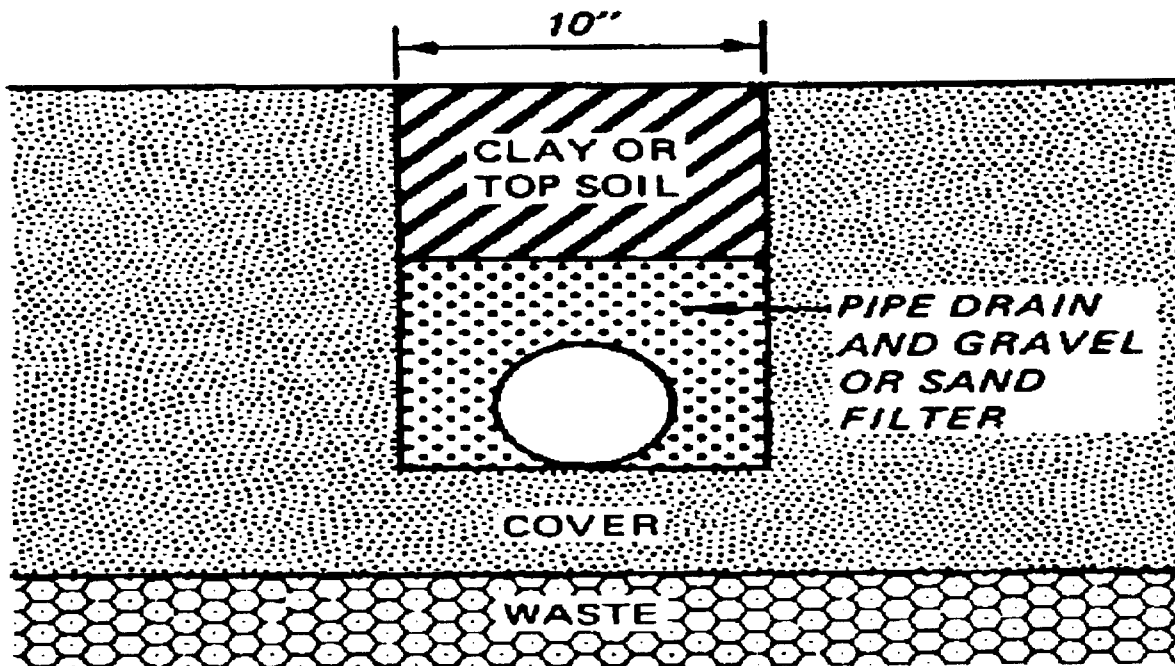

Figure 3-23. Typical Design Plan for Leachate Collection System

(e) Design equations that have been developed for flow to a drainage pipe indicate that a greater depth allows for wider spacing. These formulae are considered in relation to spacing. The simplest formula for estimating drain spacing assumes homogeneous soils and one-dimensional flow. Drain spacing can be estimated from Hooghoudt's formula as follows:

$$S = \frac{4K}{Q} [(D + H)^2 - (D + h)^2] \quad (3-1)$$

where

S = drain spacing, m (feet)

k = hydraulic conductivity, m/day (feet/day)

Q = design flow to the drain, m³/day/m of ditch (cubic feet per day per foot)

D = depth of flow layer beneath the drains, m (feet)

H = height of ground-water table above the plane through the drains and midway between two drains, m (feet)

h = height of water level in the drain, m (feet)

(f) The cone of depression observed around a well becomes a trough along the line of the drain. The spacing of the drains must be such that the water table at its highest point between drains intercepts all leachate-generating wastes, and does not interfere with plant growth or zone of aeration, if these factors play a part in proper operation of the fill.

(g) In actual practice, spacing of underdrains may be restricted by the boundaries of waste in such a way that the composite cones of depression of the drains do not completely overlap and some leachate escapes the collection system. This may occur where ideal spacing requires that underdrains be constructed beneath a waste site. Since the drain spacing is influenced by depth and hydraulic conductivity, it may be possible to increase spacing and still intercept all leachate by increasing drain depth and by adjusting envelope thickness to increase hydraulic conductivity so that underdrains beneath the site are not necessary.

(h) Horizontal drilling is now available without the need to jack or drill from a pit. This drilling technique allows drilling to start from the surface (at an oblique angle) and then turn horizontal at a certain depth. Though limited to depths of greater than about 6.1 m (20 feet), this technology shows promise for placing drains under landfills, lagoons, and tanks.

(i) Minimum grade or slope is determined on the basis of site conditions and size of the drains. Some designers wish to specify a minimum velocity rather than a minimum grade. It is generally desirable to have a slight slope in order to obtain a velocity sufficient to clean the drain during discharge and to speed up emptying of a drain after a discharge period. Slopes of about 0.1 percent can be obtained with present trench digging equipment accurate to within 1 centimeter of the prescribed depth.

(j) Drains have a relatively small area of inflow, causing an entrance resistance. Failures of tube drains are often due to the high resistance of approach of the envelope material and soil; the type of tube is usually less critical. Application of the proper envelope material in sufficient quantities can significantly reduce the effect of resistance. The most commonly used envelope materials include sand and fine gravel, and to a lesser extent straw, woodchips, and fiberglass. Recommendations for drain envelope thickness have been made by various agencies. The Bureau of Reclamation recommends a minimum thickness of 10 centimeters around the pipe, and the Soil Conservation Service recommends a minimum of 8 centimeters for agricultural drains. In actual practice, much thicker envelopes may be used to increase hydraulic conductivity. An 203 mm (8-inch-diameter) perforated pipe used for leachate collection at Love Canal is surrounded with about 0.61 m (2 feet) of gravel.

(k) After the trench is backfilled with the appropriate thickness of envelope material, it may be desirable to wrap the gravel with a fabric to prevent clogging of the gravel and drains with soil. One such available material is Tyvar, a strongly woven fabric that allows liquids to pass through but prevents soil from getting into the pipeline.

(1) The design and construction of leachate collection systems can be exemplified by the Love Canal (Figure 3-24). The heart of the collection system at Love Canal is a series of drains with 152 to 203 mm (6- to 8-inch-diameter) perforated, vitrified clay pipe backfilled with about 2 feet of gravel envelope. The ditches run roughly parallel along the north and south borders of the canal, as shown in Figure 3-24. The trenches are approximately 3.7 m (12 feet) below grade, dropping to a maximum of 4.6 m (15 feet). With a gradient of 0.5 percent, they empty leachate into precast concrete wet wells. Leachate is pumped from wet wells by vertical submersible pumps to an 203 mm (8-inch-diameter) gravity main, from which it descends into concrete holding tanks. Drains of different elevations are connected by manholes. To hasten dewatering from the canal, lateral trenches have also been dug between the canal boundaries and the main drainage system.

(2) Drainage ditches.

(a) Open ditches are on the order of 1.8 to 3.7 m (6 to 12 feet) deep. When they are connected to subsurface drains, they must be deep enough to intercept the underdrains.

(b) The water level in a ditch is determined by the purpose the ditch has to serve. Surface drains require sufficient freeboard when running at full capacity. The flow velocity should be kept within certain limits in view of scouring of the bed and side slopes and of sediment deposition. Important factors governing the desired flow velocity are soil type, type of channel,

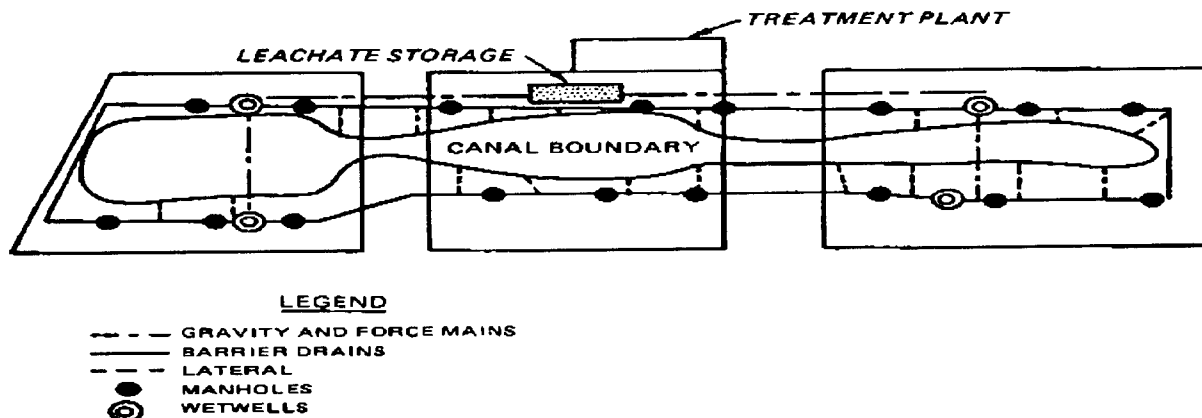

Figure 3-24. Leachate Collection System for Love Canal, Transverse View (Source: Glaubinger et al. 1979)

Reprinted by special permission from CHEMICAL ENGINEERING (1979) Copyright (c) 1979, by McGraw-Hill, Inc., New York, NY 10020.

well roughness, and sediment load. The size of the ditch necessary to carry the estimated quantity of water can be determined from the Manning velocity equation and is dependent upon the slope, depth, and shape of its cross section.

(c) The selection of side slopes is based on stability of soil and on the hazard of scour, taking into account possible ground-water pressures and vegetative cover. The stability of side slopes may be improved by tamping or rolling. Trapezoidal cross sections are generally most efficient. In fine-grained soils such as heavy clays, $\frac{1}{2}$ to 1 slopes (0.15 to 0.3 m (0.5 foot to 1 foot vertical)) and 1-1/2 to 1 are common. In coarser textured soils, 1 to 1 or 2 to 1 may be advisable.

(d) Ditch bottoms at junctions should be at the same elevation to avoid drops that may cause scour. Right-angle junctions encourage local scour of the bank opposite the tributary ditch, and the smaller ditch should be designed to enter the larger at an angle of about 30 degrees. The scour will also occur at sharp changes in ditch alignment, so long radius curves should be used where change is necessary.

(e) An open ditch can be kept in efficient working condition by careful maintenance. A drain allowed to become obstructed by brush, weed growth, or sediment can no longer be efficient; it should be cleaned to its original depth when efficiency is curtailed.

d. Advantages and Disadvantages. The advantages and disadvantages of subsurface drains and drainage ditches are summarized below:

<u>Advantages</u>	<u>Disadvantages</u>
<u>Subsurface Drains</u>	
Operation costs are relatively cheap since flow to underdrains is by gravity	Not well suited to poorly permeable soils
Provides a means of collecting leachate without the use of impervious liners	In most instances it will not be feasible to situate underdrains beneath the site
Considerable flexibility is available for design of underdrains; spacing can be altered to some extent by adjusting depth or modifying envelope material	System requires continuous and careful monitoring to ensure adequate leachate collection
Systems fairly reliable, providing there is continuous monitoring	

(Continued)

Advantages

Disadvantages

Drainage Ditches

Low construction and operating cost	Requires extensive maintenance to maintain operating efficiency
Useful for intercepting landfill side seepage and runoff	Generally not suited for deep disposal sites or impoundments
Useful for collecting leachate in poorly permeable soils where sub-surface drains cannot be used	May interfere with use of land May introduce need for additional safety/security measures
Large wetted perimeter allows for high rates of flow	

Section III. Surface Water Controls

3-22. Surface Water Diversion.

a. Background.

(1) A major consideration at any hazardous waste site is water management. Minimizing the amount of water moving through a site reduces the spread of potentially toxic materials and the requirements to treat leachate or drainage from the area. Many sites are in low-lying areas adjacent to natural watercourses. In some instances, it has been necessary to divert drainage around a landfill or reinforce or dike streambanks to prevent the waste from being washed into the stream and contaminating the water downstream. Run-on is generally controlled using ditching, channelization, or construction of berms and dikes.

(2) Run-on diversion can be implemented at a hazardous waste site by using many of the same remedies used to control run-on at a construction site. This remedial activity is applicable when it can be demonstrated that water is entering the disposal site from adjacent slopes or that streams moving across the site are contributing water to the site or washing wastes out of the site.

(3) Where minimizing ground-water infiltration is important to prevent the water table under the site from rising, lined trenches should be considered in drainage design. Lined trenches typically are constructed of concrete, shotcrete, asphaltic concrete, metal culvert (half sections), or synthetic membrane materials (polyvinylchloride or polyethylene).

(4) The data requirements for design of drainage systems on or around a hazardous waste system are similar to those required for construction drainage, including area to be drained, type of drain proposed, grade of the proposed drainway, and maximum capacity based on rainfall and snowmelt records. Additional considerations would be the lifetime of the system. Some systems will be required only until wastes can be excavated and transported;

at other sites, the waste will remain in place, and the surface water control system will have to be maintained indefinitely.

(5) Design criteria for drainage systems at landfills are not specifically provided in regulations. The performance requirements are for most complete diversion of water possible. The Department of Agriculture and EPA guidance for sizing diversion drainage systems around a waste disposal area calls for carrying capacities equal to at least the peak run-off from a 10-year, 24-hour storm. In most cases, carrying capacities should be greater.

(6) Design procedures are typically undertaken in much the same way as those for drainage or diversion planning--from estimation of carrying capacity requirements to specific requirements as to the type of drainage and specific types of material (sod, riprap, concrete, etc.) to be employed. Models, such as Storage Treatment Overflow and Run-off Model (STORM) from the Corps* Hydrologic Engineering Center (HEC), Chemical Runoff and Erosion from Agricultural Management Systems Hydrologic Model (CREAMS) from the Department of Agriculture, and Hydrologic Evaluation of Landfill Performance (HELP) from the Corps* Waterways Experiment Station can be helpful in determining the quantity and quality of run-off from areas surrounding a waste site. Several well-established construction techniques are available for diverting and handling surface water flow in critical areas. Those methods most applicable as remedial measures at uncontrolled disposal sites are addressed below.

b. Dikes and Berms.

(1) Description and applications.

(a) Dikes and berms are well-compacted earthen ridges or ledges constructed immediately upslope from or along the perimeter of disturbed areas (e.g., disposal sites). These structures are generally designed to provide short-term protection of critical areas by intercepting storm run-off and diverting the flow to natural or man-made drainageways, to stabilized outlets, or to sediment traps. The terms "dikes" and "berms" are generally used interchangeably; however, dikes may also have applications as flood containment levees.

(b) Dikes and berms may be used to prevent excessive erosion of newly constructed slopes until more permanent drainage structures are installed or until the slope is stabilized with vegetation. Dikes and berms will help provide temporary isolation of uncapped and unvegetated disposal sites from surface run-off that may erode the cover and infiltrate the fill. These temporary structures are designed to handle relatively small amounts of runoff; they are not recommended for unsloped drainage areas larger than 5 acres.

(2) Design and construction considerations.

(a) Specific design and construction criteria for berms and dikes will depend upon desired site-specific functions of the structures. An interceptor dike/berm may be used solely to shorten the length of exposed slopes on or above a disposal site, thereby reducing erosion potential by intercepting and

diverting run-off. Diversion dikes/berms may be installed at the top of the steeper side slopes of unvegetated disposal sites to provide erosion protection by diverting runoff to stabilized channels or outlets.

(b) Dikes and berms ideally are constructed of erosion-resistant, low-permeability, clayey soils. Compacted sands and gravel, however, may be suitable for interceptor dikes and berms. The general design life of these structures is on the order of one year maximum; seeding and mulching or chemical stabilization of dikes and berms may extend their life expectancy. Stone stabilization with gravel or stone riprap immediately upslope of diversion dikes will also extend performance life.

(c) All earthen dikes should be machine compacted. In addition:

! Diverted runoff should discharge directly onto stabilized areas, grassed channel, or chute/downpipe.

! Periodic inspection and maintenance should be provided.

! Diversion dikes must be seeded and mulched immediately after construction.

(3) Advantages and disadvantages. Advantages and disadvantages of dikes and berms are summarized below:

<u>Advantages</u>	<u>Disadvantages</u>
Uses standard construction techniques and equipment usually already on site	Periodic inspections and maintenance required to ensure structural integrity
Required fill dirt usually available on site	May increase seepage if installed improperly, increasing soil instability and leachate generation
Temporary control of erosion until further stabilization	Only suitable for small drainage areas (less than 2 hectares (5 acres))
Runon water reduced, and therefore leachate production	

c. Ditches, Diversions, and Waterways.

(1) Description and applications.

(a) Ditches (or swales) are excavated, temporary drainageways used above and below disturbed areas to intercept and divert runoff. They may be constructed along the upslope perimeter of disposal areas to intercept and carry storm run-off into natural drainage channels downslope of the site. Ditches may also be installed downslope of covered disposal sites to collect and transport sediment-laden flow to sediment traps or basins. Ditches should

be left in-place until the disposal site is sealed and stabilized with cover vegetation.

(b) Diversions are permanent or temporary shallow drainageways excavated along the contour of graded slopes and having a support earthen ridge (dike or berm) constructed along the downhill edge of the drainageway. Essentially, a diversion is a combination of a ditch and a dike. Diversions are used primarily to provide more permanent erosion control on long slopes subject to heavy flow concentrations. They may be constructed across long slopes to divide the slope into nonerosive segments. Diversions may also be constructed at the top or at the base of long graded slopes at disposal sites to intercept and carry flow at nonerosive velocities to natural or prepared outlets. Diversions are recommended for use only in slopes of 15 percent or less.

(c) Grassed waterways (or channels) are graded drainageways that serve as outlets for diversions or berms. Waterways are stabilized with suitable vegetation and are generally designed to be wide and shallow in order to convey run-off down slopes at nonerosive velocities. Waterways may be constructed along the perimeter of disposal sites located within natural slopes, or they may be constructed as part of the final grading design for disposal areas that have been capped and revegetated.

(2) Design and construction considerations.

(a) Ditches, diversions, and waterways are generally of V-shaped, trapezoidal, or parabolic cross-section design. The specific design will be dependent on local drainage patterns, soil permeability, annual precipitation, area land use, and other pertinent characteristics of the contributing watershed. In general, such drainageways should be designed to accommodate flows resulting from rainfall events (storms) of 10- or 25-year frequency. More importantly, they should be designed and constructed to intercept and convey such flows at nonerosive velocities.

(b) Figure 3-25 depicts the effect of drainage channel shape on relative velocity of conveyed flows. In general, the wider and shallower the channel cross section, the less the velocity of contained flow and therefore the less the potential for erosion of drainageway side slopes. Where local conditions dictate the necessity of building narrower and deeper channels, or where slopes are steep and flow velocities are excessive, the channel will require stabilization through seeding and mulching or the use of stone riprap to line channel bottoms and break up flow.

(c) Table 3-6 presents maximum permissible design velocities for flow in ditches and grassed waterways, based on the channel grade and stabilizing cover material.

(d) These structures are designed for short-term application only, for upslope drainage areas of less than 2 hectares (5 acres). A minimum grade of 1 percent, draining to a stabilized outlet such as a grassed waterway or, where necessary, to a sediment basin or trap, is recommended for temporary ditches. For channel slopes greater than 5 percent, stabilization with

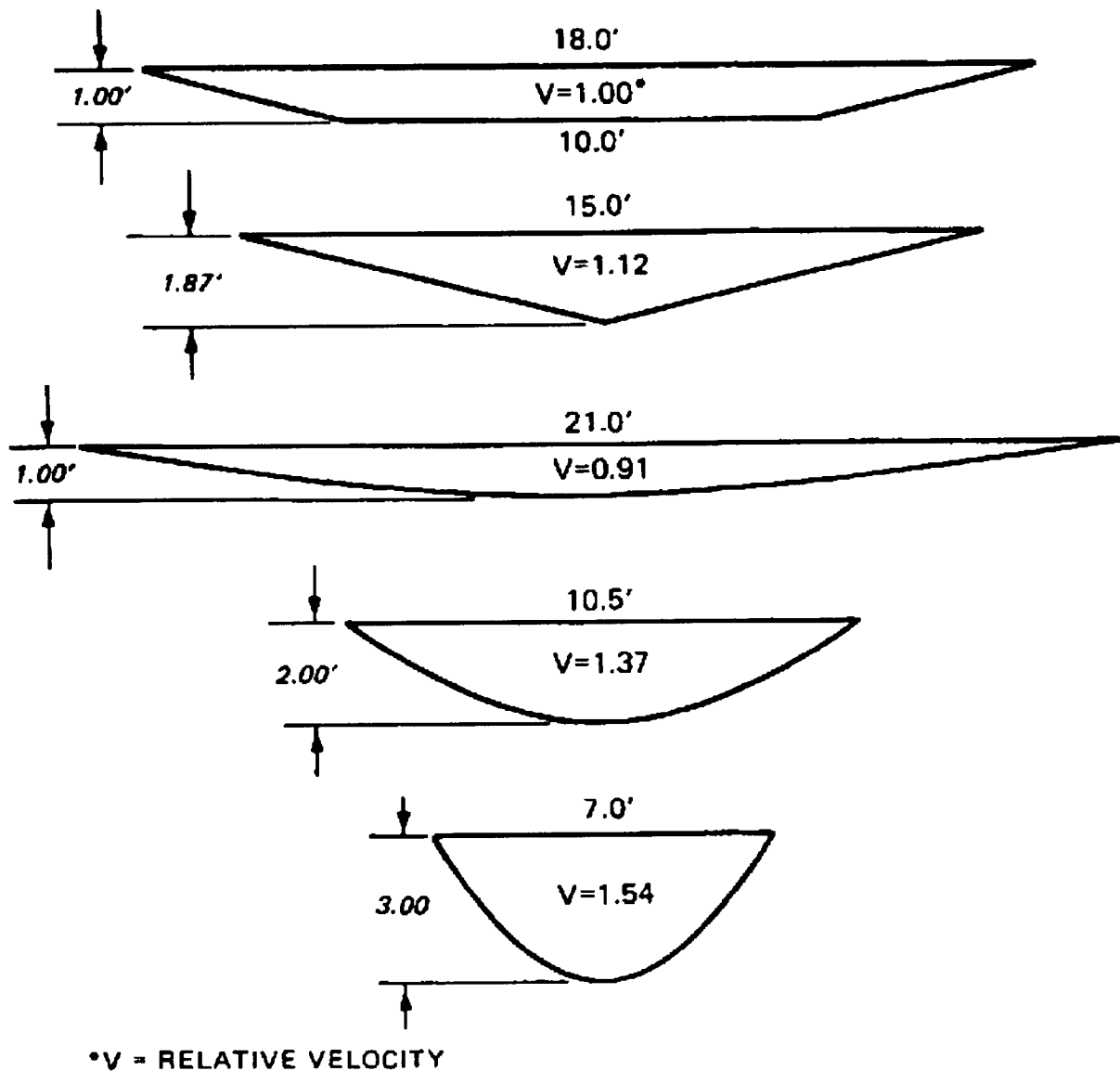

Figure 3-25. Effect of Drainage Ditch on Velocity

grasses, mulches, sod, or stone riprap will be necessary. As with all temporary structures, periodic inspection and maintenance are required to ensure structural integrity and effective performance.

(e) Figure 3-26 presents general design features of parabolic and trapezoidal diversions. A formal design is not required for diversions used as temporary water-handling structures. General design and construction criteria for permanent diversions and waterways include the following:

Table 3-6. Permissible Design Velocities for Stabilized Diversions and Waterways

Vegetation	Maximum design velocity		
	Channel grade (%)	(ft/sec)	(m/sec)
Bermuda grass	0-5	6	1.8
	5-10	5	1.5
	10	4	1.2
Reed canary grass	0-5	5	1.5
Tall fescue	5-10	4	1.2
Kentucky bluegrass	10	3	0.9
Grass-legume mix	0-5	4	1.2
	5-10	3	0.9
Red fescue	0-5	2.5	0.8
Redtop, sericea lespedeza			
Annuals; small grain (rye, oats, barley); ryegrass	0-5	2.5	0.8

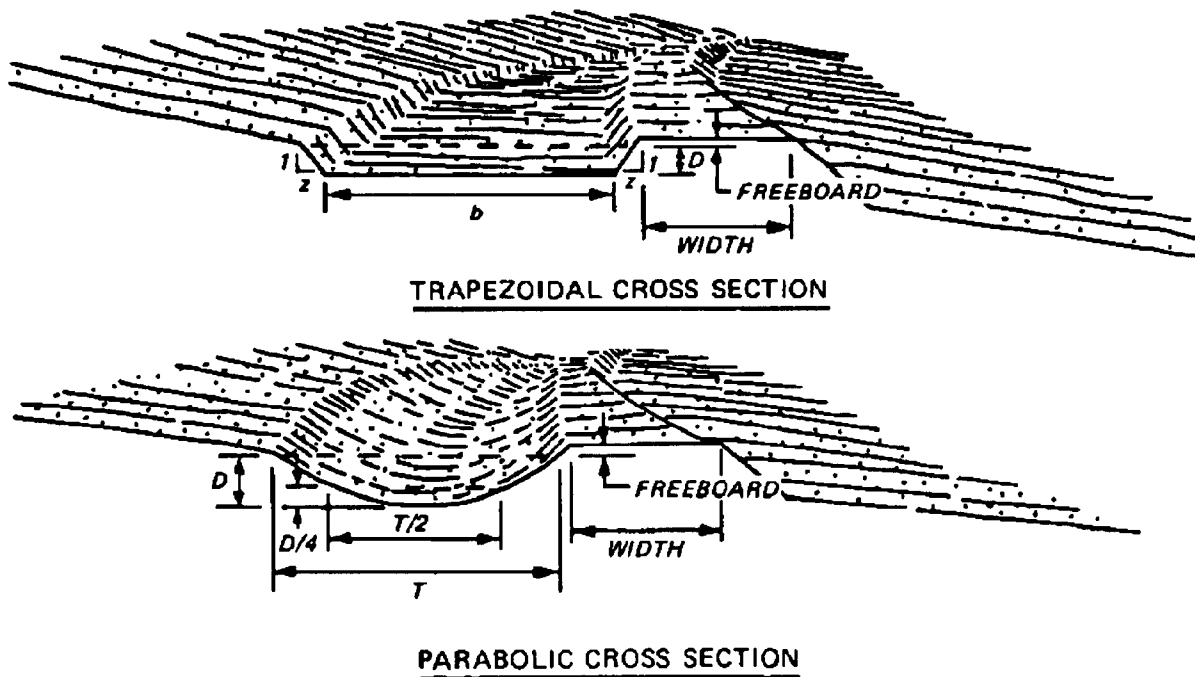

Figure 3-26. General Design Features of Diversions

! Diversion location will be determined on the basis of outlet conditions, topography, soil type, slope length, and grade.

! Constructed diversion will have the capacity to carry peak discharge from the 25-year design storm.

! The maximum grade of the diversion may be determined by using design velocity of the flow based on stabilization by cover type (Table 3-6).

! The diversion channel will be parabolic or trapezoidal in shape, with side slopes no steeper than 2:1.

! Each diversion will have a stable outlet such as a natural waterway, stabilized open channel, chute, or downpipe.

! For channels that carry flow during dry weather (base flow) due to ground-water discharge or delayed subsurface run-off, the bottom should be protected with a stone center for grassed waterways. Subsurface drainage with gravel/stone trenches may be required where the water table is at or near the surface of the channel bottom.

(3) Advantages and disadvantages.

(a) When they are carefully designed, constructed, and maintained, ditches, diversions, and grassed waterways will control surface erosion and infiltration at disposal sites by intercepting and safely diverting storm run-off to downslope or offsite outlets. When situated at the base of disposal site slopes, they function to protect offsite habitat from possible contamination by sediment-laden run-off. These structures are generally constructed of readily available fill, by well-established techniques.

(b) Temporary ditches and diversions, however, entail added costs because they require inspections and maintenance. Grassed waterways must be periodically mowed to prevent excessive retardation of flow and subsequent ponding of water. Also, periodic resodding, remulching, and fertilizing may be required to maintain vegetated channels.

(c) If fertilization is used, an additional disadvantage is introduced in that nitrogen and phosphorus are added to drainage wastes, which then contribute to the problem of accelerated eutrophication in receiving water bodies.

(d) It may also be necessary to install temporary straw-bale check dams, staked down at 15.2 to 30.5 m (50- to 100-foot) intervals, across ditches and waterways in order to prevent gulley erosion and to allow vegetative establishment.

(e) Permanent diversions and waterways are more cost-effective techniques than temporary structures for controlling erosion and infiltration on a long-term basis at inactive disposal sites.

d. Terraces and Benches.

(1) Description and applications.

(a) Terraces and benches are relatively flat areas constructed along the contour of very long or very steep slopes to slow run-off and direct it into ditches or diversions for offsite transport at nonerosive velocities. These structures are also known as bench terraces or drainage benches.

(b) Although benches and terraces are slope-reduction devices, they are generally constructed with reverse or natural fall to divert water to stabilized drainageways. Benches and terraces may be used to break up steeply graded slopes of covered disposal sites into less erodible segments. Upslope of disposal sites, they act to slow flow and divert storm run-off around the site. Downslope of landfill areas, they act to intercept and divert sediment-laden run-off to traps or basins. Hence, they may function to hydrologically isolate active disposal sites, to control erosion of cover materials on completed fills, or to collect contaminated sediments eroded from disposal areas. For disposal sites undergoing final grading (after capping and prior to revegetation), construction of benches or terraces may be included as part of the integrated site closure plan.

(2) Design and construction considerations.

(a) Benches and terraces generally do not require a formal design plan. Figure 3-27 presents the design for a typical drainage bench located on the slope of a covered landfill. This particular bench is designed with a natural fall. It is intended for long-term erosion protection as the associated V-shaped channel is asphalt-concrete lined. Diversions and ditches included in bench/terrace construction may be seeded and mulched, sodded, stabilized with riprap or soil additives, or stabilized by any combination of these methods. Lining the channels with concrete or grouted riprap is a more costly alternative.

(b) The width and spacing between benches and terraces will depend on slope steepness, soil type, and slope length. In general, the longer and more erodible the cover soil, the less the distance between drainage benches should be. For slopes greater than 10 percent in steepness, the maximum distance between drainage benches should be approximately 30.5 m (100 feet), i.e., a bench every 3 m (10 feet) of rise in elevation.

(c) When the slope is greater than 20 percent, benches should be placed every 20 feet of rise in elevation. Benches should be of sufficient width and height to withstand a 24-hour, 25-year storm.

(d) Bench terraces do not necessarily have to be designed with diversions or ditches to intercept flow. Reverse benches and slope benches may be constructed during final site grading on well-stabilized slopes (e.g., vegetated) to enhance erosion control by reducing slope length and steepness. At sites where an effective cap (e.g., clay or synthetic liner) has been constructed, or for sites located in arid regions, these nondrainage benches

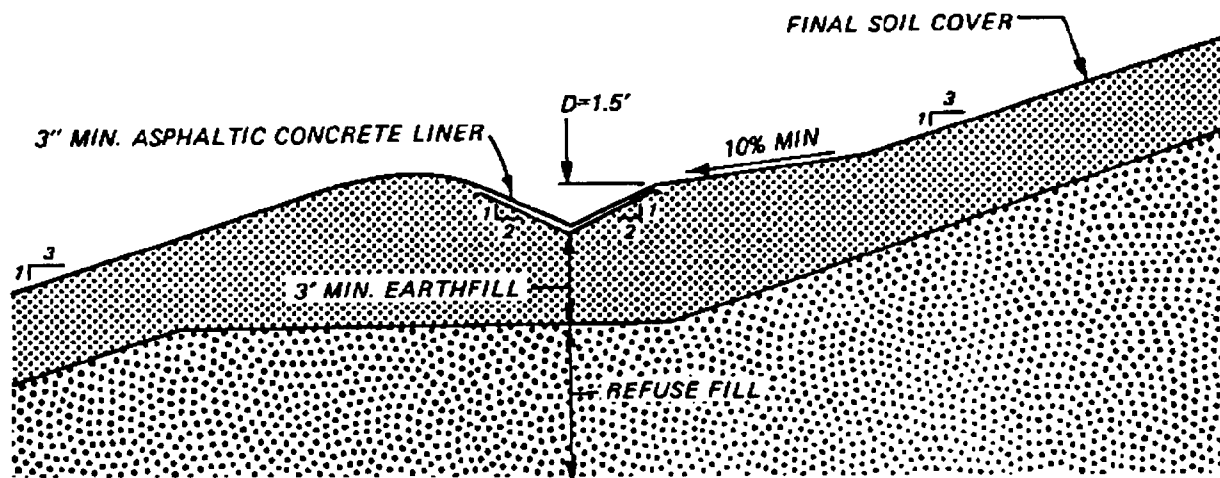

Figure 3-27. Typical Drainage Bench

will function to slow sheet run-off and allow greater infiltration rates, which will aid in the establishment of a suitable vegetative cover. For most disposal sites in wet climates, however, where leachate generation and cover erosion are major problems, benches and terraces should be designed in association with drainage channels that intercept and transport heavy, concentrated surface flows safely offsite.

(e) As with other earthen erosion control structures, benches and terraces should be sufficiently compacted and stabilized with appropriate cover (grasses, mulches, sod) to accommodate local topography and climate. They should be inspected during or after major storms to ensure proper functioning and structural integrity. If bench slopes become badly eroded or if their surfaces become susceptible to ponding from differential settlement, regrading and sodding may be necessary.

(3) Advantages and disadvantages.

(a) In areas of high precipitation, drainage benches and terraces are proven effective in reducing velocity of storm run-off and thereby controlling erosion. For excessively long and steep slopes above, on, or below disposal sites, these structures are cost-effective methods for slowing and diverting run-off. They may also be used to manage downslope washout of disposal site sediments that may be contaminated with hazardous waste components. Terraces and benches are easily incorporated into final grading schemes for disposal sites and do not require special equipment or materials for their construction.

(b) If improperly designed or constructed, bench terraces will not perform efficiently and may entail excessive maintenance and repair costs. It is important that these structures be stabilized with vegetation as soon as possible after grading and compaction, or they may become badly eroded and

require future resodding or chemical stabilization. Benches and terraces also require periodic inspections, especially after major rainfall events.

e. Chutes and Downpipes.

(1) Description and applications.

(a) Chutes and downpipes are temporary structures used to carry concentrated flows of surface runoff from one level to a lower level without erosive damage. They generally extend downslope from earthen embankments (dikes or berms) and convey water to stabilized outlets located at the base of terraced slopes.

(b) Chutes (or flumes) are open channels, normally lined with bituminous concrete, portland cement concrete, grouted riprap, or similar nonerrodible material. Temporary paved chutes are designed to handle concentrated surface flows from drainage benches located near the base of the long, steep slopes at disposal sites.

(c) Downpipes (downdrains or pipe slope drains) are temporary structures constructed of rigid piping (such as corrugated metal) or flexible tubing of heavy-duty fabric. They are installed with standard prefabricated entrance sections and are designed to handle flow from drainage areas of 5 acres or less. Like paved chutes, downpipes discharge to stabilized outlets or sediment traps. Downpipes may be used to collect and transport run-off from long, isolated outslopes or from small disposal areas located along steep slopes.

(2) Design and construction considerations.

(a) Chutes and downpipes are temporary structures that do not require formal design.

(b) Paved chute construction considerations include the following:

! The structure will be placed on undisturbed soil or well-compacted fill.

! The lining will be placed by beginning at the lower end and proceeding upslope; the lining will be well compacted, free of voids, and reasonably smooth.

! The cutoff walls at the entrance and at the end of the asphalted discharge aprons will be continuous with the lining.

! An energy dissipator (riprap bed) will be used to prevent erosion at the outlet.

(c) For downpipes, the maximum drainage area will be determined from the diameter of the piping, as follows (U.S. EPA 1976):

<u>Pipe/Tube diameter, D</u>		<u>Maximum drainage area</u>	
<u>(inches)</u>	<u>(mm)</u>	<u>(acres)</u>	<u>(hectares)</u>
12	300	0.5	0.2
18	460	1.5	0.6
21	530	2.5	1
24	610	3.5	1.4
30	760	5.0	2

(d) General construction criteria for both rigid and flexible downdrains include the following:

! The inlet pipe will have a slope of 3 percent or greater.

! For the rigid downpipe, corrugated metal pipe with watertight connecting bands will be used.

! For the flexible downdrain, the inlet pipe will be corrugated metal; the flexible tubing will be the same diameter as the inlet pipe, securely fastened to the inlet with metal strapping or watertight connecting collars.

! A riprap apron of 152 mm (6-inch-diameter) stone will be provided at the outlet.

! The soil around and under the inlet pipe and entrance sections will be hand-tamped in 102 mm (4-inch) lifts to the top of the earth dike.

! Follow-up inspection and any needed maintenance will be performed after each storm.

(3) Advantages and disadvantages. The advantages and disadvantages associated with the construction and maintenance of chutes and downpipes are summarized below:

<u>Advantages</u>	<u>Disadvantages</u>
Construction methods are inexpensive and quick; suitable for emergency measures	Provide only temporary erosion control while slopes are stabilized with vegetative growth
No special materials or equipment are required	Entail extra cost for periodic inspections and maintenance and ultimate removal
Effective in preventing erosion on long, steep slopes	
Can be used to channel storm runoff to sediment traps, drainage basins, or stabilized waterways for offsite transport	If improperly designed, may overflow and cause severe erosion in concentrated areas

(Continued)

<u>Advantages</u>	<u>Disadvantages</u>
Can be key element in combined surface control systems	Downpipes are suitable for drainage areas 2 hectares (5 acres) in size limited applications in general

f. Levees and Floodwalls.

(1) Description and applications.

(a) Levees are earthen embankments that function as flood protection structures in areas subject to inundation from tidal flow or riverine flooding. Levees create a barrier to confine flooding waters to a floodway and to protect structures behind the barrier. They are most suitable for installation of flood fringe areas or areas subject to storm tide flooding, but not for areas directly within open floodways.

(b) Flood containment levees may be constructed as perimeter embankment surrounding disposal sites located in floodplain fringe areas, or they may be installed at the base of landfills along slope faces that are subject to periodic inundation.

(c) Levees are generally constructed of compacted impervious fill. Special drainage structures are often required to drain the area behind the embankment. Levees are normally constructed for long-term flood protection, but they require periodic inspection and maintenance to ensure proper functioning. They may be costly to build and maintain, but if properly designed on a site-specific basis, levees will reduce flooding hazards at critical waste disposal areas.

(2) Design and construction considerations.

(a) To provide adequate flood protection, levees should be constructed to a height capable of containing a design flood of 100-year magnitude. Elevation of 100-year base flood crests can be determined from floodplain analyses typically performed by state or local flood control agencies. A minimum levee elevation of 0.6 m (2 feet) above the 100-year flood level is recommended.

(b) Figure 3-28 presents design features of a typical levee constructed at the toe of a landfill slope. This design is appropriate for new or incomplete disposal sites; filled wastes may eventually be placed on the inboard slope of the levee.

(c) Ideal construction of levees is with erosion-resistant, low permeability soils, preferably clay. Most levees are homogeneous embankments; but if impermeable fill is lacking, or if seepage through and below the levee is a problem, then construction of a compacted impervious core or sheet-pile cutoff extending below the levee to bedrock (or other impervious stratum) may

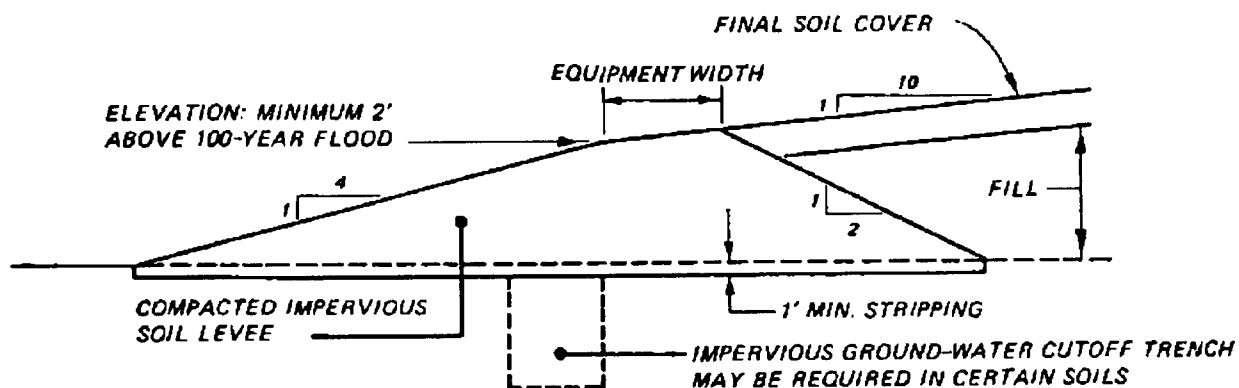

Figure 3-28. Typical Levee at Base of Disposal Site

be necessary. Excess seepage through the levees should be collected with gravel-filled trenches or tile drains along the interior of the levee. After draining to sumps, the seepage can be pumped out over the levee. Levee bank slopes, especially those constructed of less desirable soils (silts, sands), should be protected against erosion by sodding, planting of shrubs and trees, or use of stone riprap.

(d) Storm run-off from precipitation falling on the drainage area behind the levee may cause backwater flooding.

(e) Because of the relatively long, flat side slopes of levees, an embankment of any considerable height requires a very large base width. For locations with limited space and fill material, or excessive real estate costs, the use of concrete floodwalls is preferred as an alternative to levee construction.

(f) Floodwalls are designed to withstand the hydrostatic pressure exerted by water at the design flood level. They are subject to flood loading on one side only; consequently, they need to be well founded. Figure 3-29 presents typical floodwall sections. Like levees, floodwalls may require subsurface cutoffs and interior drainage structures to handle excessive seepage or backwater flow.

(3) Advantages and disadvantages. The advantages and disadvantages associated with flood protection levees at waste disposal sites are summarized below:

Advantages	Disadvantages
Can be built at relatively low cost from materials available at site	Flooding from storm runoff behind levee may be a problem

(Continued)

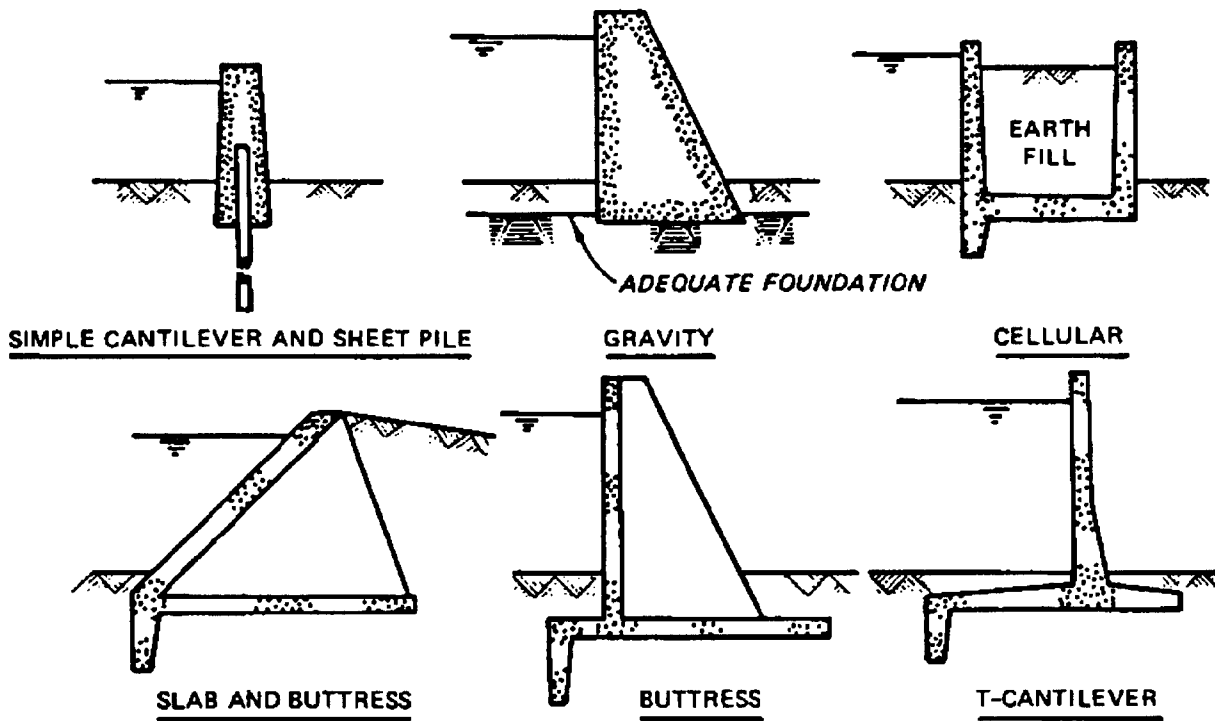

Figure 3-29. Some Typical Floodwall Sections

Advantages	Disadvantages
Will provide long-term flood protection if properly designed and constructed	Loss of flow storage capacity, with greater potential of downstream flooding
Control major erosive loss of waste and cover material; prevent massive leachate production and subsequent contamination from riverine or tidal flooding	Levee failure during major flood will require costly emergency measures (emergency embankments; sand bags) and rebuilding of structure
	Require periodic maintenance and inspections
	Special seepage cutoffs or interior drainage structures (e.g., pressure conduits) will add to construction costs

g. Seepage Basins and Ditches.

(1) General description and applications. Seepage or recharge basins are designed to intercept run-off and recharge the water downgradient from the site so that ground-water contamination and leachate problems are avoided or minimized.

(2) Design and construction considerations.

(a) There is considerable flexibility in the design of seepage basins and ditches. Figures 3-30 and 3-31 illustrate possible design variations. Where seepage basins are used (Figure 3-30), run-off will be intercepted by a series of diversions, or the like, and passed to the basins. As illustrated, the recharge basin should consist of the actual basin, a sediment trap, a bypass for excess run-off, and an emergency overflow. A considerable amount of recharge occurs through the sidewalls of the basin, and it is preferable that these be constructed of pervious material. Gabions are frequently used to make sidewalls. An alternative design for a seepage basin is shown in Figure 3-31; it is usually used where the aquifer is shallow.

(b) Seepage ditches (Figure 3-32) distribute water over a larger area than can be achieved with basins. They can be used for all soils where permeability exceeds about 2.94×10^{-5} cm/sec (0.9 inch per day). Run-off is disposed of by a system of drains set in ditches of gravel. Depth and spacing of drains depend on soil permeability. A minimum depth of 1.2 m (48 inches) is generally recommended, and ditches are rarely less than 3 m (10 feet) apart. The ditches are backfilled with gravel, on which the distribution line is laid. Sediment is removed prior to discharging run-off into the seepage ditches by use of a sediment trap and distribution box.

(3) Advantages and disadvantages. Advantages and disadvantages of drainage systems are listed below:

<u>Advantages</u>	<u>Disadvantages</u>
Cost-effective means of intercepting run-off and allowing it to recharge	Seepage basins and ditches are susceptible to clogging
Systems can perform reliably if well maintained	Deep basins or trenches can be hazardous
	Not effective in poorly permeable soils

h. Sedimentation Basins/Ponds.

(1) General description and application. Sediment basins are used to control suspended solids entrained in surface flows. A sedimentation basin is constructed by placing an earthen dam across a waterway or natural depression, or by excavation, or by a combination of both. The purpose of installing a sedimentation basin is to impede surface run-off carrying solids, thus

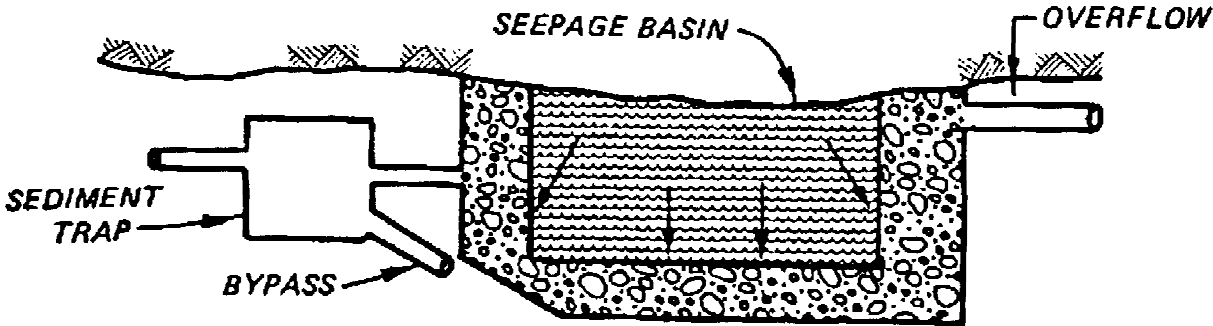

Figure 3-30. Seepage Basin; Large Volume, Deep Depth to Ground Water

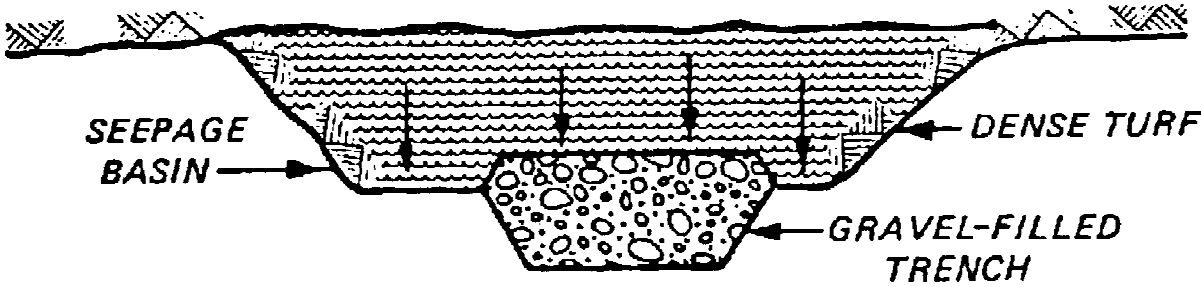

Figure 3-31. Seepage Basin: Shallow Depth to Ground Water

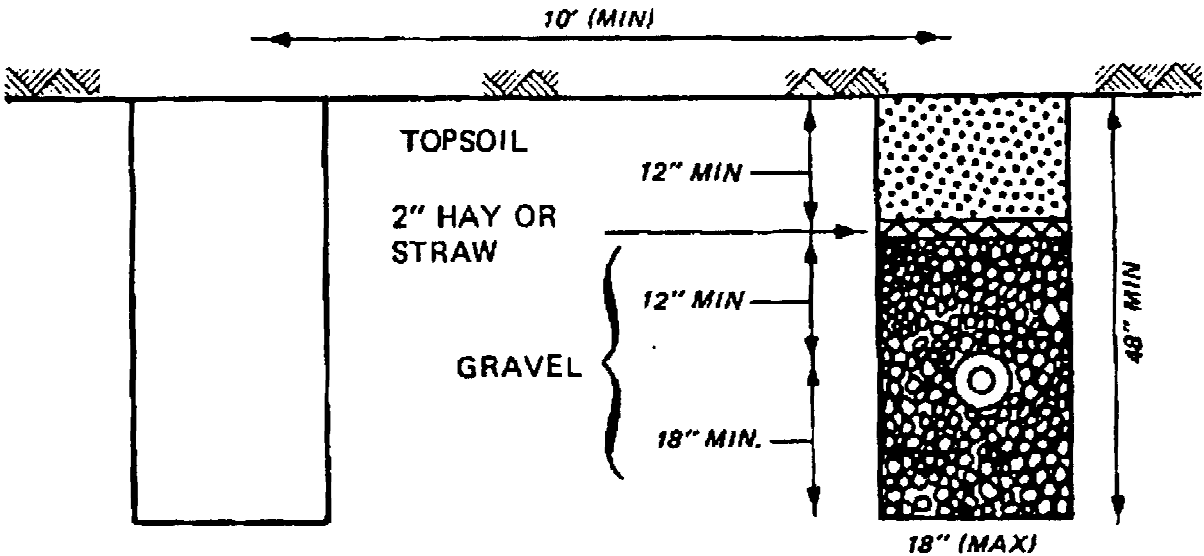

Figure 3-32. Seepage Ditch

allowing sufficient time for the particulate matter to settle. Sedimentation basins are usually the final step in control of diverted surface run-off, prior to discharge into a receiving water body. They are an essential part of any good surface flow control system and should be included in the design of remedial actions at waste disposal sites.

(2) Design and construction considerations.

(a) The removal of suspended solids from waterways is based on the concept of gravitational settling of the suspended material.

(b) The size of a sedimentation basin is determined from characteristics of flow such as the particle size distribution for suspended solids, the inflow concentration, and the volumetric flow rate. To calculate the area of the sedimentation basin pond required for effective removal of suspended solids, the following data on the flow characteristics are needed:

! The inflow concentration of suspended solids.

! The desired effluent concentration of suspended solids. The desired effluent concentration is usually regulated by local and/or Federal government authorities. For example, for coal mines, the proposed EPA "Effluent Guidelines and Standard" limits are as follows: total suspended solids concentration maximum for any one day shall not exceed 70 milligrams per liter, and average daily values for 30 consecutive days shall not exceed 35 milligrams per liter.

! The particle-size distribution for suspended solids.

! The water flow rate (Q) to the pond. For a pond receiving direct run-off, the run-off volume over a certain period of time must be determined. As an example, EPA has chosen the 10-year, 24-hour precipitation event as a design criteria for the overflow rate determination.

(c) A typical installation of a sedimentation basin embankment is illustrated in Figure 3-33. As shown, the pond consists of a dike which retains the polluted water flow. For water drawdown purposes, a principal spillway is also needed.

(d) Emergency spillways are also suggested in the design of a sediment basin. They are provided to convey large flows safely past an earth embankment, and they are usually open to channels excavated in earth, rock, or reinforced concrete.

(e) The efficiency of sedimentation ponds varies considerably as a function of the overflow rate. Sedimentation ponds perform poorly during periods of heavy rains and cannot be expected to remove the fine-grained suspended solids. If the sedimentation pond is expected to remove sediments that may have been contaminated by waste materials, consideration should be given to improving removal efficiencies by modifying basin or outlet design.

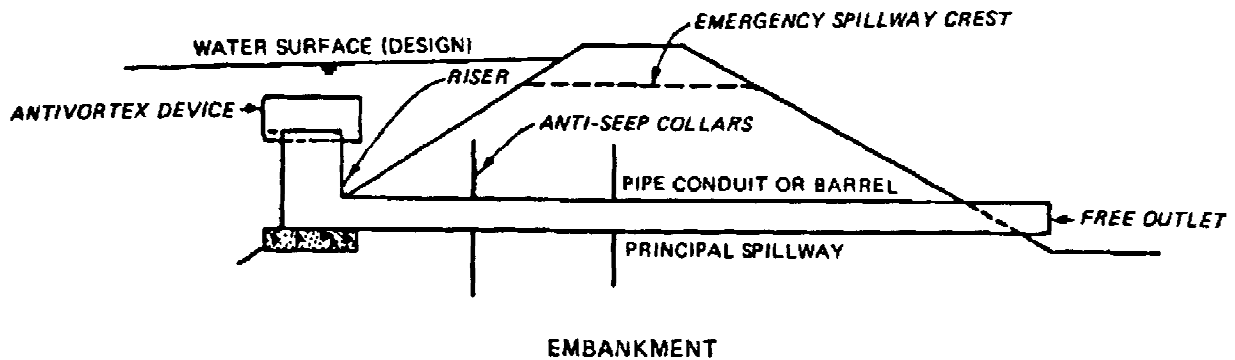

Figure 3-33. Typical Design of a Sediment Basin Embankment

(f) The quantity of material to be stored is also an important consideration in the construction of the sedimentation basin. The required storage capacity can be calculated by multiplying the total area disturbed by a constant sediment yield rate.

(3) Advantages and disadvantages. The advantages and disadvantages of the sedimentation basin in the control of water flow contaminated with suspended solids are listed below.

Advantages	Disadvantages
Easy to design and install, proven technology	Ineffective on dissolved solids
Require low operational and maintenance effort	Faulty design or structural failure may result in extensive damages
Remove suspended solids very effectively	

3-23. Surface Grading.

a. Background.

(1) Grading is the general term for techniques used to reshape the surface of covered landfills in order to manage surface water infiltration and run-off while controlling erosion. The spreading and compaction steps used in grading are techniques practiced routinely at sanitary landfills. The equipment and methods used in grading are essentially the same for all landfill surfaces, but applications of grading technology will vary by site. Grading is often performed in conjunction with surface sealing practices and revegetation as part of an integrated landfill closure plan.

(2) The major goals in surface grading of an uncontrolled waste site are to:

(a) Reduce ponding on the site and consequently minimize infiltration of water into any buried wastes.

(b) Reduce the rate of contaminant leaching from soils.

(c) Reduce erosion of cover soils that isolate any buried waste.

(3) Proper site grading is in almost all cases an advantage in the control of the potential contaminants. Since standing water in a waste site will leach contaminants from the surface materials, it is generally more likely to create a treatment problem than water collected running from the area. Ponding also creates aesthetic and trafficability problems.

(4) Finished grades at waste sites are designed on the basis of natural site topography, soil type, slope stability, rainfall intensity, size of the site, and type of final vegetative cover proposed.

b. Description and Applications.

(1) Grading techniques modify the natural topography and run-off characteristics of waste sites to control infiltration and erosion. The choice of specific grading techniques for a given waste disposal site will depend on the desired site-specific functions of a graded surface. A graded surface may reduce or enhance infiltration and detain or promote run-off. Erosion control may be considered a complicating variable in the design performance of a grading scheme.

(2) For disposal sites in wet climates (i.e., where precipitation annually exceeds evaporation and transpiration) and where subsurface hazardous leachate generation is a major problem, control of surface water infiltration is of primary importance. Manipulation of slope length and gradient is the most common grading technique used to reduce infiltration and promote surface water run-off. A slope of at least 5 percent is recommended as sufficient to promote run-off and decrease infiltration without risking excessive erosion.

(3) At landfill and dump sites where an effective surface sealing has been applied (e.g., clay cap or synthetic membrane and a topsoil layer), various grading techniques can be used to prepare the covered surface for revegetation. The grading methods- -scarification, tracking, and contour furrowing- -create a roughened and loosened soil surface that detains run-off and maximizes infiltration. Such techniques are especially important for establishing vegetation in arid regions.

c. Design and Construction Considerations.

(1) The design of graded slopes at waste disposal sites should balance infiltration and run-off control against possible decreases in slope stability and increases in erosion. The design of specific slope configurations, the choice of cover soil type, the degree of compaction, and the types of grading equipment used will all depend on local topography, climate, and future land use of the site.

(2) Improperly graded slopes may deform or fail, opening cracks, exposing waste cells, and allowing lateral seepage of leachate. Soils used to cover graded slopes should be selected on the basis of shear strength and erodibility. Soils high in silt and fine sand and low in clay and organic matter are generally most erodible. Also, the longer and steeper the slope is, and the sparser the vegetation cover, the more susceptible it is to erosive forces.

(3) In grading a landfill surface before construction of a seal, two important considerations apply. First, bulky and heavy waste objects should not be filled near the surface of the site because they may settle unevenly and deform or crack graded cover. Also, to provide a firm subgrade and prevent seal failure, existing cover material should be compacted to a Proctor density of 70 to 90 percent of maximum.

(4) The equipment types used to construct graded slopes consist of both standard and specialized landfill vehicles. Excavation, hauling, spreading, and compaction of cover materials are the major elements of a complete grading operation.

(5) Specialized landfill vehicles include compactors and scrapers. Steel-wheeled landfill compactors are excellent machines for spreading and compacting on flat to moderate slopes. Scrapers are effective in excavating, hauling, and spreading cover materials over relatively long distances.

d. Advantages and Disadvantages.

(1) Surface grading of covered disposal sites, when properly designed and constructed to suit individual sites, can be an economical method of controlling infiltration, diverting run-off, and minimizing erosion. A properly sealed and graded surface will aid in the reduction of subsurface leachate formation by minimizing infiltration and promoting erosion-free drainage of surface run-off. Grading can also be used to prepare a cover soil capable of supporting beneficial plant species.

(2) There may be certain disadvantages associated with grading the surface of a given site. Large quantities of a difficult-to-obtain cover soil may be required to modify existing slopes. Suitable sources of cover material may be located at great distances from the disposal site, increasing hauling costs. Also, periodic regrading and future site maintenance may be necessary to eliminate depressions formed through differential settlement and compaction, or to repair slopes that have slumped or become badly eroded.

3-24. Surface Sealing.

a. Background.

(1) Landfill covers or caps prevent water from entering a landfill, thus reducing leachate generation, and also control vapor or gas produced in the water. Landfill covers can be constructed from native soils, clays, synthetic membranes, soil cement, bituminous concrete, or asphalt/tar materials. In most cases, the cap is constructed using the same equipment

used in construction and grading. The cap should be designed to have sufficient thickness to accommodate the anticipated settlements, deformations, desiccation cracking, and constructibility. Where native soil is used for the cap, soil additives or specialized construction techniques may be necessary to obtain the required plasticity and permeability. A permeability of 10^{-7} to 10^{-8} cm/sec is considered appropriate.

(2) A cover is a useful option at sites where the major pathway for contaminant transport is percolation of infiltrating precipitation or in cases where control of gases or volatile compounds in the waste is a serious consideration. When a cap is designed for toxic or flammable gas control, gas venting and disposal systems should be considered an integral part of the capping system.

(3) Capping systems are an advantage at any site where incoming precipitation can be minimized and leach rates reduced. In areas where the wastes are buried below the water table and lateral flow of ground water is evident, capping may not be completely effective in reducing contaminant transport. In a capped landfill at Windham, CT, that was partly below the water table, a definite decrease in the degree of contamination in ground water downgradient from the site was noted. Capping is usually an economical system, and because the top of the landfill is accessible, the cap can be maintained and repaired.

b. Description and Applications.

(1) Clays and soils.

(a) Cover soils are spread over waste layers at most operating landfills on a daily or intermediate basis prescribed by state and local standards in order to control vectors, odors, and windblown rubbish. These soils are generally supplied from onsite excavated fill and are not selected for special qualities. Soil used for final cover on completed fills or for capping uncontrolled waste sites, however, must be relatively impermeable (low permeability coefficient, k) and erosion-resistant. Fine-grained soils such as clays and silty clays have low k values and are therefore best suited for capping purposes because they resist infiltration and percolation of water. These fine-grained soils, however, tend to be easily eroded by wind, especially in arid climates where coarse, heavy-grained gravels and sands provide more suitable cover.

(b) Blending of different soil types broadens the grain-size distribution of a soil cover and minimizes its infiltration capacity. Well-graded soils are less permeable than those with a small range of grain sizes, and mixing of local coarse and fine-grained soils is a cost-effective method of creating stronger and less porous cover soil. For example, when fine soils are not available locally, the addition of gravel or sand to fine-grained silts and clays enhances strength and reduces percolation.

(c) Similarly, additions of clay to sandy or silty cover material will lead to dramatic reductions in the k value of the soil. Blending can often be

accomplished in place using a blade or harrow to turn and mix the soil to suitable depths.

(d) The Atterberg limits are a good first approximation of the mechanical behavior of a clay-type soil. The limits are defined by the water content of the soil that produces a specified consistency. In themselves the Atterberg limits mean little; however, when used as indexes to the relative properties of a clay-type soil they are very helpful.

(e) The most important soil property that will affect the performance of a cover is its permeability. Mechanical compaction is used to alter the soil properties and develop a permeability suitable for the cover being constructed. Design parameters for compaction are based on a unique density value (maximum density) and a corresponding moisture content (optimum moisture content). Generally it can be assumed that the more granular the soil (the more sandy it is), the higher the maximum density and the lower the optimum moisture content. Also the finer the soil (the more clayey it is), the less defined the maximum density is as a function of the moisture content. Typically soils used for covers will have a clay content in excess of 25-30 percent which will have a poorly defined maximum density.

(f) Density quality control in the field is very important and requires a great deal of attention and skill. When compacting a cover material on the relatively soft base of the refuse, problems in obtaining the proper compaction can result. Also, the possibility of penetrating a cap with large pieces of refuse upon compaction should be considered. For these reasons a strict field testing and quality control program should be followed during construction.

(g) When constructing the final landfill cap, normal construction techniques will apply. It is very important that the buffer layer between the refuse and barrier be thick and dense enough to provide a stable base and prevent large pieces of refuse from penetrating the barrier. The barrier layer should be covered immediately after compaction is complete to prevent drying and crack formation. The final top soil layer should not be compacted and should be seeded and mulched as soon as possible to prevent erosion.

(2) Asphalt and admixed materials.

(a) There is a variety of admixed materials that can be formed in-place to fabricate a liner and cover. These materials include asphalt, concrete, soil cement, soil asphalt, catalytically blown asphalt, asphalt emulsions, lime, and other chemical stabilizers. Many of these materials can be sprayed directly on prepared surfaces in a liquid form. This material then solidifies to form a continuous membrane.

! Hydraulic asphalt concrete is a hot mixture of asphalt cement and mineral aggregate. It is resistant to the growth of plants and weather extremes and will resist slip and creep when applied to side slopes. The material should be compacted to less than 4 percent voids to obtain the low permeability needed.

! Soil cement is a compacted mixture of portland cement, water, and selected in-place soils. The soil used should be nonorganic and well graded with less than 50 percent silt and clay. The soil should also have a maximum size of 0.75 inch and a maximum clay content of 35 percent. Soil cement has the disadvantage of cracking and shrinking upon drying.

! Soil asphalt is similar to soil cement; however, the soil used should be a low plasticity, gravelly soil with 10-25 percent silty fines. The membrane must be waterproofed with a hydrocarbon or bituminous seal.

! Catalytically blown asphalt is manufactured from asphalts with high softening points by blowing air through the molten asphalt in the presence of a catalyst such as phosphorus pentoxide or ferric chloride. The material can then be sprayed on a prepared surface regardless of cold or wet weather. As with soil asphalt the membrane must be waterproofed with a hydrocarbon or bituminous seal.

! Asphalt emulsions can also be sprayed directly on prepared surfaces at temperatures above freezing. These membranes are less tough and have lower softening points than hot air-blown asphalt. However, the toughness and dimensional stability can be increased by spraying onto supporting fabrics.

(b) A summary of spray-on chemical stabilizers for cover soils is shown in Table 3-7.

(c) Sprayed-on liners and covers require a more carefully prepared subgrade than other liner and cover membranes. If a smooth surface cannot be obtained with the subgrade, a fine sand or soil padding may be necessary. Even with a properly prepared subgrade, care must be taken in placing the material to make it pinhole free.

(d) Cover soils treated with lime, which contributes pozzolanic (cementing) properties to the resulting mixture, optimize the grain-size distribution and reduce shrink/swell behavior. Lime applied as 2 to 8 percent (by weight) calcium oxide or hydroxide is suitable for cementing clayey soils. Rotary tiller mixing followed by water addition and compaction is the general application sequence for these mixtures. Also, additions of lime are recommended for neutralizing acidic cover soils, thereby reducing the leaching potential of heavy metals. If a synthetic liner is present, liner life can be prolonged by lime addition to supporting soil.

(e) Other cover soil-chemical additives may include chemical dispersant and swell reducers. Soluble salts such as sodium chloride, tetrasodium pyrophosphate, and sodium polyphosphate are added primarily to fine-grained soils with clay minerals to deflocculate the soils, increase their density, reduce permeability, and facilitate compaction. Additives are more effective with montmorillonite clay than with kaolinite or illite. Because soils in the northeast and midwest continental United States are usually low in montmorillonite, site-specific testing should be undertaken before using additives with soils in these areas.

(3) Synthetic membranes.

Table 3-7. Summary of Chemical Stabilizers for Cover Soil

Name	Soil stabilizer	Mulch	Mulch tack	Erosion resistance		Description	Product information
				Water	Dust/wind		
Aerospray® 52	x	x		x		Water dispersible, alkyl resin emulsion; forms hard crust; nontoxic; nonphytotoxic, pH 8-9; \$0.75/l (~\$2.85/gal)	American Cyanamid Co., Industrial Chemicals and Plastic Div. Wayne, NJ 07970
Aerospray® 70	x	x	x	x		Water dispersible polyvinyl acetate resin emulsion; effective in sand; \$0.66/l (~\$2.50/gal)	American Cyanamid Co., Industrial Chemicals and Plastic Div. Wayne, NJ 07970
Aquatain	x	x		x		Water dispersible, concentrate of chemicals and pectin; forms fragile crust; nontoxic; nonflammable; \$0.61/l (~\$2.30/gal)	Larutan Corp., Anaheim, CA 02805
Curasol® AE	x	x	x	x		Water dispersible, polyvinyl acetate latex emulsion; hard crust; nontoxic; nonphytotoxic; pH 4-5; \$0.69/l (~\$2.60/gal)	American Hoechst Corp., Bridgewater, NJ 08876

(Continued)

Table 3-7. (Concluded)

Name	Soil stabilizer	Mulch tack	Mulch tack	Erosion resistance		Description	Product information
				Water	Dust/wind		
Curasol® AH	x	x	x	x		Water dispersible; high polymer synthetic resin; flexible crust; non-toxic; nonphytotoxic; pH 4-5	American Hoechst Corp., Bridgewater, NJ 08876
DCA - 70	x	x	x	x		Water dispersible; polyvinyl acetate emulsion; can be reinforced with fiberglass filaments; nontoxic; nonphytotoxic; nonflammable; pH 4-6	Union Carbide Corp., Chemicals and Plastics New York, NY 10017
Petroset®	x	x	x	x		Water dispersible oil emulsion; effective in particles below gravel size; nontoxic; nonflammable; pH 6 ± 0.5; \$0.42/t (\$1.60/gal)	Phillips Petroleum Co., Chemical Dept., Bartlesville, OK 74003

(Sources: Lutton et al. 1979 and EPA 1976).

(a) The use of synthetic membrane in surface water control is new, and a wide variety of synthetic materials and compounds are being manufactured, tested, and marketed. The various membranes being produced vary not only in physical and chemical properties but also in installation procedures, costs, and chemical compatibility with waste fluids. Not only are there variations in the polymers being used but also with the compounding agents such as carbon black, pigments, plasticizers, crosslinking chemicals, antidegradants, and biocides. The sheeting is then joined or seamed together into panels as large as 30 m (100 feet) by 61 m (200 feet) depending on weight and handling limitations. The various seaming techniques include: heat seaming, dielectric seaming, adhesive seaming, and solvent welding. The four types of polymers generally considered for use in membranes are vulcanized rubbers, unvulcanized plastics such as PVC, highly crystalline plastics, and thermoplastic elastomers. The thicknesses of the polymeric membranes used in landfill applications range from 0.5 to 3 mm (20 to 120 mil), with most in the 0.5 to 1.5 mm (20- to 60-mil) range. Most membrane liners and covers are manufactured from unvulcanized polymeric (thermoplastic) compounds. The thermoplasticity allows the material to be heated for fusing or seaming without losing its original properties when cooled.

(b) One of the most important components in the installation of a synthetic membrane is the preparation of the subgrade. The subgrade must provide even support for the membrane, or the unsupported membrane could very easily fail. The in-situ soil that will be used for the subgrade should be tested for its physical, mechanical, and chemical character. These tests should determine, among other things, the shrink/swell properties of the soil and the density, strength, settlement, and permeability of the subgrade's soil. Soils with high shrink/swell characteristics will tend to weaken earthen structures or cause void spaces which will cause membrane failure. Organic matter in the subgrade can cause membrane failure by leaving void spaces or by generating gases during the decaying process which collect under the membrane and cause a ballooning effect. Surface diversion ditches should be used to prevent the erosion of cover material on a membrane cap. Temperature extremes can make membrane placement difficult. Low temperatures can make a membrane brittle while high temperatures can cause a membrane to stretch easily.

(c) Anchoring a membrane can be accomplished in two ways. The liner can be anchored to a concrete structure, or a more economical and simpler method is the trench-and-backfill method. In this method the membrane is temporarily secured in the anchor trench while the seaming takes place, and then the trench is backfilled.

(d) Field seaming is the most critical factor in membrane installation. The membrane manufacturers have recommended sealing procedures and adhesives. If there are no recommended bonding systems, then the use of that specific material should be questioned. As with the membrane material, the integrity of the seam depends on the compatibility of the finished seam with the waste fluids with which it comes in contact. As a general rule, field seams should run vertically on side slopes where possible without decreasing panel size or increasing field seaming. Field seaming should not

be done during precipitation, and the number of panels placed in one day should not exceed the number of panels seamed that day.

(4) Waste materials. Another class of available cover materials includes waste materials such as nonhazardous industrial residues, dredged sediments, and wood chips. Fly ash and lime/fly ash mixtures have also been considered for cover materials; however, the hazardous contaminants in most fly ash have discouraged its use. Furnace slag and incinerator residue are two additional waste materials of gravelly and sandy size that may be suitable for blending into soil cover for slope erosion protection. Rocky overburden from mines, quarries, and sand and gravel pits may also be locally useful as soil cover substitutes. Heavy applications of durable crushed stone, gravel, or clinkers (overcooked bricks) may be used to stabilize contaminated surface soils at landfills and dumps. Nontoxic industrial sludges such as paper mill sludge, dredged materials such as reservoir and channel silt, and composted sewage sludge are other waste materials that may be applied as substitutes or supplements to conventional cover material. Dried sludge can also provide nitrogen and organic plant nutrients in a final capping situation which will aid in establishing a vegetative cover.

c. Design and Construction Considerations.

(1) The design and implementation of a cost-effective capping strategy involves first the selection of an appropriate cover material. Site-specific cover functions--control of water infiltration and gas migration, water and wind erosion control, crack resistance, settlement control and waste containment, side slope stability, support of vegetation, and suitability for further site use--may be ranked in order of importance to facilitate this selection. For soils that may potentially be used in capping, laboratory and field testing of physical and chemical properties may be necessary when the choice is not clear-cut. Void ratio, porosity, water content, liquid and plastic limits, shrinkage limit, pH and nutrient levels, shear resistance, compaction, permeability, shrink/swell behavior, and grain size are some of the properties that may have to be determined for competing soil types.

(2) Where soil erosion control is a major consideration, the USDA Universal Soil Loss Equation (USLE) may be useful for comparing the predicted effectiveness of different cover soils.

(3) For information regarding soil sampling and testing, for local data on soils and climate, or for any form of technical assistance regarding selection of cover materials, regional and county Soil Conservation Service (SCS) offices should be consulted.

(4) Placement and compaction of cover materials are techniques affected by site-specific considerations such as the type of cover materials being applied and the local availability of equipment and manpower. For cover soils, compaction is generally desirable in order to increase the strength and reduce the permeability of the cap. Compactor vehicles include rubber-tired loaders and various rollers. For compaction of most solid waste covers, the conventional track-type tractor is effective. The number of passes over the surface required to achieve sufficient compaction depends on the equipment

type (size, weight, and width of compactor), the water content of the soil cover, and the base density and resilience of the covered refuse.

(5) Layering is an effective, but underutilized technique for final cover at waste disposal sites. This technique is essentially a cover system that combines several layers of different materials that serve integrated functions—support of vegetation protection of barrier layers of membranes control of water infiltration and gas exfiltration, filtering, etc., depict examples of two-layered covered systems. A typical layered cover system may be composed of the following layers:

(a) Topsoil - usually loose, uncompacted surface layer of loams for vegetative support; may be treated with fertilizers or conditioners.

(b) Barrier layer or membrane - usually clayey soil with low k value, or a synthetic membrane; restricts passage of water or gas.

(c) Buffer layer - above and/or below barrier layer; protects clays from drying or cracking, synthetic membranes from punctures or tears; provides smooth, stable base; often a sandy soil.

(d) Water/gas drainage layer or channel - poorly graded (homogeneous) sand and gravel; channels subsurface water drainage; intercepts and laterally vents gases.

(e) Filter - intermediate grain-size layer to prevent fine particles from penetrating the coarser layer; controls settlement, stabilizes cover.

(6) A membrane and geotextile system may be used as the barrier and drainage layers under appropriate conditions. In this system a geotextile (nonwoven filter fabric) is used under a synthetic membrane to provide venting and a suitable base for membrane placement.

d. Advantages and Disadvantages.

(1) An evaluation of selected cover materials and cover systems must be made on a site-specific basis. However, certain general advantages and disadvantages of different surface-sealing techniques can be mentioned here.

(2) Fine-grained soils composed predominantly of clay are well suited for final cover in humid climates because of their low permeability. However, such soils tend to shrink and crack during dry seasons. The construction of a two-layer cover system may be useful in solving such problems.

(3) Local soils generally are much less expensive than non-native cover materials that have to be transported to the site. Where local soils are poorly graded (homogeneous grain size), blending is an effective technique for creating more suitable cover soils.

(4) Soil additives and cements have relatively high unit costs and may require special mixing and spreading methods. Also, soils modified by additions of cement, bitumen, or lime become rigid and more susceptible to

cracking due to waste settlement or freeze-thaw stresses. Patching repairs may become necessary to seal cracks that allow for escape of volatiles and allow surface water infiltration. Also, cemented soil systems may deteriorate upon extended exposure to corrosive organic and sulfurous waste products in landfill environments.

(5) Rigid barriers such as concrete and bituminous membranes are also vulnerable to cracking and chemical deterioration, but the cracks can be exposed, cleaned, and repaired (sealed with tar) with relative ease. Concrete covers may have a design life of about 50 years, except when applied to chemically severe or physically unstable landfill environments.

(6) Synthetic membranes are vulnerable to tearing, sunlight, exposure, burrowing animals, and plant roots. They also require special placement and covering procedures. Among the commercially available synthetic liners, polyethylene may be the most economical, based on both performance and cost. Locally generated waste materials such as fly ash, furnace slag, and incinerator residue may be inexpensive (or free) and, therefore, useful as cost-effective cover materials or additives. However, such materials may leach soluble trace pollutants (e.g., sulfur, heavy metals) and may actually contribute to environmental contamination.

3-25. Revegetation. The establishment of a vegetative cover may be a cost-effective method to stabilize the surface of hazardous waste disposal sites, especially when preceded by surface sealing and grading. Vegetation reduces raindrop impact, reduces run-off velocity, and strengthens the soil mass with root and leaf fibers, thereby decreasing erosion by wind and water. Revegetation will also contribute to the development of a naturally fertile and stable surface environment. Although the soil's infiltration capacity is increased by vegetation allowing considerable water to enter the disposal site, this increased infiltration is offset at least partly by vegetative transpiration. The relative importance of these offsetting processes is a complicated question that has not been conclusively answered (Lutton et al. 1979). Revegetation can also be used to upgrade the appearance of disposal sites that are being considered for re-use options. Short-term vegetative stabilization (i.e., on a semiannual or seasonal basis) can also be used as a remedial technique for uncontrolled disposal sites.

a. Applications and Design Considerations.

(1) Revegetation may be part of a long-term site reclamation project, or it may be used on a temporary or seasonal basis to stabilize intermediate cover surfaces at waste disposal sites. Revegetation may not be feasible at disposal sites with high cover soil concentrations of phytotoxic chemicals, unless these sites are properly sealed and vented and then recovered with suitable topsoil. A systematic revegetation plan will include: (a) selection of suitable plant species, (b) seedbed preparation, (c) seeding/planting, (d) mulching and/or chemical stabilization, and (e) fertilization and maintenance.

(2) Long-term vegetative stabilization generally involves the planting of grasses, legumes, and shrubs. The establishment of short-term, seasonal

vegetative cover is limited principally to species of grasses. The selection of suitable plant species for a given disposal site depends on several site-specific variables.

(3) Grasses such as fescue and lovegrass provide a quick and lasting ground cover, with dense root systems that anchor soil and enhance infiltration. Legumes (lespedeza, vetch, clover, etc.) store nitrogen in their roots, enhancing soil fertility and assisting the growth of grasses. They are also readily established on steep slopes. Shrubs such as bristly locust and autumn olive also provide a dense surface cover, and certain species are quite tolerant of acidic soils and other possible disposal site stresses. Trees are generally planted in the later stages of site reclamation, after grasses and legumes have established a stable ground cover. They help provide long-term protective cover and build up a stable, fertile layer of decaying leaves and branches. A well-mixed cover of grasses, shrubs, and trees will ultimately restore both economic and aesthetic value to a reclaimed site, providing suitable habitat for populations of both humans and wildlife.

(4) Seedbed preparation is necessary to ensure rapid germination and growth of the planted species. Applications of lime will help neutralize highly acidic topsoils. Similarly, fertilizers should be added for cover soils low in essential plant nutrients. Optimum soil application rates for lime and fertilizers should be determined from site-specific soil tests. Where required, lime should be worked to 152 mm (6-inch) depths into the soil by discing or harrowing. For dense, impervious topsoils, loosening by tillage is recommended.

(5) Seeding should be performed as soon as possible after final grading and seedbed preparation. The most common and efficient method of seeding large areas of graded slopes is with hydroseeders. Seed, fertilizer, mulch, and lime can be sprayed from hydroseeders onto steep outslopes and other areas of difficult access. Rear-mounted blowers can be attached to lime trucks to spread seed and fertilizers over such areas. Grass or grain drills may be used to apply seed on gently rolling or level, stone-free terrain. Hand planting, a time-consuming and costly project, may be required for trees and shrubs.

(6) Mulches or chemical stabilizers may be applied to seeded soils to aid in the establishment of vegetative cover and to protect it from erosion before the plants become established. Organic mulches such as straw, hay, wood chips, sawdust, dry bark, bagasse (unprocessed sugar cane fibers), excelsior (fine wood shavings), and manure protect bare seedbed slopes from erosion prior to germination. Also, thin blankets of burlap, fiberglass, and excelsior can be stapled down or applied with asphalt tacks to form protective mulch mats for germinating seedbeds.

(a) Mulches conserve soil moisture, dissipate raindrop energy, moderate soil temperatures, prevent crusting, increase infiltration, and generally control wind and water erosion. Mulches are usually applied after seeding and fertilization, although certain mulch materials (e.g., wood fibers) may be applied as hydroseeder slurries mixed with seed, fertilizer,

and lime. Mulch application rates will vary depending on local climate, soil characteristics, and slope steepness.

(b) Loose straw and hay mulches are the most common and most cost-effective temporary soil stabilizer/mulching materials available. These mulches are best applied using a mulch blower, at rates from 1120 to 8960 kg/hectare (0.5 to 4 tons) per acre. Straw/hay mulches can be anchored to the soil by asphalt, chemical binders, or jute netting.

(c) Chemical stabilizers are binders and tacks that are sprayed on bare soils or mulches to coat, penetrate, and bind together the particles. Stabilizers reduce soil water loss and enhance plant growth by temporarily stabilizing seeded soils against wind and water erosion. They can also be used to stabilize graded soils in the off-season until spring seeding. Stabilizers are used extensively in arid regions to help dry, permeable soils retain soil moisture.

(7) Chemical soil stabilizers include latex emulsions, plastic firms, oil-in-water emulsions, and resin-in-water emulsions. Table 3-7 summarizes pertinent characteristics of seven commercially available stabilizers, including cost data (where available).

(8) In field tests comparing the effectiveness of these chemical additives in controlling erodibility of several regional soil types in Virginia, none of the stabilizers tested were determined to be as cost-effective as conventional mulches of straw and asphalt-emulsions.

(9) Periodic reliming and fertilization may be necessary to maintain optimum yearly growth on seeded plots. Soils with poor buffering capacity may require frequent liming to achieve suitable pH levels; these are generally soils high in organic matter or clay content. Annual fertilization of nitrogen-, phosphorus-, or potassium-deficient soils will also aid reclamation efforts. Fertilizer application rates will vary with the nutrient content and pH level of the seeded cover soil. Twice yearly mowing and the judicious use of selective herbicides will help control undesirable weed and brush species. Grass sodding and remulching or planting new shrubs and trees are recommended for sparsely covered, erosion-prone areas.

(10) The selection of suitable plant species for purposes of revegetating a given disposal site will depend on cover soil characteristics (grain size, organic content, nutrient and pH levels, and water content), local climate, and site hydrology (slope steepness and drainage characteristics). Individual species must be chosen on the basis of their tolerance to such site-specific stresses as soil acidity and erodibility and elevated levels of landfill gases or phytotoxic waste components (e.g. , heavy metals, salts) in cover soil. Other important considerations include the species compatibility with other plants selected to be grown on the site, resistance to insect damage and diseases, and suitability for future land use.

(11) The optimum time for seeding depends on local climatic considerations and the individual species adaptations. For most perennial species in most localities, early fall seeding is recommended. Annuals are

usually best seeded in spring and early summer, although they can be planted for quick vegetation whenever soil is damp and warm. In mild climates (e.g., southeastern United States) the growth of both summer and winter grasses will extend the range of evapotranspiration and erosion resistance for cover soils.

b. Advantages and Disadvantages. A well-designed and properly implemented revegetation plan--whether for long-term reclamation or short-term remedial action--will effectively stabilize the surface of a covered disposal site, reducing erosion by wind and water, and will prepare the site for possible reuse. Evapotranspiration and interception of precipitation by vegetative cover will also control leachate generation at landfills by drying out the water near surface layers of refuse and soil. This effect, however, is more or less offset by enhanced soil infiltration capacity due to the increased detention of surface flow by the vegetation and to effects of the root systems on the cover soil (increased permeability). If subsurface liners of clay or synthetic membranes are constructed, infiltration of water into buried wastes (and subsequent leachate production) will be greatly reduced. This illustrates the importance of a layered surface sealing system and properly graded slopes, which, in combination with suitable vegetative cover, will isolate buried wastes from surface hydrologic input.

Section VI. Gas Control

3-26. Gas Generation and Migration. Uncontrolled hazardous waste sites are unusual in that they can contain a wide variety of materials that can generate toxic or explosive gases (H_2S , H_2 , CH_4 , HCN) and many organic compounds with low vapor pressure that volatilize, forming toxic, flammable, or explosive vapors. Gas generation and migration from disposal operations can be grouped with two categories: methane generation and toxic vapor generation.

a. Gas Generation.

(1) Methane.

(a) The decomposition of any organic material in an anaerobic environment results in part in the production of methane gas. Typically, municipal solid waste (MSW) is largely degradable organic materials (50 to 80 percent). Since MSW is quite porous when placed and compacted in a landfill environment, large amounts of air (with 20 percent oxygen) are present. The result of the initial aerobic decomposition phase is the development of an anaerobic environment with a wide variety of cellulose- -glucose and organic acid breakdown products. This phase of refuse decomposition will last from a few months to a year. The methane-forming bacteria or methogens then use the organic acids as substrate to produce methane and carbon dioxide. The transition in landfill gas composition is illustrated in Figure 3-34.

(b) The methogens are slow-growing organisms and are very sensitive to environmental conditions. The aerobic decomposition phase produces a great deal of heat which will usually bring the internal temperature of a landfill within the optimum temperature range for methane production (29° to $37^\circ C$). The optimum moisture content for gas production in MSW is greater than

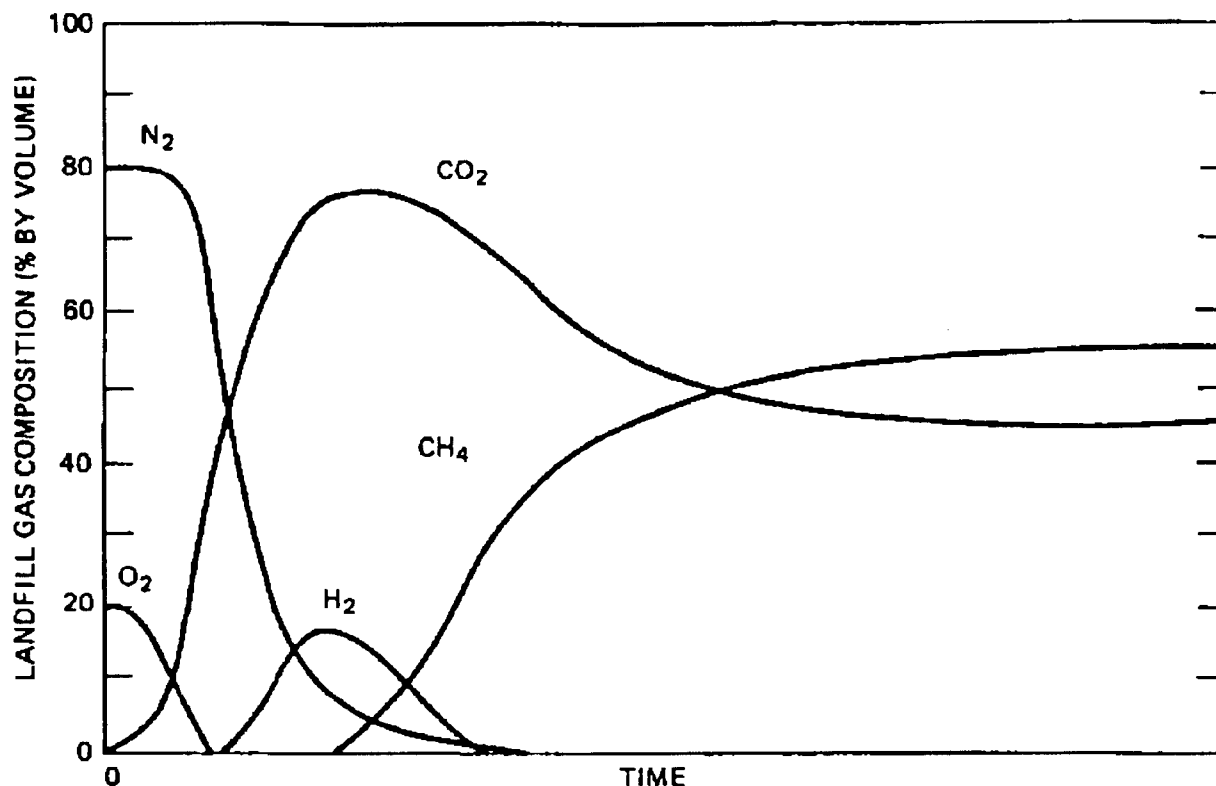

Figure 3-34. Landfill Gas Composition Transition

60 percent (on a weight basis). If the landfill is not in an arid environment, the refuse will usually become wet and the internal environment of the landfill will meet the conditions required for methane-forming bacteria.

(c) Landfills over two years old will usually contain methane in substantial concentrations in the interstitial gases. The time required for methane generation to begin in substantial quantities in a typical landfill is site specific and generally unpredictable. Environmental conditions such as temperature and precipitation and the composition of the refuse, especially the initial moisture content and density, as placed, are very important in determining when methane generation will begin. Also the mode of construction at the landfill and the type of final cover can significantly affect the time for an anaerobic environment to develop in the landfill and support methanogenic activity. The volume of gases produced in any particular landfill is very difficult to predict.

(d) On a wet-weight basis, the theoretical cubic feet of gas generated per pound of solid wastes was determined to be 6.5 for CO₂ and CH₄, and 3.3 for CH₄ alone. Studies assuming constant gas loss rates have estimated the duration of the methane-forming stage in landfill decomposition to be as short as 17 years. Other studies based the methane-generating capability on the rate at which carbon leaves the landfill, assuming that the initial amount of

carbon in the refuse was "available." These studies estimated that it would take 57 years for 50 percent of the carbon to leave the landfill and 950 years for 90 percent to leave. With the uncertainties involved one should assume the active biological decomposition in a landfill to continue indefinitely.

(2) Toxic vapor.

(a) Organic compounds in hazardous industrial waste will volatilize under favorable conditions to produce toxic vapors. Waste volatilization can occur at landfills, surface impoundments, and land treatment sites. Since the volatilization and degradation processes are very slow, the emission of hazardous volatile organic compounds may persist for many years. Gas generation rates at landfills containing industrial wastes have not been studied because of the complexity and characteristic variation to be found in the wastes. While the waste composition is the most important factor affecting the rate of gas generation, other factors affecting gas generation are the surrounding climate and soil.

(b) The principal mechanisms of toxic vapor generation at disposal sites are waste volatilization, biological degradation, and chemical reaction. The toxic property of the waste will inhibit biological activities, and most toxic organic wastes such as chlorinated hydrocarbon are relatively inert. Therefore, the amount of toxic vapor production in hazardous waste landfills resulting from biological and chemical processes appears relatively small compared with volatilization. For this reason estimates of toxic vapor generation are usually based on waste volatilization or vapor loss of organic compounds and treated as a diffusion controlled process.

b. Gas Migration.

(1) Landfill-generated methane and toxic-vapor migration are the result of two processes, convection and diffusion. Convection is the movement of landfill gas and toxic vapors in response to pressure gradients developed in the landfill, while diffusion is the movement of gas and vapors from high to lower concentrations. The normal landfill construction practice of alternating layers of refuse with 152 mm (6-inch) soil layers and finishing the landfill with a compacted clay cap of 305 mm (1 foot) or more can present substantial barriers to vertical migration and can increase lateral gas migration. Gas and vapor migration is also restricted by the relative insolubility of the gas in water. The presence of a high or perched water table, which is relatively common under landfill sites, can inhibit the depth of gas migration and increase lateral gas movement.

(2) Natural and man-made corridors for gas and vapor migration are quite common around landfill sites. Most landfill explosions are fueled by these corridors. Sewers, drainage culverts, and buried utility lines running near landfills can all provide corridors for gas and vapor migration. In addition, breaks in subsurface utility structures such as manholes, vaults, catch basins, or drainage culverts near landfills not only provide corridors for gas and vapor migration but also provide areas for potentially dangerous concentrations of gas to accumulate. Natural corridors for gas migration

include gravel and sand lenses and void spaces, cracks, and fissures resulting from landfill differential settlement.

3-27. Passive Gas Control Systems. Passive control systems include gravel-filled trenches, perimeter rubble vent stacks, and/or combinations of these. Passive systems will usually incorporate impermeable barriers. Passive venting systems should be deeper than the landfill to make sure they intercept all lateral gas flow. If possible the system should be tied into an impermeable zone such as the permanent water table or continuous impermeable geologic units. The systems should be backfilled with crushed rock, gravel, sand, or similar material that is graded to prevent infiltration and clogging by adjacent soil carried in by water. Passive systems without an impermeable liner can control convective gas flow; however, they are less effective in controlling diffusive gas flow.

a. Application.

(1) Vent stacks. These can be employed to control lateral and vertical migration for both methane and volatile toxics. The basic configurations in Figure 3-35 cover, or can be modified to cover, most of these applications. Atmospheric vents, both mushroom and "U" type, are used for venting methane at points where gas is collecting and building up pressure. Control of lateral migration of methane by an array of atmospheric vent stacks is believed to have little success unless vents are located very close together.

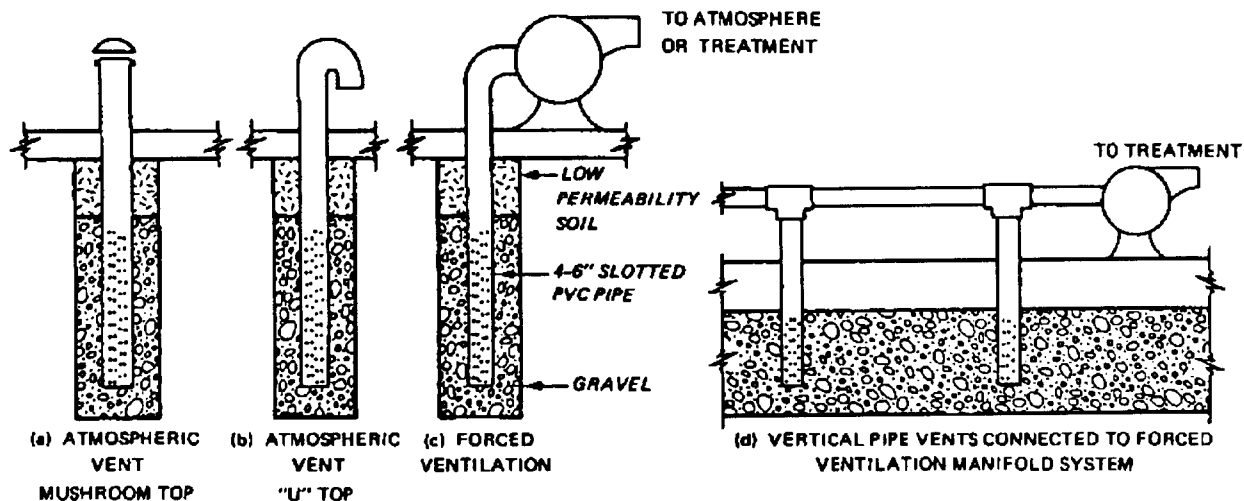

Figure 3-35. Design Configuration of Pipe Vents

(2) Trench vents.

(a) Trench vents are used primarily to attenuate lateral gas or vapor migration. They are most successfully applied to sites where the depth of gas migration is limited by ground water or an impervious formation. If the trench can be excavated to this depth, trench vents can offer full containment and control of gases and vapors.

(b) As with pipe vents, the applicability of different trench vent systems depends on whether methane generation is occurring or whether the problem at the site is limited to the control of toxic vapors. Passive open trenches (drawings (a) and (b) in Figure 3-36) may be applicable to the control of toxic vapors in an emergency situation where immediate relief is required. They also can be employed as a permanent control for methane migration; however, their efficiency is expected to be low. An impervious liner can be added to the outside of the trench to increase control efficiency. Open trenches are more suitable for sparsely populated areas where they will not be accidentally covered, planted over, or otherwise plugged by outsiders.

(c) Passive trench vents may be covered over by clay or other impervious materials and vented to the atmosphere. Such a system ensures adequate ventilation and prevents infiltration of rainfall into the vent. Also, an impervious clay layer can be used as an effective seal against the escape of toxic vapors.

b. Design and Construction Considerations.

(1) Vent stacks.

(a) When designing installations of atmospheric pipe vents for methane control, proper placement of vent stacks is the chief consideration. Preliminary sampling should be conducted to determine gas collection points for proper vent placement. Methane concentrations vary widely depending on the specific landfill configuration. The highest methane concentration (70 percent is the theoretical limit) is expected in the most anaerobic section of the filled material. In many cases, this is at the bottom of the landfill. Optimum effectiveness will be obtained if vents are placed at maximum concentration and/or pressure contours. To ensure proper ventilation, vent depth should extend to the bottom of the fill material.

(b) Proper spacing of vents is important to ensure adequate ventilation of large areas where methane is concentrated. The distance between vents will depend on soil permeability; however, this distance can be estimated for a typical soil.

(c) A general rule to ensure adequate ventilation would be to locate wells 15.2 m (50 feet) apart. Atmospheric vent wells are not recommended for control of lateral migration of gas.

(d) Pipe wells are usually constructed of 100 to 150 mm (4- or 6-inch) PVC perforated pipe. Other material, such as galvanized iron, may be required if PVC is not compatible with the waste materials. A surrounding layer of gravel pack should be installed to prevent clogging. The pipe vent should be sealed off from the atmosphere with a cement or cement/soil grout so that excess air is not introduced into the system, and methane or volatile toxics cannot be leaked. Pipe vents may be installed through a clay cap, as shown in Figure 3-36(c and d) to prevent emission of gases or vapors to the atmosphere.

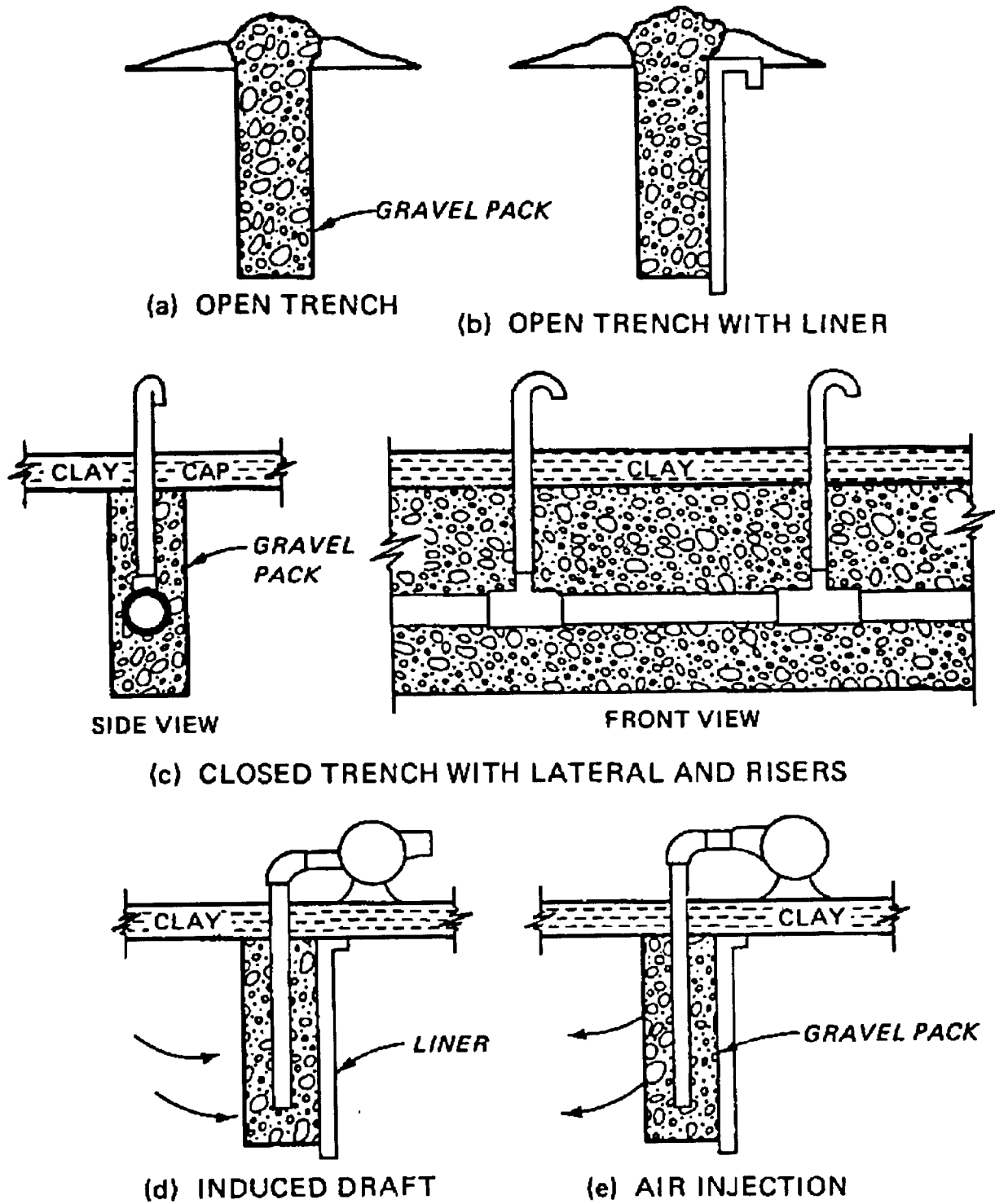

Figure 3-36. Design Configuration of Trench Vents

(2) Trench vents.

(a) Open vents are subject to infiltration by rainfall run-off and could become clogged by solids. Hence, they should not be located in an area of low relief. It is advisable to construct a slope with some of the excavated soil to direct run-off away from the trench as in drawings (a) and (b) of Figure 3-36. Also, if possible, open trenches should be constructed within controlled areas to prevent any safety or vandalism problems.

(b) The gravel pack in the trench will be permeable enough, relative to the surrounding strata, to transport the gas adequately. Also, in areas of relatively high permeability or wherever safeguards are needed, a liner should be installed on the outside of the trench to prevent bypass.

(c) In passive closed trench vents, good ventilation can be ensured by proper design of laterals and risers. One successful design consisted of 300 mm (12-inch) perforated corrugated lateral pipe with 2.4 m (8-foot) corrugated risers spread at 15.2 m (50-foot) intervals.

(d) There are three types of impervious liners for containing gas flow: synthetic liners, admixed materials, and natural soil. Synthetic liners are manufactured using rubber or plastic compounds. Polyvinyl chloride liners are frequently used because they are more impermeable to methane when compared to polyethylene and are relatively inexpensive. The membranes must be put down as to avoid punctures, and usually layers of soil or sand must be placed on both sides. Admixed materials such as asphaltic concrete have the advantages of being universally available, relatively inexpensive, and can maintain their integrity under structures. However, they are more permeable than synthetic membrane liners, and they have a tendency to crack under differential settlement. Natural soil, particularly clay, can be used as a barrier to gas movement. Clay liners are inexpensive and readily available; however, the soil must be kept nearly saturated to be effective. Clay barriers like admixed materials have a tendency to crack under differential settlement and if exposed to air for prolonged periods will dry, shrink, and crack.

c. Advantages and Disadvantages. Passive vent stacks are an effective means of control when used in situations where gases freely migrate to a collection point and there is little or no lateral migration. Passive trench vents without a barrier are not very effective in controlling migrating gases. The addition of an impermeable liner may offer the required degree of effectiveness; however, the installation of a liner will generally be economical only if the required depth is 3 m (10 feet) or less. Trench vents may become plugged by soil particles with time, thereby reducing their long-term effectiveness.

3-28. Active Control Systems. Active gas control systems can be divided into extraction and pressure systems. Both systems will usually incorporate some type of impermeable gas barrier system. Extraction systems usually incorporate a series of gas extraction wells installed within the perimeter of the landfill. Extraction wells are similar to gas monitoring wells, only larger, and construction and materials are the same. The number and spacing

needed for the extraction wells for any particular landfill are site dependent. Often a pilot system of only a few wells will be installed first to determine the radius of influence in the area of the wells. Once the wells are installed, they are connected using gas valving and condensation traps to a suction system. A centrifugal blower creates a vacuum on the manifold, drawing gas from the wells and causing the gas in the refuse and soil to flow toward each well. Depending on the location, the gas is either exhausted to the atmosphere, flared to prevent malodors, or recovered and treated. A pressure gas control system is sometimes considered when structures are built or already exist on abandoned landfills. The system uses a blower to force air under the building's slab to flush away any gas that has collected and develop a positive pressure to prevent gas from migrating toward the structure.

a. Application.

(1) Methane migration control can be more effectively accomplished by installing forced-ventilation systems in which a vacuum pump or blower is connected to the discharge end of the vent pipe. A drawdown with a radius of influence of 45.7 m (150 feet) can be accomplished with a pumping rate of 23.6 liter/sec (50 cubic feet per minute) dependent upon soil type, compaction, and other site conditions. Such a system is applicable for controlling both vertical and lateral movement of methane in the landfill by installing vents along the perimeter of the site. The collected gas and vapor can be vented to the atmosphere, flared, or recovered and treated.

(2) In landfills containing volatile toxics, a closed forced-ventilation system is required to prevent any toxic vapors from migrating laterally or vertically through the cover material to the atmosphere. Figure 3-36, section (d), depicts a series of pipe vents installed in a trench connected to a manifold that leads to a blower and finally to gas treatment. Such a configuration can be used to prevent emission of toxics to the atmosphere across the entire area of the site. A forced-ventilation system utilizing a series of extraction wells is illustrated in Figure 3-37.

(3) Another type of forced ventilation in a trench for methane migration control is air injection; in this method, air injected into the trench by a blower forces the gas or vapor back. This system should work well in conjunction with pipe vents installed close to the landfill and inside the circumferences of the trench.

b. Design and Construction Considerations.

(1) Forced ventilation is a more effective means of controlling the lateral and vertical migration of methane or toxic vapors. The flow rate for venting should be high enough to collect all gases being generated, i.e., it should be at least equal to the gas generation rate. Also, the flow rate should be high enough to ensure a fairly large radius of influence, so as to minimize the number of wells needed to vent the area. Blowers, pumps, etc., should be explosion-proof for this type of application.

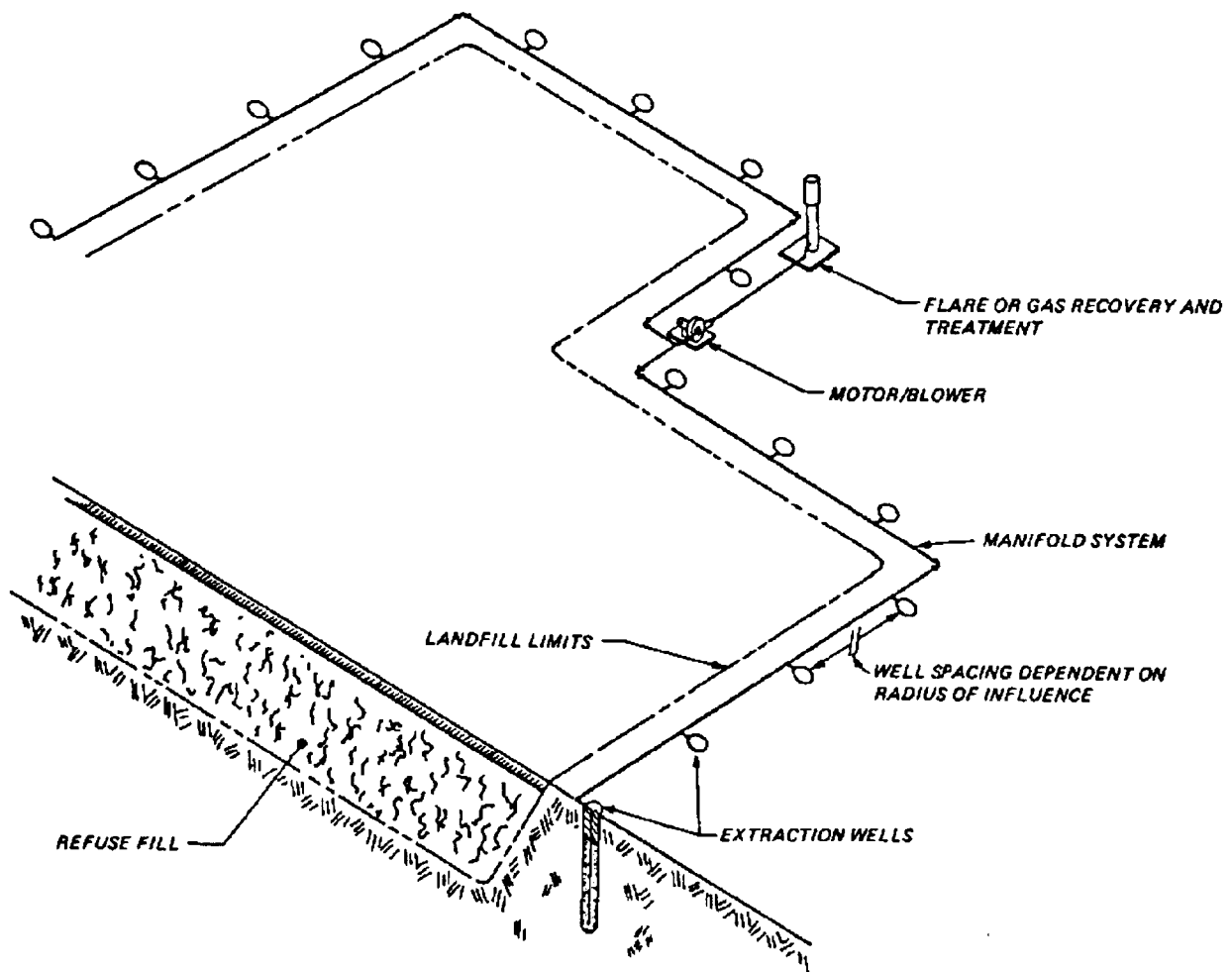

Figure 3-37. Forced-Ventilation System for Landfill Gas Control

(2) Studies at three municipal landfills in California indicated a range in gas production rates from 22 to 45 milliliters per kilograms of refuse per day. Assuming a bulk density of 250 kilograms per cubic meter for ground domestic garbage, these values convert to a range of 5.5 to 11.25 liters per cubic meter per day. If the average anaerobic layer of the fill is assumed to be 10 meters, then 55 to 113 liters of methane per day per square meter of fill area can be expected. This translates to a ventilation requirement of at least 6 to 11 cubic feet per minute per acre. In an actual demonstration for recovering methane from a municipal landfill, a steady state flow was obtained at 23.6 l/s (50 cubic feet per minute) with the radius of influence at about 39.6 m (130 feet). This translates to a ventilation rate of 128 l/s/hectare (107 cubic feet per minute) per acre, which means a substantial portion of excess air was introduced into the system. However, it was determined that methane production was not inhibited by this amount of air, and maximum oxygen levels in the gas were only 4 percent.

(3) Diffusion rates for volatile toxics can be calculated to determine requirements for ventilation of hazardous waste landfills. However, these estimates need more field verification.

(4) When designing a forced ventilation system for a trench, pipes can probably be placed at greater distances than extraction wells since the trench fill is composed of very permeable material. If a liner is used, the spacing can be at even greater distances since the normal radial influence of the pipes will be channeled along the trench.

d. Advantages and Disadvantages. Atmospheric vents are effective means of control when used in situations where gases freely migrate to a collection point and there is little or no lateral migration. Forced ventilation is a very effective method for controlling migration of gas and toxic vapors. If forced ventilation is used, the flow rate can be increased or decreased as the gas generation or vapor flux rate increases or decreases. This offers a great deal of flexibility of control inherent in the system. At a hazardous waste site where volatile toxics are present, the mass flux rate will decrease with time as the volatiles are dissipated. Thus, ventilation rates can be reduced with time and operating costs will decrease. It is expected that gas vents from forced ventilation are more apt to clog after time, and will need to be replaced. Also, it is expected that more maintenance will be required for forced ventilation than for passive atmospheric vent systems.

CHAPTER 4

TREATMENT TECHNOLOGIES

4-1. Applicability. This chapter provides descriptive information on state-of-the-art design methodology for the treatment of industrial and hazardous waste. The information presented is applicable for the planning level design of remedial action treatment systems. The process designs described must be adjusted for site-specific conditions to ensure appropriate technology application.

4-2. Techniques. Because hazardous waste treatment must consider so many materials and conditions, good reliable treatability data are essential. Considerable information is available in the literature that can be used in planning level designs and should be extracted and compiled under one cover. However, final designs must be based upon field data ascertained from bench and/or pilot plant scale testing of specific waste streams. EPA Guidance Manual Guide for Conducting Treatability Studies under CERCLA gives an excellent coverage of this area.

Section I. Treatment of Liquid Waste Streams

4-3. Definitions. Liquid waste streams include leachates, ground water, surface water, concentrated hazardous wastes, and effluents resulting from other treatment technologies such as incineration or soil washing. The technologies presented in this section are commonly used for the treatment of liquid waste streams.

4-4. Air Stripping. Air stripping removes volatile contaminants from an aqueous waste stream by passing air through the wastes. This process can be accomplished either in a stripping lagoon or in a packed column. When air is passed through the waste the volatile dissolved gases are transferred to the air streams for possible collection and treatment in the case of a packed column, if the air stream is considered hazardous. Figures 4-1 and 4-2 illustrate both processes. The major factors affecting performance and design include pH, temperature, Henry's law constant of the chemicals to be stripped, airflow, hydraulic loading, and column packing depth and spacing. The process requires a high pH, 10.8 to 11.5 for ammonia stripping, and increased airflow as the temperature of the influent stream decreases.

a. Applications. Air and steam stripping have been used to remove volatile organic compounds (phenol, vinyl chloride, etc.) and compounds with relatively high vapor pressure and low solubility such as chlorinated hydrocarbons from waste streams. Air stripping has been directly applied to ground-water treatment in removing trichloroethylene (TCE), trihalomethane (THM), and hydrogen sulfide. Removal rates as high as 99 percent for TCE from ground water have been seen. Air stripping has been widely used to remove ammonia from wastewaters with removal efficiencies exceeding 90 percent.

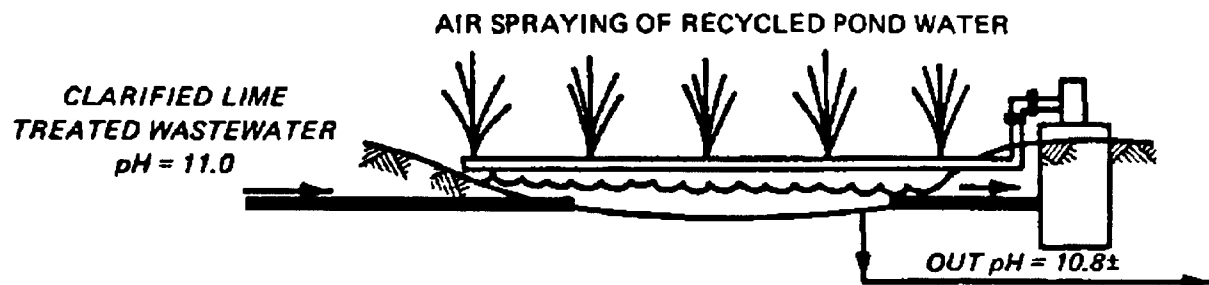

Figure 4-1. Ammonia Stripping Lagoon (Source: EPA 1978)

b. Advantages/Disadvantages. The advantages and disadvantages of air stripping are summarized below.

Advantages	Disadvantages
Can reduce levels of volatiles by over 90 percent	Cost prohibitive to operate at temperatures below freezing
Process is relatively independent of volatile concentration	Sensitive to pH, temperature, and fluxes in hydraulic load
Can reduce TCE concentrations by 99 percent	May pose potential air pollution problems requiring permitting, recovery, and treatment if hazardous volatile organic compounds are present in waste stream

c. Data Requirements. An air stripping system requires the following data.

- (1) Feed stream characteristics.
 - (a) Average water flow, Q , m^3/d (mgd).
 - (b) Peak water flow, m^3/d (mgd).
 - (c) Water temperature, T , $^{\circ}C$ ($^{\circ}F$).
 - (d) Contaminant concentration in water, X_0 , mg/l
 - (e) pH of water.
- (2) Effluent stream characteristics (contaminant concentration, X , mg/l).
- (3) Design decisions.

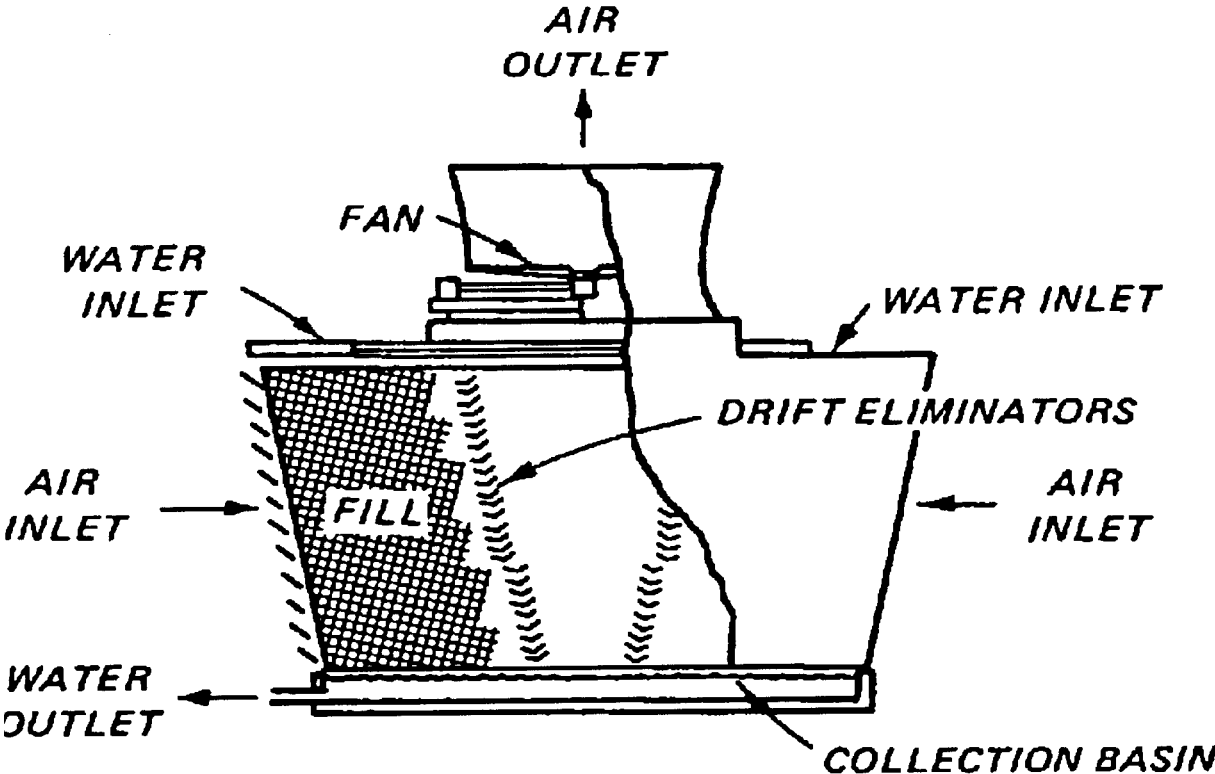

CROSS-FLOW TOWER

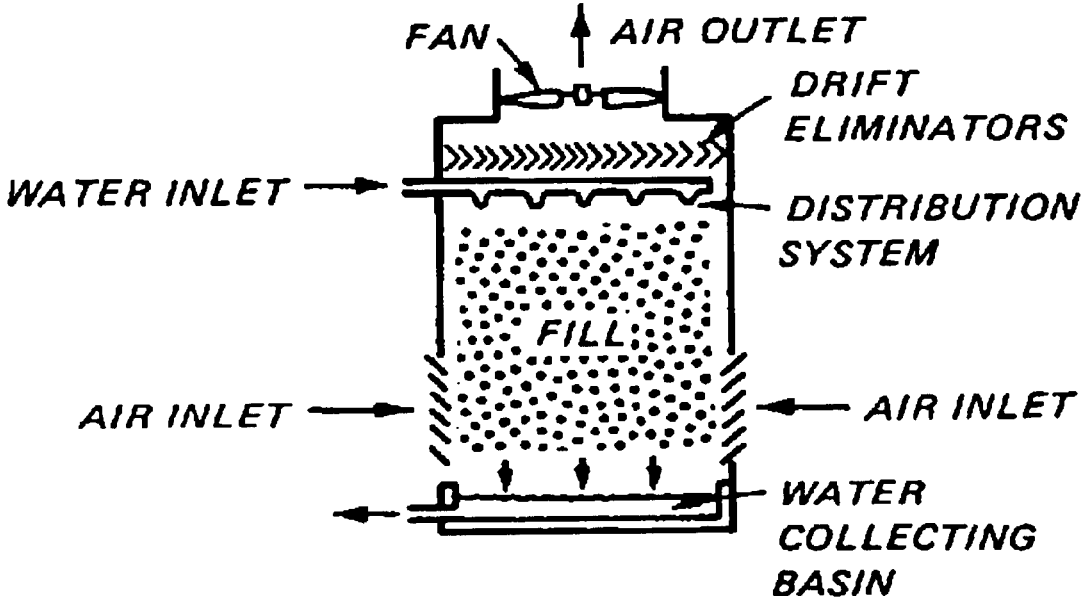

COUNTERCURRENT TOWER

Figure 4-2. Ammonia Stripping Tower

- (a) Liquid loading rate, L, lb H₂O/hr/sq ft (Kg H₂O/hr/m²).
- (b) Gas loading rate, G, lb air/hr/sq ft (Kg/hr/m²).
- (c) Tower width, W, or diameter, D, ft (m).
- (d) Excess capacity factor.
- (4) Packing characteristics (from manufacturer).
- (a) Packing height of a transfer unit versus gas/liquid ratio (G/L), ft (m).
- (b) Height of a transfer unit for cooling versus gas and liquid loading rates, ft (m).
- (c) Pressure drop characteristics as function of gas loading.
- (5) Henry*s law. Constants for chemicals to be stripped, H, atm.
- d. Design Criteria.

(1) Air stripping can be carried out either in a stripping lagoon or in a packed column. The major factors affecting performance and design include pH, temperature, airflow, hydraulic loading, and tower packing depth and spacing. Cost and performance are relatively independent of influent ammonia concentrations. For materials like ammonia, the pH must be raised to a point where all or nearly all ammonia is converted from ammonium ion NH₄⁺ to NH₃ gas. The pH for efficient operations varies from about 10.8 to 11.5. Where lime precipitation is part of a treatment scheme, it is advantageous to locate the ammonia stripping unit after lime precipitation to take advantage of the high pH in the clarifier effluent.

(2) As water temperature decreases, it becomes more difficult to remove volatiles by stripping. The amount of air per gallon (m³) must be increased to maintain removal as temperature decreases. It is impractical to heat stripping units when the temperature reaches freezing.

(3) The hydraulic loading rate in a packed tower is a critical factor in determining performance. If hydraulic loading becomes too high, good drop-let formation needed for efficient stripping is disrupted. If the rate is too low, packing may not be properly wetted, resulting in poor performance and formation of scale. To determine the packing height required in an air stripping column use equation 4-1.

$$Z_T = \frac{L}{K_{La}} * \frac{r}{(R-1)} * \ln \frac{X_T/X_B * (R-1) + 1}{R} \quad (4-1)$$

where

Z_T = packing height, m (ft)

L = liquid loading rate, kg/hr/m² (lb H₂O/hr/sq ft)

X_T = contaminant influent concentration, mg/l

X_B = contaminant effluent concentration, mg/l

K_{La} = mass transfer coefficient

$$\frac{K_{La}}{D} = \alpha \left(\frac{L}{\mu_L} \right)^{1-n} \left(\frac{\mu_L}{\rho_L D} \right)^{0.5}$$

where

μ_L = liquid viscosity, kg/m/hr (lb/ft/hr)

D_L = density of liquid, kg/m³ (lb/ft³)

D = diameter of column, m (ft), determined experimentally

R = stripping factor

$$R = \frac{G * P_a / M_a}{L * P_w / M_w} * \frac{H}{P_T}$$

where

G = air loading rate, kg/hr/m² (lb/hr/sq ft)

P_a = air density, 1.205 g/m³ @ 20 °C (0.075 lb/ft³ @ 70°F)

M_a = molecular weight of air, 28.84, gmw

P_w = liquid density, 998.2 kg/m³ @ 20 °C (62.3 lb/ft³ @ 70 °F)

M_w = molecular weight of water, 18, gmw

H = Henry*s law constant, atm

P_T = operating pressure, atm, 1.0 at sea level

(4) Where ammonia concentrations are high (in excess of 100 mg/l), it may be attractive both economically and environmentally to recover the ammonia in an adsorption tower. With good countercurrent contact, 90 to 95 percent of

the ammonia can be transferred to the adsorption solution. Figure 4-3 illustrates the ammonia removal and recovery process.

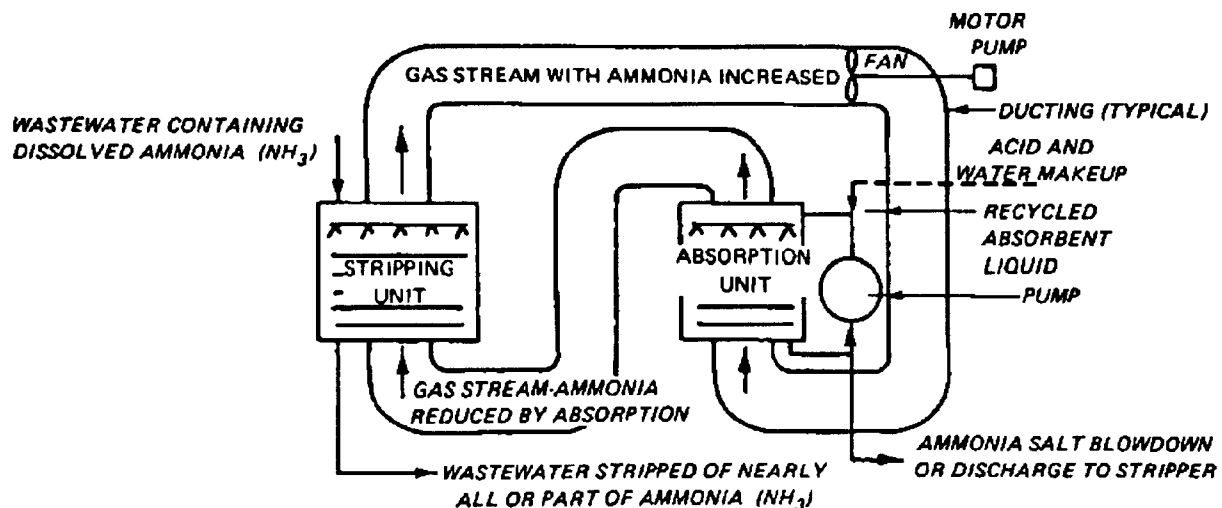

Figure 4-3. Ammonia Stripper and Recovery System

(5) When used for treatment of waters containing volatile organics, air stripping results in off gases that may exceed regulatory criteria. Off gas treatment systems such as activated carbon or thermal destruction using incineration or catalytic oxidation may be required.

4-5. Biological Treatment.

a. Background.

(1) The major objectives of biological treatment of leachate and contaminated ground water are to reduce the dissolved organic content, to remove heavy metals and nutrients such as nitrogen and phosphorus, and to coagulate and remove colloidal solids. The major treatment effects are caused by incorporation of these materials into microorganisms* tissues. The microorganisms can either be attached to media (trickling filters, rotating biological contactors, or anaerobic filters), or settled out and discarded (lagoons and stabilization ponds), or recycled (activated sludge systems). The biological unit processes are listed in Table 4-1.

(2) Most organic chemicals are biodegradable, although the relative ease of biodegradation varies widely. With properly acclimated microbial populations, adequate detention time, and equalization to ensure uniform flow, biological treatment can be used to treat many organics. There is considerable flexibility in biological treatment because there are several available processes, and microorganisms are remarkably flexible. Several generalizations can be made about the biological treatment of organics:

Table 4-1. Summary of Biological Treatment Processes

Treatment method	Feed stream requirements and limitations	Major design and performance criteria	Environmental impact	Technology status	Reliability
Activated sludge	Can handle BODs of 10,000 mg/ℓ (10,000 ppm) Required low level of suspended solids--usually 1 percent Oil and grease should be less than 50 mg/ℓ	Detention time Organic load Food-to-microorganism ratio Aeration	Generates excess sludge containing refractory organics and metals that have been sorbed	Highly developed; widely used	Process reliability is very good in absence of shock loads
Pure oxygen-activated sludge	Effective for readily degradable organics or organics to which it can be acclimated Sensitive to heavy metals Requires suspended solid levels of about 1 percent or less Can handle higher organic loads than conventional activated sludge and is more tolerant of shock loads Sensitive to heavy metals and oil and grease	Detention time Organic load Food-to-microorganism ratio Oxygen requirements	Generates sludge containing refractory organics and sorbed metals	Relatively new technology but demonstrated for some industrial wastewaters	Reliability fully established; complex and requires high level of maintenance

(Continued)

Table 4-1. (Continued)

Treatment method	Feed stream requirements and limitations	Major design and performance criteria	Environmental impact	Technology status	Reliability
Aerobic, anaerobic, aerated, or facultative	Requires very low suspended solids (0.1 percent) Requires low strength organic wastes (except anaerobic)	Detention time Depth Organic load Ph Oxygen levels	May create odors; may release volatiles, H ₂ S, and methane if anaerobic; must be lined to prevent seepage into ground water	Well demonstrated for stabilization of organics but not widely used	High if proper Ph maintained and organic load is low; sensitive to shock loads since no sludge recycled
Rotating biological contactor	Suitable for treatment of readily degradable organics; can handle higher organic loads than trickling filter but lower than activated sludge Better suited to treatment of suspended or colloidal organics rather than soluble	Detention time Hydraulic load Organic load Temperature	Generated sludge containing refractory organics and sorbed metals; may cause odors	Process is relatively new, not widely used but gaining in popularity	Moderate in the absence of high organic loads and temperatures below 12.8 °C (55 °F)
	Sensitive to oil and grease and metals				

(Continued)

Table 4-1. (Concluded)

Treatment method	Feed stream requirements and limitations	Major design and performance criteria	Environmental impact	Technology status	Reliability
Trickling filter	Can handle only very low organic loads as compared to activated sludge	Media type Hydraulic load	Generates sludge that contains refractory organics and sorbed metals; causes odors	Widely used as a roughing filter for industrial wastes	Fair for secondary treatment; moderate as a roughing filter
	Better suited to treating suspended and colloidal organics rather than soluble ones	Organic load Bed depth Temperature			
	Sensitive to metals and oil and grease	Recirculation			

(a) nonaromatic (noncyclic) hydrocarbons are more easily treated than aromatics;

(b) materials with unsaturated bonds, such as alkenes, are more easily treated than materials with saturated bonds;

(c) stereochemistry affects the susceptibility of certain compounds to attack

(d) soluble organics are usually more readily degraded than insoluble materials; dissolved or colloidal materials are generally more readily degraded than insoluble materials. Dissolved or colloidal materials are more readily attacked by enzymes; and

(e) the presence of key functional groups at certain locations can affect the degradation rate of compounds; alcohols, for example, are more easily degraded than their alkane or alkene homologues. On the other hand, addition of a Cl group or an NO₂ group increases resistance to biodegradation.

(3) Although many compounds in leachate and contaminated ground water may be resistant at first to biological treatment, microorganisms can be acclimated to degrade many of these. Similarly, while heavy metals hinder biological treatment, the biomass can also be adjusted, within limits, to tolerate higher concentrations of metals. Concentrations of metals above which the treatment efficiency of biological processes may lessen are as follows:

<u>Material</u>	<u>Inhibitory threshold (mg/l)</u>
Ammonia	480
Arsenic	0.1
Cadmium	1 to 5
Calcium	2500
Chromium (+3)	10
Chromium (+6)	1 to 10
Copper	1 to 10
Iron (+3)	15
Lead	10
Manganese	10
Mercury	0.1 to 5
Nickel	1 to 2.5
Silver	0.03
Vanadium	10
Zinc	1 to 10

b. Suspended Growth (Activated Sludge). Activated sludge is a heterogeneous suspended growth microbial culture composed largely of bacteria, protozoa, rotifers, and fungi. The bacteria are responsible primarily for assimilating most of the organic material from the waste; the protozoa and rotifers complete the process by removing the dispersed bacteria that otherwise would escape in the plant effluent, giving high COD and suspended solids. Aeration can be by air or by pure oxygen. Activated sludge systems are usually made up of several unit processes, including primary sedimentation, an aerated reactor with sludge recycle, and clarification in a settling tank. A diagram of a typical activated sludge system is presented in Figure 4-4.

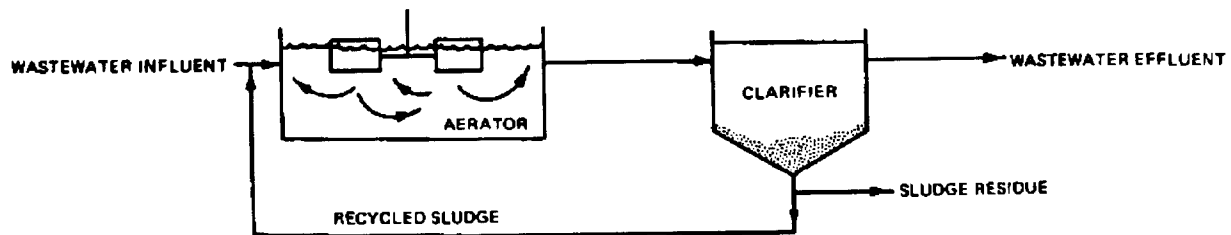

Figure 4-4. Typical Activated Sludge System (Source: Arthur D. Little, Inc. 1976).

(1) Applications.

(a) The air-activated sludge process has proven effective in the treatment of industrial wastewaters from refineries and coke plants, or pharmaceutical wastes, PVC wastes, and food processing wastes. Conventional activated sludge has treated petroleum wastes with a BOD₅ as high as 10,000 ppm.

(b) The process has also been reasonably well demonstrated for the treatment of leachate from municipal landfills. At the GROWS landfill in Bucks County, Pennsylvania, BOD removal of over 98 percent was achieved for an influent concentration of almost 5,000 milligrams per liter. Treatment included physical/chemical as well as biological treatment. Experiments have shown that activated sludge is generally well suited to treatment of high strength leachates containing high concentrations of fatty acids. As the landfill stabilizes, the ratio of BOD/COD decreases and the wastes become less amenable to biological treatment.

(c) The activated sludge process is sensitive to suspended solids and oil and grease. It is recommended that suspended solids be less than one percent. Oil and grease must be less than 75 milligrams per liter, and preferably less than 50 milligrams per liter, for effective treatment.

(2) Advantages/disadvantages. The advantages and disadvantages of both air- and pure-oxygen-activated sludge treatment are summarized below:

<u>Advantages</u>	<u>Disadvantages</u>
Activated sludge has been widely used in industrial waste water treatment	Capital costs are high
Numerous process variations which allow for high degree of flexibility	Process is sensitive to suspended solids, fats and oils, and metals
Process reliability is good (although not well known for pure-oxygen-activated sludge)	Generates sludge which can be high in metals and refractory organics
Can tolerate higher organic loads than most biological treatment processes	Subject to upsets from shock loads
	Fairly energy intensive
	O&M intensive

(3) Data requirements. Principal data requirements for the design of a activated sludge system include:

- (a) Specific BOD reaction rate coefficient (for retention time).
 - (b) Oxygen coefficients (for oxygen requirements).
 - (c) Sludge coefficients (biodegradable fraction).
 - (d) Biodegradable sludge fraction.
 - (e) Oxygen transfer coefficient.
 - (f) Standard oxygen transfer efficiency.
 - (g) Oxygen saturation coefficient.
 - (h) Temperature correction coefficient.
 - (i) Average and maximum influent flow.
 - (j) Influent temperature.
 - (k) Extreme ambient temperature, summer and winter.
 - (l) Average and maximum influent BOD.
 - (m) Influent suspended solids.
- (4) Design criteria.

(a) Key design parameters for activated sludge include aeration period of detention time; BOD loading per unit volume, usually expressed in terms of pounds BOD applied per day per g BOD/m² (1,000 cubic feet) of aeration basin;

and the food-to-microorganism ratio (F/M), which expresses BOD loading with regards to microbial mass (MLVSS). There are several modifications of the activated sludge process that may be used depending upon the BOD loading and the required treatment efficiency. Table 4-2 summarizes the loading and operational parameters for aeration processes that may be applicable to treatment of hazardous leachate.

(b) Even though conventional treatment has limitations such as poor tolerance for shock loads, a tendency toward producing bulking sludge that results in high suspended solids in the effluent, and low acceptable BOD loadings, these problems can be alleviated to varying extents with variations in process design. The completely mixed activated sludge (CMAS) modification of the process (Table 4-2) is the most widely used for treatment of waste-waters with relatively high organic loads. The advantages of this system are:

! Less variation in organic loading, resulting in more uniform oxygen demand and effluent quality.

! Dilution of the incoming wastewater into the entire basin, resulting in reduced shock loads.

! Uses the entire contactor contents at all times because of complete mixing.

(c) The extended aeration process involves long detention times and a low F/M ratio (0.1). Process design at this low F/H ratio results in a high degree of oxidation and a minimum of excess sludge. The contact stabilization process--in which biological solids are contacted with the wastewater for short periods of time, separated, and finally aerated to degrade absorbed organics--has shown some success for industrial wastes with a high content of suspended and colloidal organics. Pure oxygen systems have resolved several major drawbacks of conventional treatment. Pure oxygen systems show increased bacterial activity, decreased sludge volume, reduced aeration tank volume, and improved sludge settling. The pure oxygen process has been demonstrated to be applicable to a wide range of wastes at high F/M ratios. Such wastes streams include: petrochemical, dye, pharmaceutical, and pesticide wastes.

(d) In addition to process variations, there are several measures available for minimizing process upsets and maximizing stability:

! The deleterious effects of hydraulic and organic load variations can be minimized by equalization preceding biological treatment.

! A commonly used method for providing increased biodegradation is to increase the inventory of biological solids in the aeration basin by increasing the sludge-recycle ratio or reducing sludge wastage. However there is usually a tradeoff to such an approach. Higher sludge quantities lead to increased need for food and air. Also, old heavy sludge tends to become mineralized and devoid of oxygen, creating a less active floc. The rate of return sludge may vary from 35 to 50 percent in systems carrying a low MLSS concentration (approximately 2,000 milligrams per liter) and from 75 to 100 percent in systems carrying higher MLSS.

Table 4-2. Summary of Operating Parameters for Air-Activated Sludge and Pure-Oxygen-Activated Sludge

Process mobilization	Aeration system	BOD loading g BOD/m ³ (1b BOD/ 1,000 ft ³)	FM ratio g BOD/day g MLVSS (1b BOD/day 1b MLVSS)	Mixed liquor suspended solids (mg/l)	Applications and limitations
Conventional	Diffused air, mechanical aerators	320-640 (20-40)	0.2-0.4 (no conver- sion required)	1,500-3,000	Low strength wastes; subject to shock load
Step aeration	Diffused air	640-960 (40-60)	0.2-0.4	2,000-3,500	Flexible and generally applicable to a wider range of wastes than conventional treatment. Uses lower volumes of air and shorter detention times than conven- tional processes, but can handle higher BOD loads
Complex-mix	Diffused air, mechanical aerators	800-1920 (50-120)	0.2-0.6	3,000-6,000	Resistant to shock loads, gener- ally applicable
Extended aeration	Diffused air, mechanical aerators	160-400 (10-25)	0.05-2.0	3,000-6,000	Requires long detention times and low organic load; produces low volume of sludge; available as package plant
Contact stabilization	Diffused air, mechanical	960-1200 (60-75)	0.2-0.6	1,000-3,000 ¹ 4,000-10,000 ²	Low aeration requirements; not suitable for soluble BOD

(Continued)

¹ Contact unit.

² Solids stabilization unit.

(Source: Hammer 1975, Metcalf and Eddy, Inc. 1972, Nemerow 1978).

Table 4-2. (Concluded)

Process mobilization	Aeration system	BOD loading g BOD/m ³ (lb BOD/ 1,000 ft ³)	FM ratio		Mixed liquor suspended solids (mg/l)	Applications and limitations
			g BOD/day g MLVSS (lb BOD/day lb MLVSS)	(no conversion required)		
High rate	Mechanical aerators	1280+ (80+)	0.5-1.0 (no conversion required)	4,000-10,000	Well suited to shock loads; requires little supervision. However, requires long detention times, requiring three times as much air as conventional treatment	
Pure-oxygen	Mechanical aerators	1920+ (120+)	0.6-1.5	6,000-8,000	High efficiency possible at increased BOD loads and reduced aeration	

! Suspended solids should be reduced as much as possible by sedimentation or filtration.

! Since kinetics of biological degradation are concentration-dependent, dilution can minimize process upsets under some conditions.

! Sludge bulking, which leads to poor effluent quality, can be controlled by pH adjustment, sufficient aeration, and adequate nutrient supply. An important consideration for leachate treatment is that microbial growth is a function of the limiting nutrient. Some leachates may be phosphorus or nitrogen limited. Requirements for nitrogen and phosphorus are generally

$N = 5 \text{ kg}/100 \text{ kg BOD}_5 \text{ (5 lb}/100 \text{ lb BOD}_5\text{) removed}$

$P = 1 \text{ kg}/100 \text{ kg BOD}_5 \text{ (1 lb}/100 \text{ BOD}_5\text{) removed}$

(e) Equipment used for activated sludge treatment varies considerably, but the major types of aerators are mechanical surface, diffuse air, and sparged turbine aerators.

! Mechanical surface aerators are most economical but have the lowest transfer rates.

! Compressed air diffusers: Coarse air diffusers have lower energy requirement and lower gas transfer efficiency. Fine air diffusers have higher energy requirement and higher gas transfer efficiencies.

! Sparged turbine aerators use most energy but have best gas transfer efficiency. This form of diffused air is very fine and benefits from improved gas transfer kinetics.

(f) Secondary clarifiers are used to separate activated sludge solids from the mixed liquor and to produce concentrated solids for the return flow required to sustain biological treatment. Average hydraulic loading varies from 1.6 to 3.3 m³/day/m² (400 to 800 gallons per day per square foot) and peak loadings range from 2.9 to 4.9 m³/day/m² (700 to 1,200 gallons per day per square foot), depending on MLSS concentration and percent sludge recycle. Average solids loading of 2.9 to 5.9 kg/hr/m² (0.6 to 1.2 pounds per hour per square foot) and peak loadings of 6.1 to 9.8 kg/hr/m² (1.25 to 2.0 pounds per hour per square foot) are typical for activated sludge plants. Depths are normally 3.7 to 4.6 m (12 to 15 feet).

c. Fixed Film (Trickling Filter). Trickling filters are a form of biological treatment in which a liquid waste of less than 10,000 mg/l suspended solids is trickled over a bed of rocks or synthetic media upon which a slime of microbial organisms is grown. The microbes decompose organic matter aerobically; these conditions are maintained at the outer slime surface by updrafts of air. Some anaerobic decomposition may occur at the interior surface adjacent to the trickling bed media. Periodically, the slime layer sloughs off due to the weight of the microbial growth or the hydraulic flow rate of the effluent. A schematic diagram of a typical trickling filter treatment system appears in Figure 4-5.

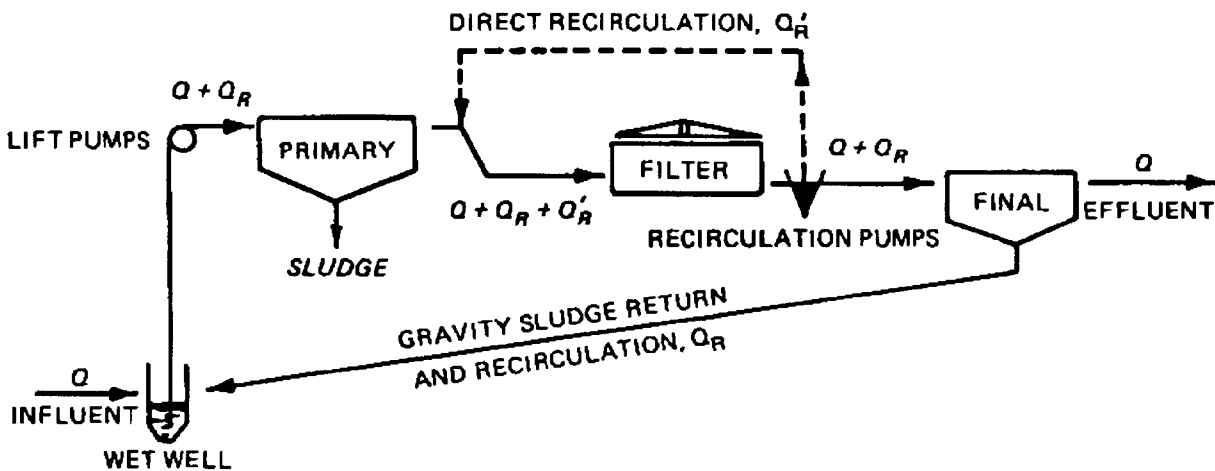

Figure 4-5. Trickling Filter Recirculation (Source: Hammer 1975, EPA 1982)

(1) Applications.

(a) Trickling filters are well suited to treatment of low flow waste streams and are often used as roughing filters to reduce organic loads to a level suitable for activated sludge treatment. Trickling filters are currently used in conjunction with other treatment methods to treat wastewaters from refineries, pharmaceuticals, pulp and paper mills, etc. Efficiency of trickling filters in the treatment of refinery and petrochemical wastes ranges from 10 to 20 percent when used as a roughing filter to 50 to 90 percent when used for secondary treatment. The process is more effective for removal of colloidal and suspended materials than it is for removal of soluble matter.

(b) Because of the short hydraulic residence time on the filter material, biodegradation along the filter media is generally insufficient as the sole means of biological treatment. For concentrated wastes, a high rate of recirculation would be required for significant reduction of organics. The short residence time, however, has the advantage of allowing greater variations in influent waste composition as compared with activated sludge or anaerobic digestion. By placing a trickling filter in sequence with activated sludge treatment, the filters could be used to equalize loading variations while the activated sludge would achieve the high removal efficiencies needed.

(2) Advantages/disadvantages. Advantages and disadvantages of trickling filters as compared to other biological treatment methods and nonbiological methods for removal of organics are as follows:

<u>Advantages</u>	<u>Disadvantages</u>
Because of short hydraulic residence times, process is not highly sensitive to shock loads	Vulnerable to below-freezing temperatures
Suitable for removal of suspended or colloidal matter	Limited treatment capability in a single-stage operation
Has good applicability as a roughing filter to equalize organic loads	Potential for odor problem
	Has limited flexibility and control
	Requires long recovery time if disrupted
	Requires large surface area compared with other biological treatment systems

(3) Data requirements. The data required for trickling filter design are generally the same as for activated sludge with the exception of no requirements for biodegradable sludge fraction, average MLVSS, and nonbio-degradable fraction. Summer and winter ambient conditions are required, these include:

- (a) Temperature.
- (b) Wind velocity.
- (c) Insolation-solar radiation.
- (d) Relative humidity.
- (4) Design criteria.

(a) The variables that influence design and performance of the trickling filter include: organic and hydraulic load, media type, nature of the waste, pH, and temperature. Trickling filters are classified according to their ability to handle hydraulic and organic loads. Typical design criteria for low and high rate filters are shown in Table 4-3. Use of plastic media filters with low bulk density has resulted in increased organic and hydraulic loading rates over those achieved with rock media filters. Plastic media filters have generally shown good performance under high BOD loading conditions that would not be tolerated by a conventional-type system because of clogging problems.

Table 4-3. Design Criteria for Trickling Filters

Design Parameter	Plastic media filter	High rate, rock media	Low rate, rock media
Hydraulic loading, m ³ /day/m ² (gal/day/ft ²)	2.9-5.7 (700-1,400) (secondary) 9.4-18.9 (2,300-4,600) (roughing filter)	.94-3.7 (230-900)	0.1-.37 (25-90)
Organic loading lb BOD/day/1,000 ft	10-50 (secondary) 100-500 (roughing filter)	20-60	5-20
Bed depth, ft	20-30	3-6	5-10
Media type	Plastic	1- to 5-in. rock	1- to 5-in. rock

(Source: EPA 1982).

(b) Recirculation is generally required to provide uniform hydraulic loading as well as to dilute high-strength waste waters. However, there is a limit to the advantage achievable with recirculation. Generally, recirculation rates greater than four times the influent rate do not increase treatment efficiency. Several recirculation patterns are available. One of the most popular is gravity return of the underflow from the final clarifier to a wet well during periods of low flow and direct recirculation by pumping filter discharge back to the influent as shown in Figure 4-5.

(c) Several formulas have been proposed which predict BOD removal efficiency based on waste type, influent BOD, hydraulic load, and other factors related to performance. Problems with these models include the need to determine treatability on a case-by-case basis and the fact that the models are usually applicable for only very specific conditions.

(d) The National Research Council (NRC) formulation to predict BOD removal efficiency was the result of an extensive analysis of operational records from stone-media trickling filter plants at military installations. The NRC data analysis is based on the fact that the amount of contact between the filter media and organic matter depends on the filter dimensions and the number of passes, and that the greater the effective contact, the greater will be the efficiency. However, the greater the applied load, the lower will be the efficiency. Therefore, the quantity that primarily determines efficiency in a trickling filter is a combination of effective contact and applied load. The efficiency through the first or single stage (E_1) and through the second stage (E_2) can be predicted from equations 4-2 and 4-3.

$$E_1 = \frac{100}{1 + 0.0085 \left(\frac{W_1}{VF} \right)^{\frac{1}{2}}} \quad (4-2)$$

$$E_2 = \frac{100}{1 + \frac{0.0085 \left(\frac{W_2}{VF} \right)^{\frac{1}{2}}}{1-E_1}} \quad (4-3)$$

where

E_1 = percent ROD removal efficiency through the first-stage filter and settling tank

W_1 = BOD loading (lb/day; 1 lb/day = 0.45 Kg/day) to the first- or second-stage filter, not including recycle

V = volume (acre-ft; 1 acre ft = 1,233.5 m³) of the particular filter stage (surface area times depth of media)

F = number of passes of the organic material, equal to

$$(1 + R/I) / [1 + (1 - P)R/I]$$

where R/I equals the recirculation ratio (recirculated flow/plant influent flow), and P is a weighting factor which, for military trickling filter plants, was found to be approximately 0.9

E_2 = percent BOD removal efficiency through the second-stage filter and settling tank

W_2 = BOD loading (lb/day) to the second-stage filter, not including recycle

(Note: Empirical equations, can only be used with English units - to use with metric, must convert to English before putting in Equation.)

(e) If recirculation is not being used, F will equal 1. It should be remembered that the NRC formulation was based on military waste water which is characteristically more concentrated than average domestic waste water. This could make the NRC formula more applicable to hazardous waste treatment. The effect of temperature on performance was not considered since most of the plants studied were in the middle latitudes of the United States.

d. Rotating Biological Disks. A rotating biological disk (RBD) is a fixed film biological method for treating effluent containing organic waste, similar in operating principle to trickling filters. A series of disks (1.8 to 3.0 in (6 to 10 feet) in diameter), or drums in some configurations, coated with a microbial film, rotate at 0.5-15 revolutions per minute through troughs containing the effluent; 40-50 percent of the disk surface area is immersed in the effluent while the uncovered portion of the disk exposes the microbial

film to the atmosphere during each rotation. Supplemental aeration is sometimes beneficial. The shearing motion of the disk through the effluent keeps the biological floc from becoming too dense. Periodic reversing of drum rotation is often used to control biological growth. The disks are usually arranged in series in groups of four. A schematic of a RBD is shown in Figure 4-6.

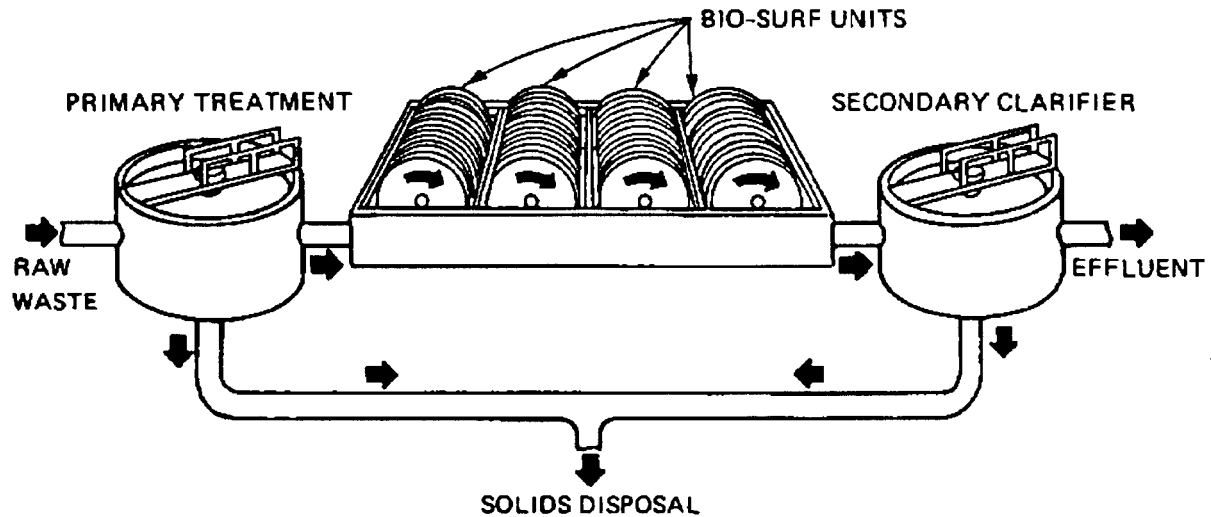

Figure 4-6. Rotating Biological Disk Treatment Schematic

(1) Applications. Rotating biological disks are currently being used at full scale to treat waste waters from the manufacture of herbicides, pharmaceuticals, petroleum, pulp and paper, and pigments and may have application for ground-water or leachate treatment at hazardous waste sites. They also have found use for domestic waste-water treatment. The process has only been used in the United States since 1969. Its modular construction, low hydraulic head loss, and adaptability to existing plants have resulted in growing use. The process can be used for roughing, nitrification, or secondary treatment.

(2) Advantages and disadvantages. Advantages and disadvantages of rotating biological disks as compared to trickling filters and activated sludge are summarized below:

<u>Advantages</u>	<u>Disadvantages</u>
Process has considerably more flexibility than trickling filters; both the intensity of contact between biomass and waste water and the aeration rate can be easily controlled by the rotational speed of the disks	Vulnerable to climate changes if not covered High organic loads may result in first-stage septicity and supplemental aeration may be required

(Continued)

<u>Advantages</u>	<u>Disadvantages</u>
Waste-water retention time can be controlled by selecting appropriate tank size; thus higher degrees of treatment can be obtained than with trickling filters	Odor may be a problem if septic conditions develop
In contrast to the trickling filter, biological disks rarely clog since shearing forces continuously and uniformly strip excess growth	As with trickling filters, biomass will be slow to recover if disrupted
As compared with activated sludge, rotating biological disks can handle large flow variations and high organic shock loads	Can handle only relatively low-strength wastes as compared with activated sludge
Modular construction provides flexibility to meet increased or decreased treatment needs	
Low O&M and energy requirements	
Requires small surface area when compared with other biological systems	

(3) Data requirements. The data required for the design of rotating biological disks are generally the same as for trickling filter design.

(4) Design criteria. For adequate treatment it is recommended that the process include four stages (disks) per train and the use of at least two parallel trains. Based on the design criteria, rotating biological disks can handle organic loads similar to a high-rate trickling filter. Typical design criteria include:

	<u>(Without nitrification)</u>	<u>(With nitrification)</u>
Organic Loading:	480-960 g BOD/m ³ (30-60 lb BOD/1,000 ft ³ media)	240-320 g BOD/m ³ (15-20 lb BOD/1,000 ft ³ media)
Hydraulic Loading:	3 × 10 ⁻³ to 6.1 × 10 ⁻³ m ³ /day/m ² (0.75 to 1.5 gal/day/ft ²)	1.2 × 10 ⁻³ - 2.5 × 10 ⁻³ m ³ /day/m ² (0.3-0.6 gal/day/ft ²)
Detention Time:	40-90 min	90-230 min

e. Lagoon Treatment. Lagoons or waste stabilization ponds are systems in which the processes of microbial oxidation, photosynthesis, and sometimes

anaerobic digestion combine to break down hazardous organic compounds. They are similar to activated sludge units without sludge recycling. Aeration may be supplied passively by wind and algae or, in aerated lagoons, by mechanical aerators or diffused air. The ecology of lagoons closely resembles a natural eutrophic lake, a more complex system than other biological treatment systems. A secondary benefit of lagoons is clarification. Physical and chemical treatment processes may also be carried out in lagoons. Figure 4-7 shows a flow diagram of an aerated lagoon, with a secondary clarifier. A separate clarifier may not be required with other lagoon designs, e.g., facultative lagoons, if the design includes a separate baffled settling compartment, two or more lagoons in series, or other special features.

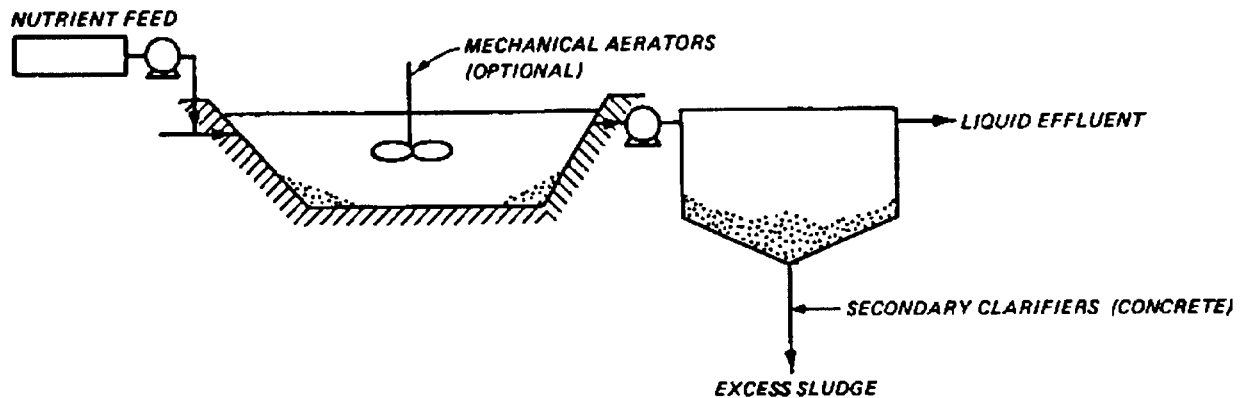

Figure 4-7. Aerated Lagoon (Polymeric-Lined Earth Construction)

(1) Applications. Waste stabilization ponds have been used to treat low-strength industrial wastes, landfill leachate, and as a polishing step for certain waste types. This treatment module is employed in food processing industries, paper and pulp mills, textile mills, refineries, and petrochemical plants.

(2) Advantages/disadvantages. The advantages and disadvantages of stabilization ponds and aerated lagoons are as follows:

Advantages	Disadvantages
Operating costs are low compared with other biological treatment methods	Tolerate low-strength wastes only
Cost-effective treatment for polishing effluent	Intolerant of suspended solids and metals
Waste stabilization ponds require minimal energy	Require large land areas
	Performance markedly affected by temperature, and treatment method is not suitable for freezing temperatures

(Continued)

Advantages

Disadvantages

System has limited flexibility

Volatile gases may be emitted from processes

(3) Data requirements. The data requirements are generally the same as those for activated sludge systems. The nonbiodegradable fraction and average MLVSS are not required; however, the summer and winter ambient conditions will affect performance.

(4) Design criteria.

(a) Each subtype of waste stabilization pond utilizes a different type of bacteria but is of similar construction, with an earthen pit and earthen side levees. Treatment of leachates requires that the pond be lined. The designs of various waste stabilization ponds and anaerobic lagoons differ significantly. Table 4-4 summarizes the major design criteria. The criteria indicate that, in general, lagoons can treat only low-strength waste and therefore will be best suited as a polishing step used in conjunction with other treatment methods.

(b) As Table 4-4 indicates, the aerobic lagoon requires the greatest surface area to treat an equivalent waste load. Oxygen transfer depends on the ratio of lagoon surface area to volume (length-to-width ratio should be less than 3:1), temperature, turbulence, and bacterial oxygen uptake. The system has the least tolerance for high organic loads but benefits from a short detention time. Anaerobic stabilization ponds require significantly less surface area and can handle substantially higher organic loads. Deep lagoons benefit from better heat retention, and an effluent length-to-width ratio of 2:1 is recommended.

(c) Sludge buildup is much less for the anaerobic pond than that for the aerobic; for every Kg (pound) of BOD destroyed by the anaerobic process, about 0.1 Kg (pound) of solids is formed, as compared to 0.5 Kg (pound) for the aerobic lagoon. The major disadvantage of the anaerobic lagoon is that it produces strong odors unless the sulfate concentration is maintained below 100 milligrams per liter.

(d) The facultative lagoon benefits from having an aerobic layer that oxidizes hydrogen sulfide gas to eliminate odors. It can handle BOD loads intermittently between the anaerobic and aerobic lagoon.

(e) Artificial aeration with mechanical or diffused aerators allows for deeper basins and higher organic loads than those obtained in aerobic lagoons. The basins are designed for partial mixing only, and anaerobic decomposition occurs on the bottom. Operating costs are significantly less than those for activated sludge, but the system cannot withstand the organic loads tolerated by activated sludge. In general, the use of several lagoons in series is more

Table 4-4. Design Criteria for Waste Stabilization Ponds¹

<u>Design parameter</u>	<u>Aerobic</u>	<u>Facultative</u>	<u>Anaerobic</u>	<u>Aerated</u>
Depth, m (ft)	0.27 to 0.55 (0.9 to 1.8)	0.55 to 1.4 (1.8 to 4.5)	2.3 to 5.5 (7.5 to 18)	9.1 to 5.5 (3 to 18)
Organic load, kg/ha/day (lb BOD/acre/day)	100 to 200 (89.3 to 178.6)	10 to 100 (8.93 to 89.3)	200 to 2000 (178.6 to 1786)	10 to 31 (8.93 to 267.9)
Detention time typical, days	2 to 6	7 to 30	30 to 50	3 to 10
Influent BOD, mg/l	200	200 to 500	500 and up	200 to 500
Flow regime	Intermittently mixed	Mixed surface layer	Not mixed	Completely mixed
Principal conver- sion product	Algae, CO ₂ , bacteria	Algae, CO ₂ , CH ₄ , bacteria	CO ₂ , CH ₄ , bacteria	CO ₂ , bacteria
Algal concen- tration, mg/l	40 to 100	10 to 80	0 to 5	--
Operating pH	6.5 to 10.5	6.5 to 9.0	6.8 to 7.2	6.5 to 8.0
Effluent suspended solids, mg/l	10 to 140	40 to 100	80 to 160	80 to 250

¹ Adapted from EPA (1979), Liptak (1974), and Metcalf and Eddy, Inc. (1979).

efficient than one lagoon since it can reduce short-circuiting and lead to increased organic removal efficiency.

4-6. Carbon Adsorption.

a. Process Description.

(1) Activated carbon, granular or powdered, when contacted with water containing organic material, will remove these compounds selectively by a combination of adsorption of the less polar molecules, filtration of the larger particles, and partial deposition of colloidal material on the exterior surface of the activated carbon. Adsorption results from the forces of attraction between the surface of a particle and the soluble organic materials that contact the particle. As a result of the activation process, activated carbon has a large surface area per unit weight, making it a very efficient adsorptive material. It has long been used to remove taste and odor-causing impurities from public water supplies. More recently, activated carbon adsorption has been used in waste-water treatment as a tertiary process following conventional secondary treatment or as one of several unit processes comprising physical-chemical treatment. Pesticides and other long-chain organics have excellent adsorption characteristics on activated carbon.

(2) The most efficient and practical use of activated carbon in waste-water treatment has been in fixed beds of granular activated carbon. A typical adsorption system consists of several adsorption trains operated in parallel. Each train contains two adsorbers arranged for series flow. The waste water is applied to the adsorbers at a flow rate ranging from 1.6×10^{-2} to 3.3×10^{-2} m³/min/m² (4 to 8 gallons per minute per square foot). Contact time (empty bed residence time) ranges from 15 to 35 minutes depending on the desired effluent quality. Countercurrent flow systems allow systems to approach activated carbon isotherm capacity and are recommended.

(3) To minimize suspended solids collection which can clog the pores and reduce adsorber capacity, the carbon adsorption system should be preceded by media filtration. Provisions must be made to regularly backwash the adsorption system to flush out accumulated suspended solids and biological growth. A good design practice is to allow for a bed expansion of up to 50 percent. Flow rates during backwash should range from 6.2×10^{-2} to 8.2×10^{-2} m³/min/m² (15 to 20 gallons per minute per square foot). Biological growth can be controlled effectively by chlorination of the influent to the adsorber or by chlorination during the backwash operation.

(4) When the active sites on the carbon particles have been filled, the effluent quality deteriorates and the carbon must be regenerated or replaced. It is not economical to have onsite regeneration for systems requiring regeneration of less than about 91 kg (200 pounds) of carbon per day. For larger systems, a regeneration system should be provided. A typical regeneration system includes: (a) hydraulic transport of the carbon to the regeneration unit, (b) dewatering of spent carbon, (c) heating of carbon to oxidize or volatilize the adsorbed impurities, (d) water cooling of the carbon, (e) water washing and hydraulic transport back to the adsorbers, and (f) scrubbing of

furnace off-gasses. The most common type of furnace in use is the multiple hearth furnace.

(5) Input such as the minimum contact time, optimum flow rate, head loss at various flows, backwash rate, and required carbon dosage should be obtained from onsite pilot plant carbon column tests. Where this is not possible, accepted design criteria should be used to generate the required input data. Static isotherm tests conducted in the laboratory are not sufficient.

b. Applications.

(1) The suitability of carbon adsorption for treatment of waste water associated with disposal sites depends upon the influent characteristics, the extent of pretreatment, and the required effluent quality. The highest concentration of solute in the influent stream that has been treated on a continuous basis is 10,000 mg/l (10,000 ppm TOC), and a 1 percent solution is currently considered as the upper limit.

(2) Concentrations of oil and grease in the influent should be limited to 10 mg/l (10 ppm). Concentrations of suspended solids should be less than 50 mg/l (50 ppm) in upflow systems; downflow systems can handle concentrations as high as 2,000 mg/l (2,000 ppm), although frequent backwashing would be required. Removal of inorganics by carbon generally requires concentrations of less than 1,000 mg/l (1,000 ppm) and preferably less than 500 mg/l (500 ppm).

(3) The suitability of using activated carbon for removal of a specific solute depends upon its molecular weight, structure, and solubility. Table 4-5 summarizes the influence of molecular structure and other properties of organics on their adsorbability. Table 4-6 summarizes the potential for removal of inorganics by activated carbon.

(4) As would be expected from the information in Table 4-5, activated carbon has been proven effective in the removal of a variety of chlorinated hydrocarbons, organic phosphorus, carbonates, PCBs, phenols, and benzenes. Specific hazardous organics that are effectively removed include aldrin, dieldrin, endrin, DDD, DDE, DDT, toxaphene, and two aroclors. A granular activated carbon system was used as part of the treatment system for the Bridgeport, New Jersey, remedial action. Mobile carbon systems have also been used successfully for several years.

(5) Activated carbon treatment has not been shown to be suitable for treatment of municipal landfill leachates from young landfills; carbon shows poor adsorption capacity for fatty acids, which are prevalent in municipal landfill leachate. Carbon adsorption is generally not effective for wastes with high BOD/COD and COD/TOC ratios.

c. Advantages/disadvantages. The advantages and disadvantages of carbon absorption are summarized below:

Table 4-5. Effects of Molecular Structures and Other Factors on Adsorption by Activated Carbon

-
1. Aromatic compounds are generally more adsorbable than aliphatic compounds of similar molecular size.
 2. Branched chains are usually more adsorbable than straight chains.
 3. Substituent groups affect adsorbability:

<u>Substituent group</u>	<u>Nature of influence</u>
Hydroxyl	Generally reduces adsorbability; extent of decrease depends on structure of host molecule
Amino	Effect similar to that of hydroxyl but somewhat greater. Many amino acids are not adsorbed to any appreciable extent
Carbonyl	Effect varies according to host molecule; glyoxylic and more adsorbable than acetic but similar increase does not occur when introduced into higher fatty acids
Double bonds	Variable effect
Halogens	Variable effect
Sulfonic	Usually decreases adsorbability
Nitro	Often increases adsorbability

4. An increasing solubility of the solute in the liquid carrier decreases its adsorbability.
 5. Generally, strongly ionized solutes are not as adsorbable as weakly ionized ones; i.e., undissociated molecules are, in general, preferentially adsorbed.
 6. The amount of hydrolytic adsorption depends on the ability of the hydrolysis to form an adsorbable acid or base.
 7. Unless the screening action of the carbon pores intervenes, large molecules are more sorbable than small molecules of similar chemical nature. This is attributed to more solute carbon chemical bonds being formed, making desorption more difficult.
-

Table 4-6. Potential for Removal of Inorganic Material
by Activated Carbon

<u>Constituents</u>	<u>Potential for removal by carbon</u>
<u>Metals of high sorption potential</u>	
Antimony	Highly sorbable in some solutions
Arsenic	Good in higher oxidation states
Bismuth	Very good
Chromium	Good, easily reduced
Tin	Proven very high
<u>Metals of good sorption potential</u>	
Silver	Reduced on carbon surface
Mercury	CH ₃ HgCl sorbs easily, metals filter out
Cobalt	Trace quantities readily sorbed, possibly as complex ions
Zirconium	Good at low pH
<u>Elements of fair-to-good sorption potential</u>	
Lead	Good
Nickel	Fair
Titanium	Good
Vanadium	Variable
Iron	Fe ³⁺ good, Fe ²⁺ poor, but may oxidize
<u>Elements of low or unknown sorption potential</u>	
Copper	Slight, possibly good if complexed
Cadmium	Slight
Zinc	Slight
Beryllium	Unknown
Barium	Very low
Selenium	Slight
Molybdenum	Slight at pH 6-8, good as complex ion
Manganese	Not likely, except as MnO
Tungsten	Slight
<u>Miscellaneous inorganic water constituents</u>	
Phosphorus	
P, free element	Not likely to exist in reduced form in water
PO ₄ ³⁻ phosphate	Not sorbed but carbon may induce precipitation Ca ₃ (PO ₄) ₂

(Continued)

Table 4-6. (Continued)

<u>Constituents</u>	<u>Potential for removal by carbon</u>
<u>Free halogens</u>	
F ₂ fluorine	Will not exist in water
Cl ₂ chlorine	Sorbed well and reduced
Br ₂ bromine	Sorbed strongly and reduced
I ₂ iodine	Sorbed very strongly, stable
<u>Halides</u>	
F ⁻ Fluoride	May sorb under special conditions
Cl ⁻ , Br ⁻ , I ⁻	Not appreciably sorbed

<u>Advantages</u>	<u>Disadvantages</u>
High flexibility in operation and design	Intolerant of high suspended solids levels
Suitable for treatment of a wide range of organics that do not respond to biological treatment	Carbon can be "poisoned" by high heavy metals concentrations which will affect organic adsorption
Has high adsorption potential for some highly hazardous inorganics (e.g., Cr, Cn)	Requires pretreatment for oil and grease removal where concentrations are greater than 10 mg/l (10 ppm)
Tolerant of some fluctuations in concentrations and flow	Not suitable for removal of low molecular weight organics, highly soluble or highly ionized organics
	Limited to wastes with less than 10,000 mg/l (10,000 ppm) organics
	O&M costs are high

d. Data requirements. Data requirements are as follows:

- (1) The waste stream average daily flow.
- (2) The waste stream contaminant concentrations.
- (3) Carbon physical properties (bulk density) and the amount lost during one regeneration cycle (if regeneration is included in design).
- (4) Hydraulic loading rate (usually 8.2×10^{-3} to 3.3×10^{-2} m³/min/m² (2 to 8 gallons per minute per square foot)).

(5) Organic removal rate, adsorption efficiency, and adsorption rate constant.

(6) The backwash hydraulic loading (if backwashing is included in design).

e. Design criteria.

(1) Critical design criteria are organic load, hydraulic load, contacting method, contact time, and regeneration requirements. The approximate carbon requirements for a specific organic load, and the residual organic levels can be roughly estimated from adsorption removal kinetics conducted on a batch basis. An isotherm can be used as a functional expression for variation of adsorption with concentration of adsorbate in bulk solution. The Freundlich isotherm is expressed in terms of removal of impurity (i.e., BOD, COD, or color).

$$\frac{X}{M} = KC^{1/n} \quad (4-4)$$

where

X = impurity adsorbed

M = weight of carbon

C = equilibrium concentration of impurity

K,n = constant (Culp et al. 1978)

(2) Isotherms are a useful approximation of treatability, but generally give a falsely high estimate of continuous carbon performance. A continuous-flow pilot carbon treatment system is generally a prerequisite of design except on an emergency basis.

(3) There are four basic ways that waste streams can be contacted, and the choice of the appropriate method depends upon influent characteristics, effluent criteria, flow rate, and economics. Table 4-7 summarizes these available methods, and Figure 4-8 illustrates them. Figure 4-9 illustrates a process flow diagram with upflow carbon contactors and regeneration. Typical operating parameters for carbon adsorption systems are summarized in Table 4-8. The parameters are based on system operations for physical/chemical and tertiary treatment systems.

(4) The decision to regenerate and reuse granular carbon or to use it on a once-through basis is made primarily on economics. Toxicity of the absorbed chemicals can also affect this decision; however, for plants requiring less than 91 kg (200 pounds) per day of carbon (less than approximately 3032 m³/day (0.8 million gallons per day)), regeneration is probably not

Table 4-7. Summary of Activated Carbon Contacting Methods

Method	Comments
Downflow adsorbers in parallel	<p>For high volume applications Can handle higher than average suspended solids (65-70 mg/ℓ (~65-70 ppm)) Relatively low capital costs Effluents from several columns blended, therefore less suitable where effluent limitations are low 8.2×10^{-3}-4.1×10^{-2} m³/min/m² (2-10 gpm/ft²) flow rate</p>
Downflow adsorbers in series	<p>Large volume systems Countercurrent carbon use Effluent concentrations relatively low Can handle higher than average suspended solids (65-70 mg/ℓ (~65-70 ppm)) if downflow Capital costs higher than for parallel systems 8.2×10^{-3}-4.1×10^{-2} m³/min/m² (2-10 gpm/ft²)</p>
Moving bed	<p>Countercurrent carbon use (most efficient use of carbon) Suspended solids must be low (10 mg/ℓ (<10 ppm)) Capital and operating costs relatively high Can use such beds in parallel or series 4.1×10^{-3}-2.9×10^{-2} m³/min/m² (1-7 gpm/ft²) flow rate</p>
Upflow-expanded series	<p>Countercurrent carbon use (if in series) Can handle high suspended solids (they are allowed to pass through) High flows in bed (6.2×10^{-2} m³/min/in²-15 gpm/ft²) Minimum pretreatment Minimum headloss</p>

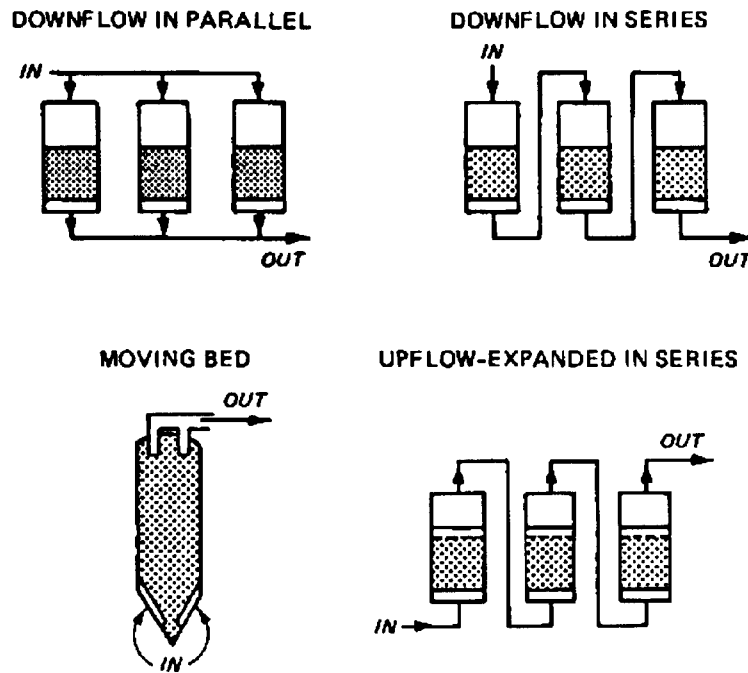

Figure 4-8. Most Common Configuration of Activated Carbon Adsorber Systems

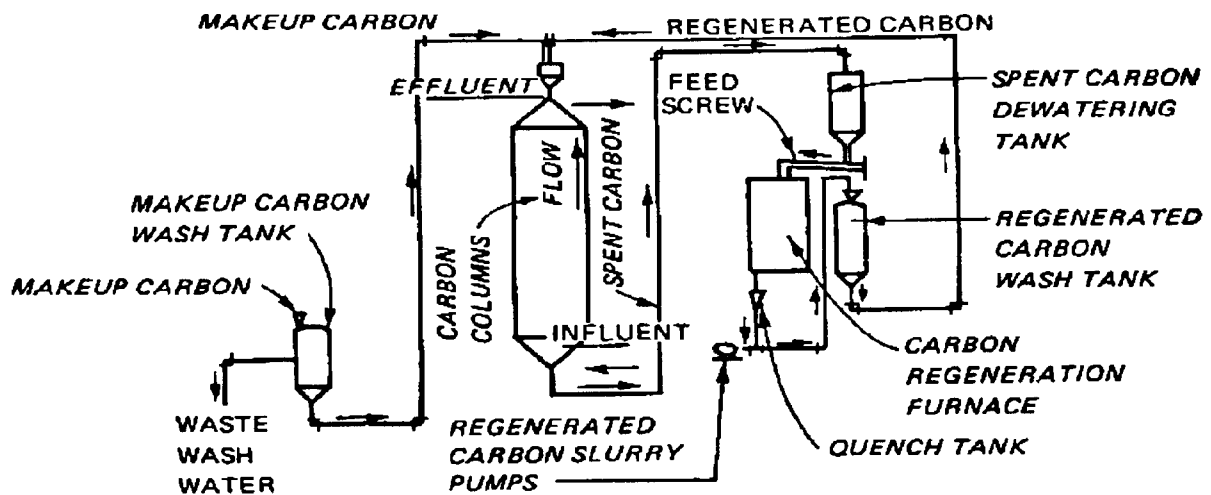

Figure 4-9. Process Flow Diagram with Upflow Carbon Contactors and Regeneration

Table 4-8. Operating Parameters for Carbon Adsorption

Parameter	Requirements
Contact time	Generally 10-50 min; may be as high as 2 hr for some industrial wastes
Hydraulic load	8.2×10^{-3} - 6.2×10^{-2} m ³ /min/m ² (2-15 gpm/ft ²) depending on type of contact system, see Table 4-7
Backwash rate	Rates of 8.2×10^{-3} - 4.1×10^{-2} m ³ /min/m ² (920-30 gpm/ft ²) usually produce 25-50 percent bed expansion
Carbon loss during regeneration	4-9 percent 2-10 percent
Weight of COD removed per weight of carbon	0.2-0.8
Carbon requirements	
PCT plant	60-216 mg/l (500-1,800 lb/10 ⁶ gal)
Tertiary plant	24-60 mg/l (200-500 lb/10 ⁶ gal)
Bed depth	3-9.1 m (10-30 ft)

economical. Most leachate and ground-water treatment facilities will fall within this range. Use of electric furnaces, rather than multiple-hearth furnaces, may make it possible to regenerate activated carbon economically for plants using less than 200 pounds per day. Regeneration needs can be determined on the basis of COD adsorbed per pound of carbon or required carbon dosage in terms of total flow.

4-7. Chemical Oxidation.

a. Process Description.

(1) Oxidation reactions are among the most important chemical reactions with which the engineer deals. They are involved in a wide range of laboratory analyses as well as water and waste-water treatment. No oxidation reaction occurs without a concomitant reduction reaction and vice versa.

(2) Chemical oxidation is a process in which the oxidation state of a substance is increased. Conversely, chemical reduction is a process in which the oxidation state is reduced.

(3) Even though redox reactions are applicable to metals and nonmetals, organics and inorganics, the discussion here will be directed largely to

organics and nonmetals. Applications of oxidation are at present largely limited to potable water treatment, specialized industrial water and waste-water treatment, and high-level tertiary waste treatment.

(4) Due to the costs involved, oxidation reactions are usually carried out only for pretreatment or post-treatment. For pretreatment, the objective is usually to remove specific compounds or groups, cleave organic molecule chains, and/or detoxify such as to make the waste suitable for biological treatment. Post-treatment operations are usually carried out to remove residual BOD to meet stringent effluent requirements.

(5) Oxidizers most often used in waste-water treatment include the following:

- (a) Oxygen or air (21 percent oxygen).
- (b) Ozone.
- (c) Chlorine and hypochlorites.
- (d) Chlorine dioxide.
- (e) Hydrogen peroxide.
- (f) Potassium permanganate.

(6) Oxygen-molecular oxygen is a weak oxidizing agent when compared to others mentioned. It is mentioned here primarily due to its attractive cost. The use of molecular oxygen may be limited to the oxidations of certain metals such as iron and manganese. However, it is sometimes reported to remove BOD by chemical oxidation. These reductions are probably the result of a stripping action as opposed to actual oxidation. Air sparging would be expected to remove volatile gases such as carbon dioxide, hydrogen sulfide, methane, and certain other low-boiling organic compounds.

(7) Ozone is a powerful oxidizing agent, as illustrated by the following redox potentials:

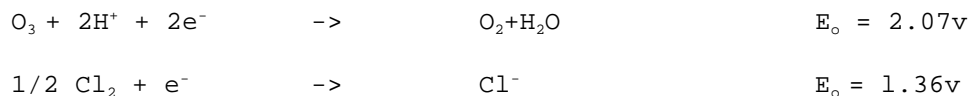

It is sufficiently strong to break many carbon-carbon bonds and even to cleave aromatic ring systems, e.g., conversion of phenol to three molecules of oxalic acid. Complete oxidation of some organic species to CO₂ and H₂O can be expected if ozone dosage is sufficiently high. However, some materials show almost complete resistance to ozone attack. A Refractory Index (RFI) has been defined so as to provide pertinent information on the relative reactivity of ozone with a variety of materials. The RFI is defined as the pounds of ozone per pound of contaminant that would be required to bring about 50 percent conversion of oxidation in one hour. RFI values for a cross-section of compounds are shown in Table 4-9. Several compounds are resistant to ozone,

Table 4-9. Resistance of Selected Species to Ozone Oxidation

Compound	O_3^1	UV/O_3^2
KCN	0.41	-
Color (units)	0.66	-
Complexed Cd- cyanide	0.96	-
Phenol	4.4	-
Ammonium ion	8	-
Glycine	19.7	6.0
Ammonium palmitate	27.3	7.2
Glycerol	112	7.4
Ethanol	245	41.0
Complexed ferricyanide	270	8.6
Acetic acid	1,000	47.0

¹Pounds of ozone per pound of contaminant required for 50 percent conversion.

²Pounds of ozone per pound of contaminant with addition of ultraviolet light required for 50 percent conversion.

acetic acid for example. Carboxylic acids, in general, are resistant to chemical oxidation. Typical treatment efficiencies are listed in Table 4-10.

(a) Typically, oxidation reactions will not be carried out to completion due to physical restraints on the ozone-contaminant system and due to economics involved. Since only partial oxidations will occur, it is important to know the types of end products remaining. Some examples are given in Table 4-11.

(b) Ozone is not stable in either the gaseous form or in solution. Decomposition in the gas phase generally increases with temperature and is catalyzed by solid alkalis, metals, metal oxides, carbon, and moisture.

(c) Many redox reactions are pH dependent. However, ozone is an exception and is relatively insensitive to pH. One exception is that of converting cyanide to carbon dioxide. This reaction requires a pH of about 9 before ozonation.

(d) Ultraviolet light has been shown to provide a powerful synergistic action with ozone. The result of this phenomenon is also shown in Table 4-9. Compounds that showed essentially no reactivity with ozone showed at least partial degradation with the addition of ultraviolet light. Ultraviolet light can also generate ozone from oxygen in the air.

Table 4-10. COD Reduction by Ozone

Compound	Concentration (g/l)	Volume treated (liters)	O ₃ (g/hr)	%COD reduction for given hours of treatment time							
				2	3	6	8	12	16	24	
Acetic acid	1	3	2.45	0	0	0	0	0	0	0	0
Benzyl alcohol	1	1	0.5	10	26	--	58	--	--	--	--
Diethylene glycol	1	3	1.47	18	27	27	30	30	30	30	30
Ethylene diamine	1	1	0.5	7	26	--	33	--	--	--	--
Ethylene glycol	1	1	0.5	9	17	--	31	--	--	--	35
Formalin	5.0	3	2.28	10	20	29	36	44	48	53	53
Glycine	1.0	3	1.0	10	0	0	0	0	0	0	0
Hydroquinone	1	1	0.5	25	46	--	--	--	--	--	--
Hydroxylamine sulfate	1	3	1.88	41	58	67	72	77	78	--	--
Maleic acid	(not given)	3	2.44	62	73	79	83	89	92	95	95
Menthol	1	3	2.12	8	13	17	21	27	31	37	37
Potassium ferricyanide	11.0	2	4.0	1	2	3	4	6	7	11	11
Sodium formate	2.0	3	1.4	42	63	75	83	93	98	--	--
Sodium thiocyanate	1	1	0.5	88	90	90	--	--	--	--	--
Sodium thiosulfate	1	1	0.5	94	97	--	--	--	--	--	--

Table 4-11. Products of Ozonation of Various Compounds

<u>Species</u>	<u>Ozonation product</u>	<u>Comments</u>
Chromium (III) Cr^{+3}	Chromium (VI) CrO_3	
Cyanide CN^- (free)	Cyanate CNO^-	Cyanate can be further degraded to CO_2
Ferrocyanide $Fe(CN)_6^{-4}$	Ferricyanide $Fe(CN)_6^{-3}$	Used in regeneration of photo bleach
Ammonia NH_3	Nitrate NO_3^-	Fairly slow
Dimethyl sulfide CH_3SCH_3	Dimethyl sulfoxide CH_3SCH_3	Reduces or eliminates odor problems
Amine $(CH_3CH_2CH_2CH_2)_3N$	Amine oxide $(CH_3CH_2CH_2CH_2)_3NO$	
Alcohol CH_3OH	Aldehyde CH_2O	
Aldehyde CH_2O	Carboxylic acid $HCOOH$	Evidence for stepwise oxidation is clear
Carboxylic acid CH_3COOH	No reaction	
Phenol $C_6H_5 OH$	Oxalic acid $COOH$ $COOH$	By way of quinone and intermediate, unsaturated acids
Alkene $\begin{array}{c} R & & R \\ & \diagdown & / \\ & C = C & \\ & / & \diagdown \\ R & & R \end{array}$	Aldehydes, ketones, carboxylic acids $R_2C = O$ $RCOOH$ $RHC = O$	

(8) Hydrogen peroxide.

(a) Hydrogen peroxide is a moderate strength chemical oxidant compared to chlorine. It does not produce chlorinated oxidation products species, however, and may be preferable to chlorine in many instances. Its lower oxidizing potential can result in selective reactions to oxidize a specific pollutant (e.g., H₂S) without oxidizing a wide spectrum of other organic and inorganic compounds also present in the mixture. Consumption of hydrogen peroxide can be significantly less than many other common oxidants. In dilute solution (<30 percent), the decomposition of hydrogen peroxide is accelerated by the presence of metal ion contaminants. Industrial strength hydrogen peroxide (>30 percent) can catalyze these contaminants in violent decomposition.

(b) Hydrogen peroxide can oxidize many chemicals present in contaminated ground water and leachates. Examples of these chemicals are: hydrogen sulfide and mercaptans, phenol in liquid or gas, ferrous iron, photo waste-silver, thiosulfate, cyanide, and hypochlorite (chlorine residual). Mercaptans and sulfides are usually the cause of odor complaints, may be toxic, and can result in corrosion of metals and concrete. Hydrogen peroxide can detoxify specific compounds by organic ring cleavage, stripping substituent groups, or oxidizing specific items such as sulfur. Treatment may also improve the biodegradability of wastes.

(c) A summary of the primary oxidants used in waste-water treatment and their identified applications is presented in Table 4-12.

b. Advantages/Disadvantages. Advantages and disadvantages of chemical oxidation are shown below:

<u>Advantages</u>	<u>Disadvantages</u>
Effective on dilute waste streams	Higher treatment costs than comparable biological treatment systems
Can be used to detoxify and improve biodegradability and adsorption characteristics	Some organics are resistant to most oxidants
	Inorganics such as chloride will interfere with the oxidation reaction
	Partial oxidation may generate toxic compounds

c. Data Requirements. Data requirements for the chemical oxidation process will depend upon the objective of the treatment and the oxidation potential and reactivity of the waste. In general, the necessary data can only be determined by bench or pilot scale testing. Typical data needs are listed below:

Table 4-12. Waste Treatment Applications for Selected Oxidants

Oxidant	Waste
Oxygen or air	Sulfites (SO_3^-) Sulfides (S^-) Ferrous iron (Fe^{++}) very slow Manganese (Mn^{++}) Carbon dioxide (CO_2) Methane (CH_4)
Ozone	Cyanides (CN^-) Color OH Phenol Ammonia (NH_3) fairly slow Chromium (Cr^{+3}) Amines Alcohols Aldehydes Alkenes
Chlorine and hypochlorites	Sulfides (S^-) Mercaptans Cyanide (CN^-) Lead (Pb) Nitrite (NO_2^-) Manganese (Mn^{++}) Ferrous iron (Fe^{++})
Chloride dioxide	Cyanide (CN^-) Diquat pesticides Paraquat Sulfide (S^-) Aldehydes Amines (tertiary) Mercaptans Phenol
Hydrogen peroxide	Phenol Cyanide Sulfides Sulfites Lead Ferrous iron Sulfates Hypochlorite Mercaptans

- (1) Effectiveness of various oxidants for the specific waste to be oxidized.
- (2) Reaction time required and dosage of oxidant necessary to produce adequate destruction.
- (3) Optimum pH.
- (4) Interfering species in the waste.
- (5) Pretreatment requirements.
- (6) Resulting product toxicity.
- (7) Requirement for catalysts.
- (8) Light absorption characteristics in ultraviolet (UV) area.

d. Design Criteria.

(1) The UV-ozone chemical oxidation system shows promise for hazardous waste treatment due to its high reaction potential. UV-ozone will oxidize most organics, cleave carbon-carbon bonds, oxidize substituent groups, and open aromatic rings.

(2) There are several critical characteristics associated with the use of UV light. Short-wavelength UV light is required to provide sufficient energy to properly excite the molecule to be oxidized. Almost any medium through which the light passes will attenuate the light energy. The lamp and sleeves must be constructed from a special quartz to transmit the short wavelengths. The depth of the fluid being treated should be minimized. In order for the molecule to be excited and oxidized, it must be capable of absorbing light in the UV band.

(3) The surface of the quartz sleeves in contact with process fluid tends to become fouled. Some manufacturers provide a traveling rake to continuously clean these surfaces.

(4) A reaction time of 30 minutes to 1 hour is usually sufficient for most designs but this must be confirmed through pilot plant testing. Agitation increases effectiveness and should be provided where feasible.

(5) The dose of ozone or other chemical oxidant can be estimated by theoretical calculations sufficient for planning-level calculations. A 10 to 20 percent excess is recommended. Calculations must address all of the oxidizable materials in the waste.

4-8. Resin Adsorption.

a. Process Description.

(1) Resin adsorption is a process for the removal of organic chemicals from liquid waste streams. It is somewhat similar to adsorption on activated carbon. Perhaps the most significant difference between the two is that resins are always chemically regenerated through the use of caustic, steam, or organic solvents while carbon must be thermally regenerated because of the strong adsorptive forces. Synthetic resins generally have a lower adsorption capacity, a higher initial cost, and a longer operating life.

(2) Resin adsorption should be given serious consideration:

- (a) For the treatment of colored wastes; ROD and COD may be high.
- (b) When material recovery is practical.
- (c) Where selective adsorption is desired.
- (d) Where low leakage rates are required.
- (e) Where carbon regeneration is not practical.
- (f) Where there are high levels of dissolved inorganic solids.

(3) Process flow sheets vary depending on the nature of the solute and the regenerant used. Organic solvents such as acetone, methanol, and isopropanol have been used for regeneration purposes. The solvent overcomes the adsorbent resin's attractive forces which allows the adsorbed organic to diffuse into the solvent phase. A system used for the recovery of phenol using acetone as a regenerant is shown in Figure 4-10.

(4) Inorganic solvent systems used for regeneration purposes include steam, aqueous caustic solutions for removing adsorbed weak acids, and aqueous acids for removing adsorbed weak bases. A system used for the recovery of chlorinated hydrocarbon using steam as a regenerant is shown in Figure 4-11.

(5) Resin lifetimes may vary considerably depending on the nature of the feed and regenerant streams. Regeneration with caustic is estimated to cause a loss of 0.1 to 1 percent of the resin per cycle; replacement of resins at such installations may be necessary every 2 to 5 years. Regeneration with hot water, steam, or organic solvent should not affect the resins, and, in this case, lifetimes will be limited by slow fouling or oxidation resulting in a loss of capacity; actual experience indicates that lifetimes of more than 5 years are obtainable.

(6) Synthetic resins are available commercially from three manufacturers. A summary of the properties of some available resins is shown in Table 4-13. One of the more important physical properties is that of pore size. This factor may allow selective adsorption based upon molecular size.

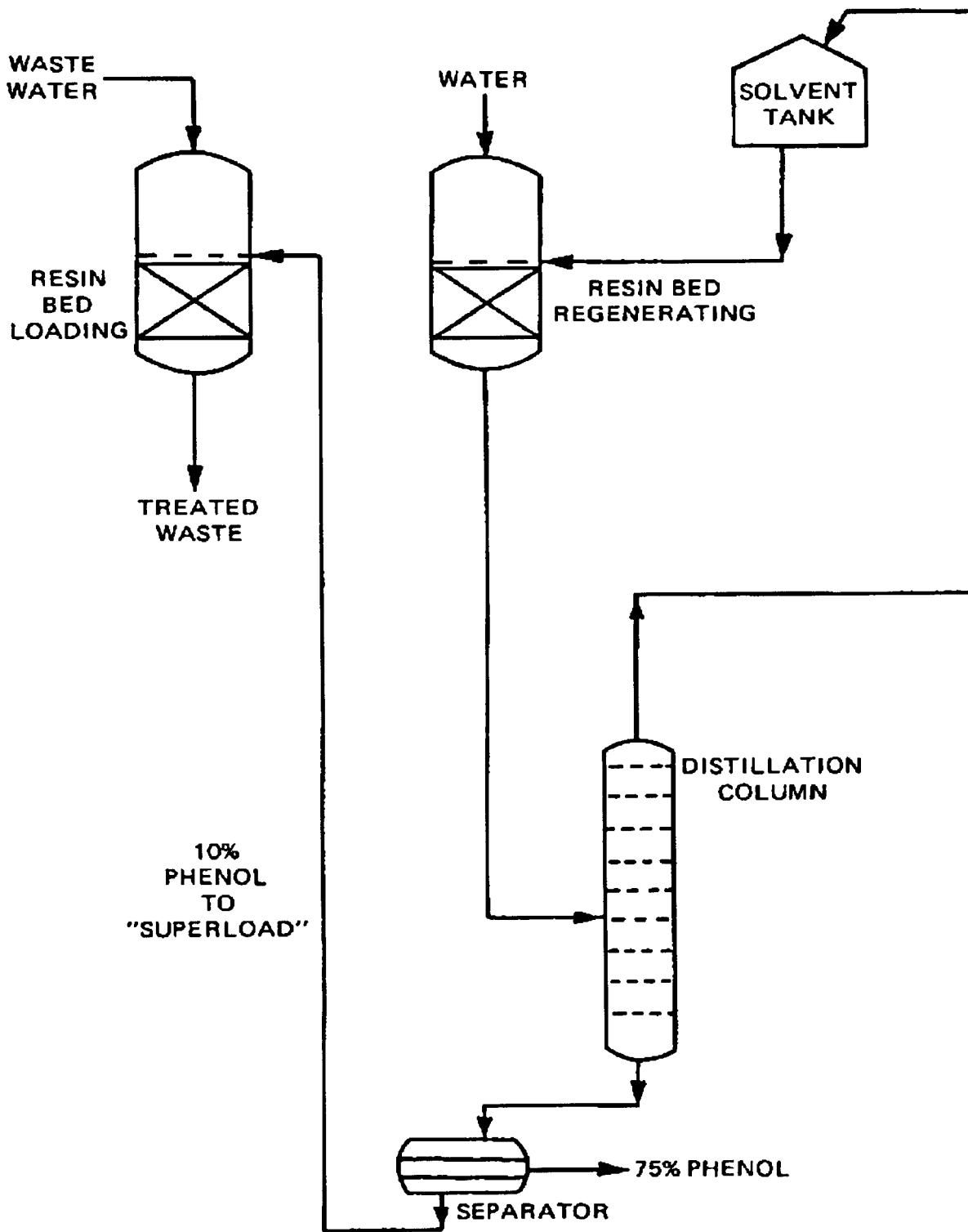

Figure 4-10. Phenol Recovery System Using Acetone Regenerant

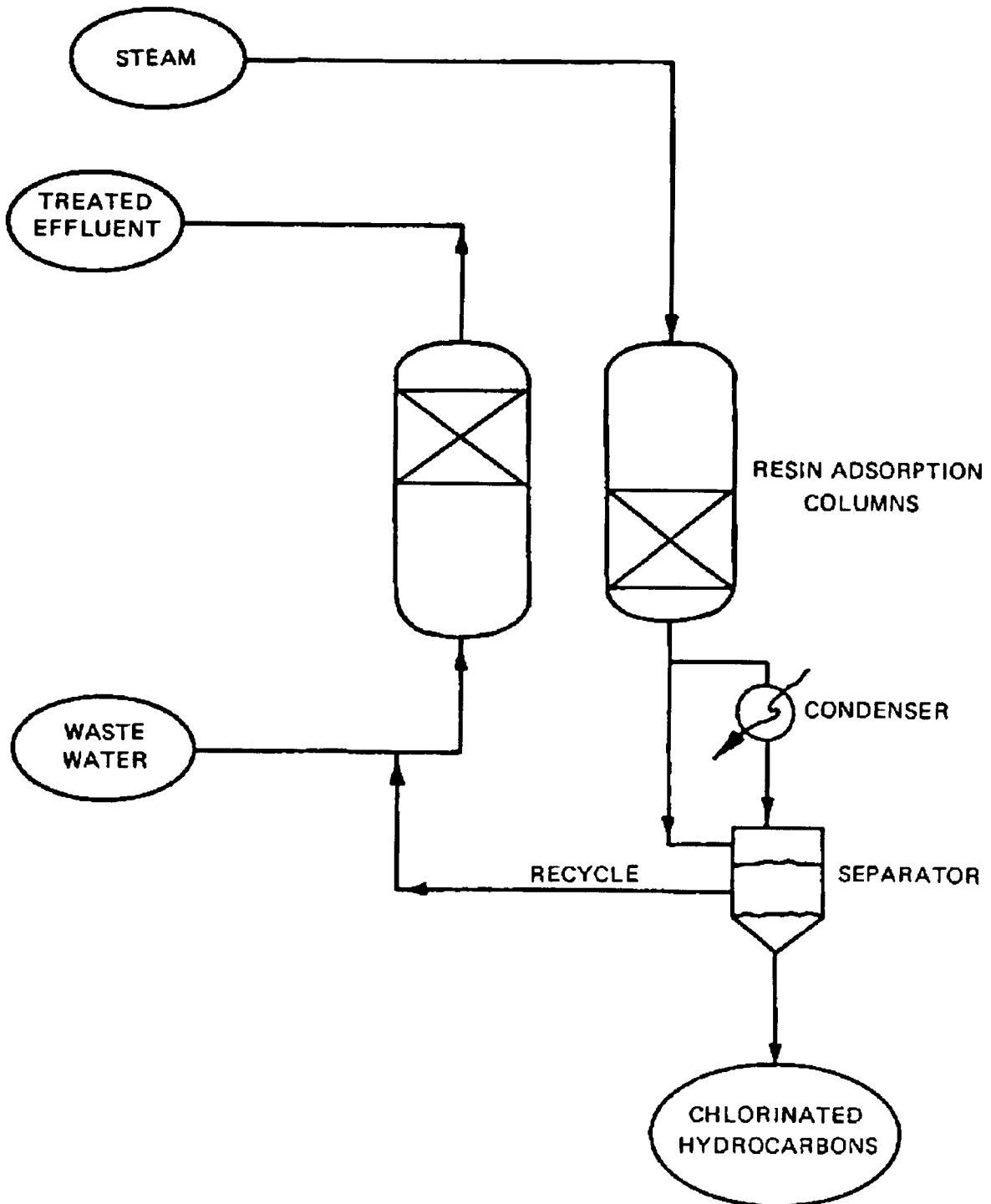

Figure 4-11. Chlorinated Hydrocarbon Recovery System Using Steam Regenerant

Table 4-13. Properties of Some Commercially Available Resin Absorbents

Resin Name ¹	Base	Specific gravity (wet)	Void volume %	Particle size mm	Bulk density kg/m ³ (pcf)	Surface Area	
						area m ² /g	Average pore size A°
XAD-1		1.02	37	20-50	--	100	200
XAD-2	Styrene-divinylbenzene	1.02	42	20-50	640-704 (40-44)	300	90
XAD-4		1.02	51	20-50	624 (39)	780	50
XAD-7		1.05	55	20-50	656 (41)	450	90
XAD-8	Acrylic ester	1.09	52	20-50	688 (43)	140	235
DOW XFS 4256 ²	Styrene-divinylbenzene	--	40	10+	432 (27)	400	110
DOW XFS 4022		--	35	20-50	--	100	200
DOW XFS 4257	--	--	40	20-50	--	400	100
Duolite S-30		1.11	35	16-50	480 (30)	128	--
Duolite S-37		1.12	35-40	16-50	640 (40)	--	--
Duolite ES-561	Phenol-formaldehyde ³	1.12	35-40	18-50	640-720 (40-45)	--	--
Duolite A-7D		--	--	--	--	--	--
Duolite A-7		1.12	35-40	16-50	640 (40)	--	--

¹ XAD resins manufactured by Rohm and Haas Company; DOW XFS manufactured by Dow Chemical USA; Duolite resins manufactured by Diamond Shamrock Chemical Company.

² This resin is designed for use in vapor phase adsorption applications.

³ Functional groups, such as phenolic hydroxyl groups and secondary and tertiary amines, are present on the basic phenol-formaldehyde structure. Physical form of these resins is granular as opposed to a bead for the other brands.

b. Applications.

(1) Polymeric adsorbent resins can be selected for specific applications. The surface area and pore structure can be controlled over a wide range of values. These factors are most important when the selective removal of a particular contaminant, perhaps hazardous, is desired. Also, when coupled with the weak attractive forces between solute molecules and resin product recovery may become a practical consideration. Even though overall capacities of synthetic resins may be less, capacity for a specific pollutant may be greater. This has been demonstrated for a number of pesticides.

(2) Polymeric adsorbents have been used to remove and recover a variety of toxic organic chemicals. These are as follows:

- ! Chlorinated pesticides.
- ! Phenols.
- ! Aliphatic chlorinated hydrocarbons.
- ! Aromatics (benzene, toluene, and xylene).

(3) Other reported uses include removal in dyestuff, removal of fat from meat packing operations, recovery of antibiotics, and removal of organics from brine.

c. Advantages/Disadvantages. Advantages and disadvantages of resin absorption are summarized below:

<u>Advantages</u>	<u>Disadvantages</u>
Resin can be designed for selective adsorption	Resin costs are higher than carbon
Leakage rates are much lower than for carbon	Resin cannot tolerate strong oxidizing agents
Regeneration is accomplished in situ with solvents	Usually have smaller system capacity than carbon
Resin can tolerate high levels of inorganic solvents	Pretreatment such as filtering is often necessary
Resin can operate over a wide pH range	Volume of solvent needed for backwash may be significant

d. Data Requirements

(1) Data requirements for resin adsorption will be much the same as those for carbon adsorption. Data concerning the resin itself are available from the manufacturers.

(2) As with carbon, isotherms must be available for the particular waste or contaminant under consideration. From isotherm data, capacity of the resin can be calculated. These data provide an estimate of the level of treatability that can be expected.

(3) Due to the fact that resin adsorption is relatively new and does not presently enjoy wide applications, pilot scale column studies are also recommended. These studies are used to confirm batch studies and provide information on optimum column height, flow rates, loadings, and potential operational problems.

(4) Unlike carbon adsorption, data must be generated to determine the regeneration of the resin and the ultimate disposal of solute removed. Regeneration can be accomplished using a variety of materials including caustic, hot water, steam, and organic solvents. If organic solvents are used, a distillation step is typically included.

e. Design Criteria. As a result of limited applications, design criteria for resin adsorption are not well defined. However, some suggestions are given below:

(1) Column should be operated in the downflow mode.

(2) Suspended solids in the influent should be maintained less than 10 milligrams per liter. (A sand filter may be required to pretreat the influent.)

(3) pH may be varied between 2 and 11 depending upon adsorption characteristics.

(4) Operating temperature may be as high as 80°C but will reduce capacity of resin.

(5) High total dissolved solids (TDS) in the influent do not detract from normal operations.

(6) Influent concentration of organics (C_0) should be limited as follows:

$$C_0 < (0.1) \frac{\text{capacity of resin}}{3 \times \text{bed volume}}$$

(7) Strong oxidants will attack the resin and must be removed.

(8) A minimum of two columns in parallel should be used; i.e., one on line and one regenerating.

(9) Flow rates through the bed should be 3.3×10^{-2} to $0.27 \text{ m}^3/\text{min}/\text{m}^3$ (0.25 to 2 gallons per minute per cubic foot) of resin or 2 to 16 bed volumes per hour.

(10) Contact times are on the order of 3 to 30 minutes.

4-9. Chemical Reduction.

a. Process Description.

(1) Chemical reduction is of interest because heavy metals in solution can often be reduced to their elemental form for potential recycling or can be converted to less toxic oxidation states. One such metal is chromium (Cr), which, when present as chromium (VI), is a very toxic material. In the reduced state, chromium (III), the hazards are lessened and in this form can be precipitated for removal. At present, chemical reduction is applied primarily to the control of hexavalent chromium in the plating and tanning industries and to the removal of mercury from caustic/chlorine electrolysis cell effluents.

(2) Reduction-oxidation, or redox, reactions are those in which the oxidation state of at least one reactant is raised while that of another is lowered. In the reaction

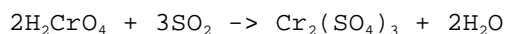

the oxidation state of Cr changes from 6⁺ to 3⁺ (Cr is reduced); the oxidation state of sulfur (S) increases from 2⁺ to 3⁺ (S is oxidized). This change of oxidation state implies that an electron was transferred from S to Cr(VI). The decrease in the positive valence (or increase in the negative valence) with reduction takes place simultaneously with oxidation in chemically equivalent ratios. Reduction is used to treat wastes in such a way that the reducing agent lowers the oxidation state of a substance in order to reduce its toxicity, reduce its solubility, or transform it into a form that can be more easily handled.

(3) The base metals are good reducing agents. Iron, aluminum, zinc, and sodium compounds are often used for the reduction treatments. In addition, sulfur compounds are also some of the more common reducing agents.

(4) Table 4-14 lists the more common reduction reactions for chromium (VI) treatment and their reaction products.

(5) The first step of the chemical reduction process is usually the adjustment of the pH of the solution to be treated. With sulfur dioxide treatment of chromium (VI), for instance, the reaction requires a pH in the range of 2 to 3. The pH adjustment is done with the appropriate acid (sulfuric, for example). This is followed by the addition of the reducing agent. Mixing is provided to improve contact between the reducing agent and the waste. The agent can be in the form of a gas (sulfur dioxide) or as a solution (sodium borohydride) or perhaps as a finely divided powder if there is adequate mixing. Reaction times vary for different wastes, reducing agents, temperatures, pH, and concentration. For commercial-scale operations

Table 4-14. Conventional Chrome Reduction Reactions

(1) Cr⁺⁶ to Cr⁺³ using sulfur dioxide

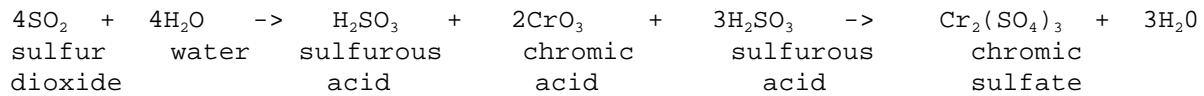

(2) Cr⁺⁶ to Cr⁺³ using bisulfites

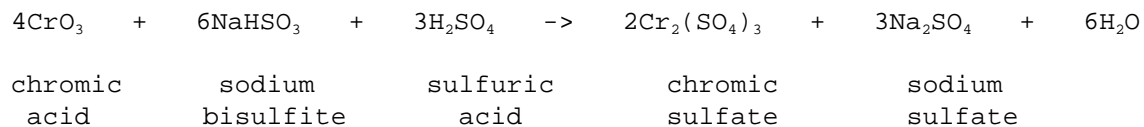

(3) Cr⁺⁶ to Cr⁺³ using ferrous sulfate

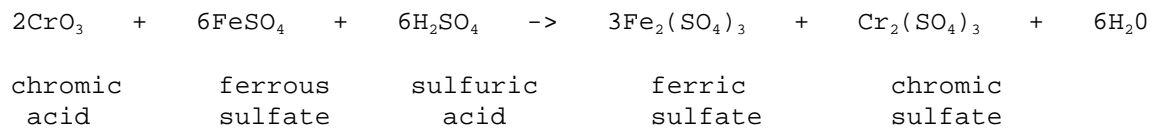

for treating chromium wastes, reaction times are on the order of minutes. Additional time is usually allowed to ensure complete mixing and reduction. Once reacted, the reduced solution is then generally subjected to some form of treatment to settle or precipitate the reduced material. A treatment for the removal of what remains of the reducing agent may be included. This can be unused reducing agent or the reducing agent in its oxidized state. Unused alkali metal hydrides are decomposed by the addition of a small quantity of acid. The pH of the reaction medium is typically increased so that the reduced material will precipitate out of solution. Filters or clarifiers are often used to improve separation.

b. Applications.

(1) The principal application of reduction has been chromium treatment and removal. Reduction reactions are typically pH dependent and will likely require pH adjustment.

(2) A second application of reduction is the removal of residuals of oxidants such as ozone, chlorine, chlorine dioxide, hydrogen peroxide, etc. Also, any off-gases from ozone generation and application require reduction before discharge to the atmosphere.

(3) Some specialized reduction reactions use hydrogen gas.

c. Advantages/Disadvantages. Advantages/disadvantages of reduction reactions are summarized below:

<u>Advantages</u>	<u>Disadvantages</u>
Reduction can reduce the toxicity of some material	Reduction reactions usually require pH adjustment as pretreatment
Reduction can provide favorable conditions for precipitation of some metals	Can cause the precipitation of some metals

d. Data Requirements. Typical data requirements are listed below:

- (1) Influent and peak flow rates.
- (2) Variability of influent volumes and concentrations.
- (3) pH conditions favorable to reduction reaction.
- (4) Concentrations of chemical species that require reduction.
- (5) Effectiveness of the reducing agent to effect the desired reaction.
- (6) Presence of interfering or competing chemicals in the waste.

e. Design Criteria.

(1) If wide fluctuations in flow and concentration are expected, equalization should precede this step.

(2) pH adjustment should be used as a pretreatment step to bring the solution to the desired pH.

(3) A stirred tank should be used to carry out the reduction. A chemical feed system is required to continuously charge the reducing agent. An oxidation reduction potential (ORP) control system may be used to control the quantity of reducing agent added.

(4) Detention time to accomplish chemical reduction will vary from 15 to 45 minutes and will be dictated by the particular reaction involved. Chromium reduction will require approximately 30 minutes but depends upon the pH and reducing agent used.

4-10. Precipitation.

a. Process Description.

(1) Precipitation is a widely used (in industrial practice), relatively low-cost physical chemical technique in which the chemical equilibrium of a waste is changed to reduce the solubility of the undesired components. These components precipitate out of solution as a solid phase, often in the form of small, colloidal particles, and are removed by one of

several possible solids removal techniques. Precipitation is most commonly used to treat heavy-metal-containing wastes.

(2) Precipitation can be induced by one of the following means:

(a) Adding a chemical that will react with the hazardous constituent in solution to form a sparingly soluble compound.

(b) Adding a chemical to cause a shift in solubility equilibrium, reducing the solubility of the hazardous substance.

(c) Changing the temperature of a saturated or nearly saturated solution in the direction of decreased solubility.

(3) Chemical additives are most commonly used. Typical reagents are:

(a) Sodium hydroxide, sodium sulfide.

(b) Hydrated lime ($\text{Ca}(\text{OH})_2$).

(c) Iron salts such as iron sulfide, ferric sulfate.

(d) Phosphate salts (especially for heavy metals such as As, Cd, Cr, Zn, Cu, Pb, Hg, Ni).

(e) Alum ($\text{Al}_2(\text{SO}_4)_3$).

(4) The theoretical removal limit for many metal species is very low, particularly with sulfide precipitants. Figure 4-12 shows theoretical curves as a function of waste pH. Some organic species, for example, aromatic compounds and phthalates, can also be treated. Removal in practice often is one to two orders of magnitude less than the theoretical limit. Complexing agents, such as cyanide or ethylenediamine tetra-acetic acid (EDTA), may compete with the precipitant and hold the species in solution.

(5) Conventional precipitation processes are performed in the following three steps:

(a) Rapid mixing of precipitating chemicals and waste water.

(b) Slow mixing of treated waste water in a flocculation tank to allow settleable flocs to form.

(c) Sedimentation of solids in a clarification tank.

(6) The solids are removed by either:

(a) Sedimentation, which separates the phases by the gravitational settling of the precipitate to the bottom of the sedimentation tank.

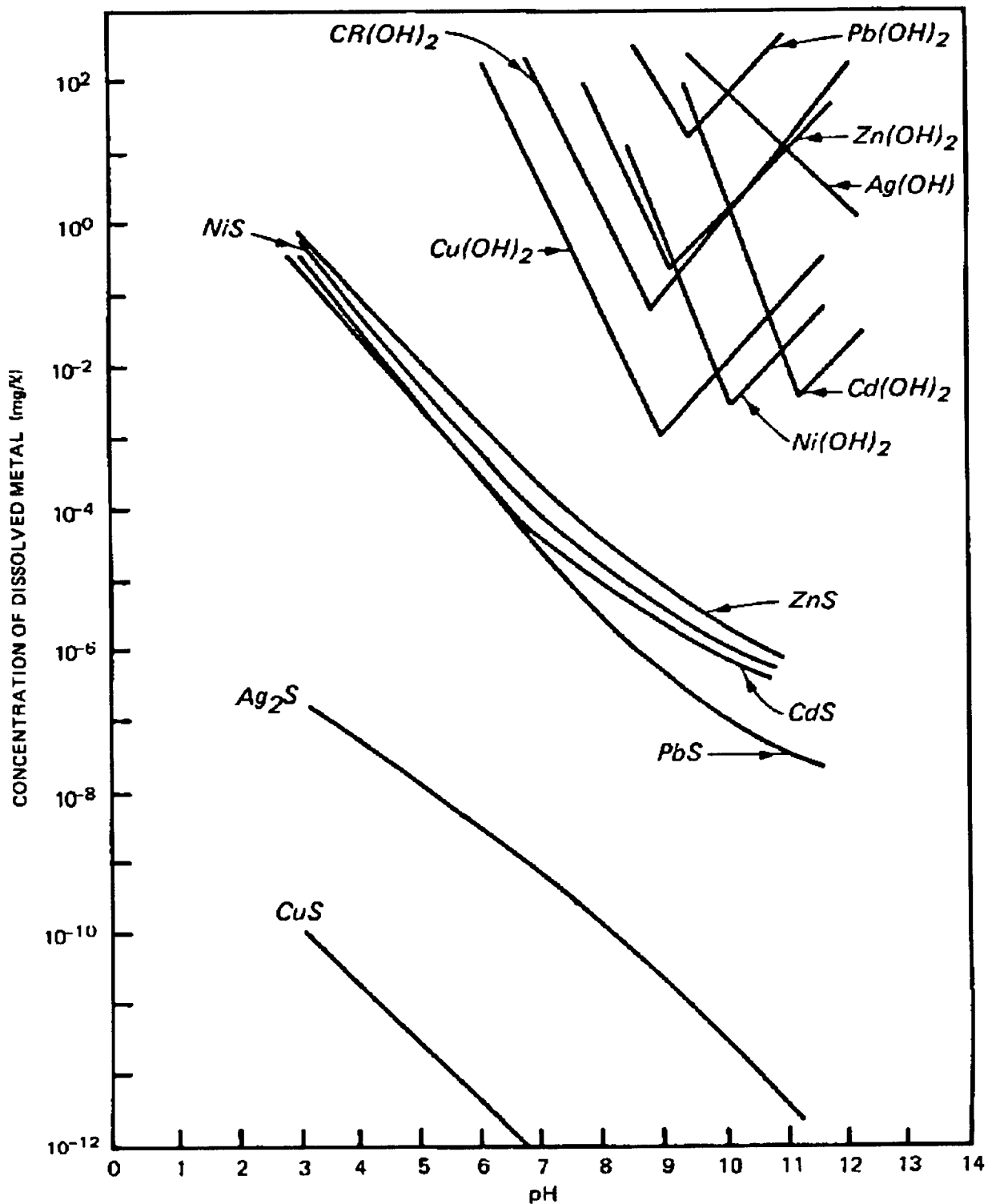

Figure 4-12. Solubility of Metal Hydroxides and Sulfides
(Source: Ghassemi et al. 1981, EPA 1983)

(b) Filtration, which separates the phases by passing the precipitation effluent through a granular or cloth barrier, retaining the particles and allowing the clear effluent to pass through.

(c) Centrifugation, which separates the two phases in an enclosed vessel using centrifugal force to cause the solids to migrate through the liquid.

b. Applications.

(1) Precipitation is a process that finds its primary application in the area of metals removal. However, it may also be used to precipitate long chain or high molecular weight organic materials.

(2) Typically, metals are precipitated as the hydroxide and removed by sedimentation. Removals are limited by the physics of the system. Solubilities of metal sulfides and metal xanthates are much lower than the hydroxide and consequently may be used in situations where very low concentrations are required.

c. Advantages/Disadvantages. The technique of precipitation is widely used for treating waste containing metals. This concept enjoys a technology based upon thermodynamics which provides a theoretical base for the consideration of a multitude of operations. Limitations are also defined by thermodynamics.

(1) The extent of removal is governed by the physics of the system.

(2) High TDS reduces performance, requiring the use of activity coefficients.

(3) Chelating agents can drastically reduce performance.

(4) A variety of anions may be used to improve performance.

(5) Precipitate will usually require a coagulation and/or flocculation step.

d. Data Requirements. In most cases, data will be available in the literature for pure single component systems without interferences. These data should be adequate for planning level design. However, this should be confirmed by bench or pilot plant testing.

e. Design Criteria. Solubility relationships are generally much more complex than indicated in the preceding discussion. In natural waters or waste waters, several other factors must be considered in order to make a realistic solubility product calculation. The ionic strength of the solution affects ion activity and must be considered if more exact calculations are desired.

4-11. Flocculation and Sedimentation. Flocculation and sedimentation are well-developed waste-water treatment processes currently being applied to the full-scale treatment of many industrial waste waters containing particulates and/or soluble heavy metals. The operating parameters and economics associated with the application of flocculation and sedimentation to the treatment of specific industrial waste-water streams are well defined and well documented (refer to CAPDET for design considerations).

a. Process Description.

(1) Historically, the terms "flocculation" and "coagulation" have been used rather indiscriminately and interchangeably to describe the process by which small, unsettleable particles suspended in a liquid medium are made to agglomerate into larger, more settleable particles. For the purpose of this manual, the term "flocculation" shall be defined so as to encompass all of the mechanisms by which suspended particles agglomerate into larger particles. No distinction will be made between coagulation and flocculation.

(2) A variety of mechanisms are involved in the process of flocculation whereby small particles are made to form larger particles. Most of these mechanisms involve surface chemistry and particle charge phenomena. In simple terms, these various phenomena can be grouped into two sequential mechanisms:

(a) Chemically induced destabilization of the repulsive surface-related forces, thus allowing particles to stick together when contact between particles is made.

(b) Chemical bridging and physical enmeshment between the now nonrepelling particles allows for the formation of large particles.

(3) Typical chemicals used to cause flocculation include alum, lime, and various iron salts (ferric chloride, ferrous sulfate). Organic flocculating agents, often referred to as "polyelectrolytes," have come into widespread use. These materials generally consist of long-chain water-soluble polymers such as polyacrylamides. They are used either in conjunction with the inorganic flocculants such as alum or as the primary flocculating agent alone.

(4) The inorganic flocculants, such as alum, lime, or iron salts, make use of precipitation reactions. Alum (hydrated aluminum sulfate) is typically added to aqueous waste streams as a solution. Upon mixing, the slightly higher pH of the water causes the alum to hydrolyze and form fluffy, gelatinous precipitates of aluminum hydroxide. These precipitates, partially due to their large surface area, act to enmesh small particles and thereby cause larger particles. Lime and iron salts, as well as alum, are used as flocculants primarily because of this tendency to form large fluffy precipitates or "floc" particles. Many precipitation reactions, such as the precipitation of metals from solution by the addition of sulfide ions, do not readily form floc particles, but rather precipitate as very fine and relatively stable colloidal particles. In such cases, flocculating agents such as alum and/or polyelectrolytes must be added to cause flocculation of the metal sulfide precipitates.

(5) In the flocculation process, it is essential that the slow mixing step be very gentle and be given sufficient time, as newly agglomerated particles are quite fragile and can be broken apart by shear forces during mixing. Once suspended particles have been flocculated into larger particles, they can usually be removed from the liquid by sedimentation, provided, of course, that a sufficient density difference exists between the suspended matter and the liquid.

(6) Sedimentation is a purely physical process whereby particles suspended in a liquid are made to settle by means of gravitational and inertial forces acting on both the particles suspended in the liquid and the liquid itself. The fundamental elements of most sedimentation processes are:

(a) A basin or container of sufficient size to maintain the liquid to be treated in a relatively quiescent state for a specified period of time.

(b) A means of directing the liquid to be treated into the above basin in a manner which is conducive to settling.

(c) A means of physically removing the settled particles from the liquid (or the liquid from the settled particles, whichever the case may be).

(7) Clarifiers are gravity separation devices and are usually the type of equipment used in applications that involve precipitation and flocculation in addition to sedimentation. Very often, all three processes take place within the same piece of equipment (clariflocculator) since many clarifiers are equipped with separate zones for chemical mixing and precipitation, flocculation, and settling. Certain clarifiers are equipped with low lift turbines which mix a portion of the previously settled precipitates with the incoming feed, as this practice has been shown to enhance certain precipitation reactions and promote favorable particle growth. (This type of clarifier is often used in water-softening applications involving the precipitation of calcium as calcium carbonate.)

b. Applications. The processes of flocculation and sedimentation are suitable treatment methods whenever it is necessary to remove suspended particulates and/or soluble heavy metals. The most common applications suitable for hazardous waste sites will include:

(1) Settling of suspended solids from surface water run-off.

(2) Removal of soluble and insoluble toxic metals.

(3) Removal of soluble inorganics natural to ground-water supplies.

Many toxic metals, including cadmium, lead, arsenic, and chromium, are removed to some degree from waste waters by these processes. There is no upper limit on the concentrations that can be treated by these processes. The lower limit for removal of soluble species is generally governed by the solubility product of the particular ion, although this method of predicting removal efficiency is not very reliable.

c. Advantages/Disadvantages. The major advantages and disadvantages of flocculation and sedimentation as applied to hazardous waste sites are summarized below:

<u>Advantages</u>	<u>Disadvantages</u>
Can be economically applied to very large volumes of leachate or ground water	Often yields incomplete removal of many hazardous compounds
Widely used, equipment is relatively simple	Large quantities of hazardous sludges may be generated
Very low energy consumption	Equipment may be difficult to obtain for flows of less than 37.9 m ³ /day (-10,000 gpd)
No upper limit to concentrations that can be treated	Because of continually changing leachate quality, required dosages of coagulants will continuously change

d. Data Requirements.

(1) The required dosage of coagulant depends upon pH, alkalinity, phosphate levels, and mode of mixing; dosage can be determined by jar tests and zeta potential tests. Typical chemical dosages used in industrial treatment processes are listed in Table 4-15. The hydraulic loading, also listed in Table 4-15, is used as a basis for determining suspended solids removal efficiencies. The hydraulic loadings shown are intended to achieve 80 to 90 percent suspended solids removal.

Table 4-15. Chemical Treatment of Industrial Waste Water by Coagulation

<u>Criteria</u>	<u>FeCl₃</u>	<u>Alum</u>	<u>Ca(OH)₂</u>
Dose, mg/l	80-120	100-150	350-500
Hydraulic loading, m ³ /m/m ² (gpm/sq ft ¹)	1.2x10 ⁻³ to 1.6x10 ⁻³ (0.3-0.4)	8.2x10 ⁻⁴ to 1.6x10 ⁻³ (0.2-0.4)	2x10 ⁻³ to 3.3x10 ⁻³ (0.5-0.8)
Chemical sludge production, mg/l (lb/million gal)	42-84 (350-700)	30-60 (250-500)	480-839 (4,000-7,000)

¹Without use of polyelectrolytes.

(2) Other data required to size the settling basins will include:

- (a) Waste stream daily and peak flows.
- (b) Settling velocity.
- (c) Waste stream analysis for size distribution and solids and liquid specific gravity.

e. Design Criteria.

(1) The effectiveness of a particular flocculant varies in different applications, and in a given application each flocculant has an optimum concentration and pH range. The process of flocculation requires rapid mixing followed by a slow and gentle mixing to allow contact between small particles and agglomeration into larger particles. Rapid mixing for coagulants especially inorganic coagulants such as alum is required to completely disperse the coagulant into the water immediately. Rapid mixing is usually accomplished in 10 to 60 seconds. A mean temporal velocity gradient in excess of 91 m/s (300 feet per second per foot) is recommended. After achieving an effective mix, promotion of particle growth by flocculation during the slow mix step is next. Flocculation is accomplished in 15 to 30 minutes with a mean temporal velocity gradient of 40 to 80 meters per second per meter (40 to 80 feet per second per foot). The lower value is for fragile floc (aluminum or iron), and the higher value is for a lime floc (Azad 1976).

(2) Sedimentation may be carried out in a separate basin from flocculation or it may be carried out in the same basin with both flocculation and precipitation. Figures 4-13 and 4-14 present schematics of an "in-line" system and a sludge-blanket type unit in which all three processes are carried out in a single unit. Criteria for sizing settling basins are overflow rate (surface settling rate), tank depth at the side walls, detention time which usually averages 1 to 3 hours, and surface loading rates which average 1.5 to 2.5 m³/d/m² (360 to 600 gallons per day per square foot) for alum floc, 2.2 to 4.9 m³/d/m² (540 to 1,200 gallons per day per square foot) for lime floc, and 2.9 to 3.3 m³/d/m² (700 to 800 gallons per day per square foot) for FeCl₃. In selecting the particular tank shape, proportions, equipment, etc., the designer should:

- (a) Provide for even inlet flow distribution in a manner that minimizes inlet velocities and short-circuiting.
- (b) Minimize outlet currents and their effects by limiting weir loadings and by proper weir placement.
- (c) Provide sufficient sludge storage depths to permit desired thickening of sludge. Solids concentrations of two to seven percent should be obtained.
- (d) Provide sufficient wall height to give a minimum of 457 mm (18 inches) of freeboard.
- (e) Reduce wind effects on open tanks by providing wind screens and by limiting fetch of wind on tank surface with baffles, weirs, or launders.

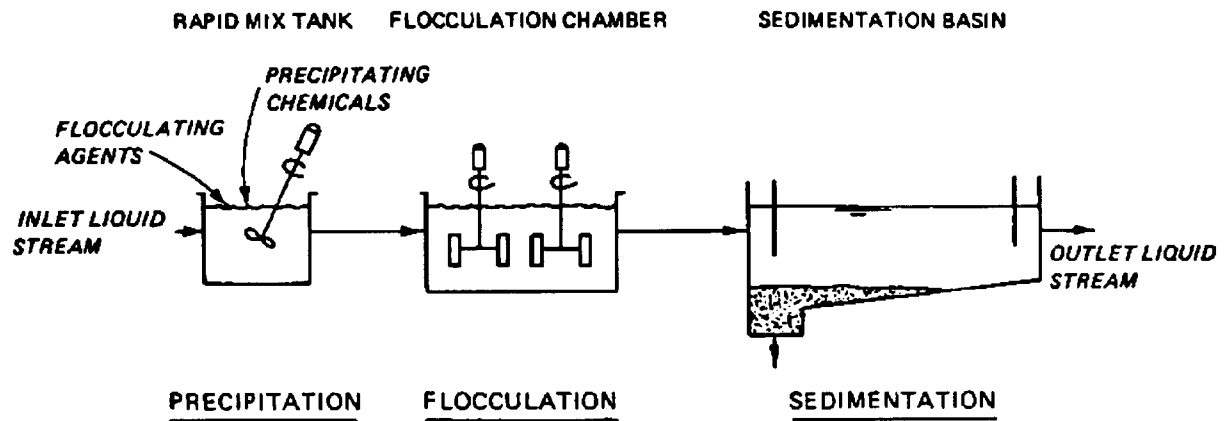

Figure 4-13. Representative Configuration Employing Precipitation, Flocculation, and Sedimentation

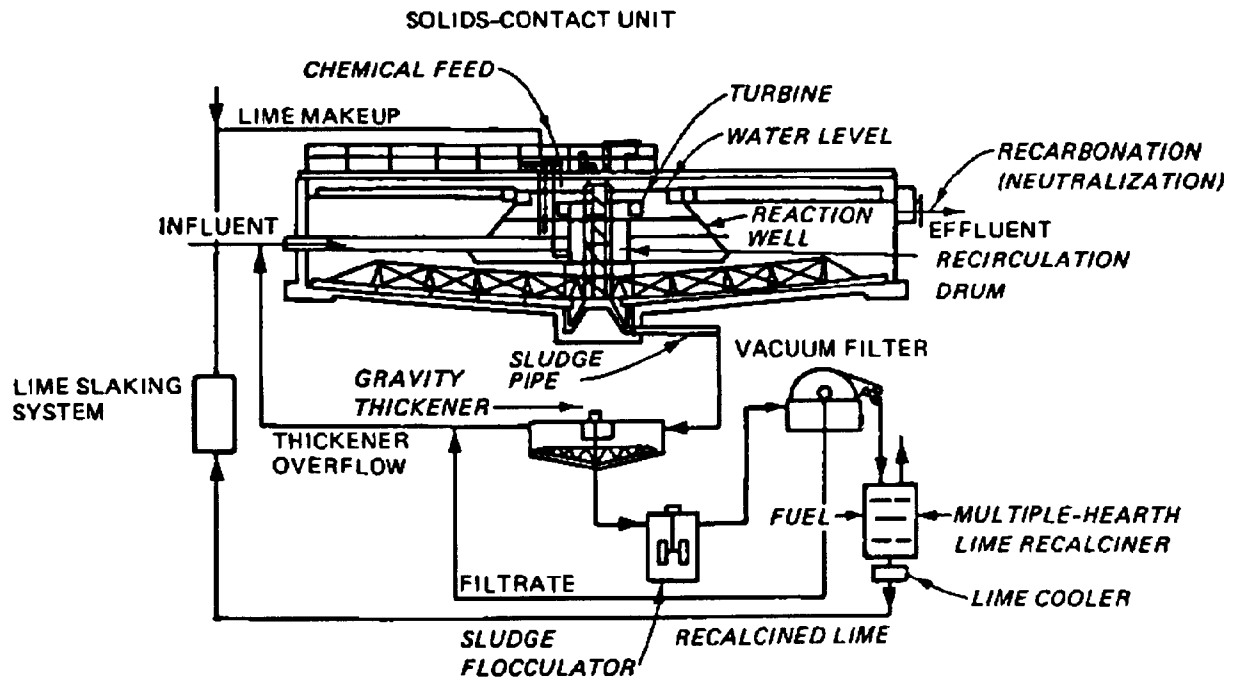

Figure 4-14. Typical Solids Contact Chemical Treatment System

(f) Consider economy of alternative layouts that can be expected to provide equivalent performance.

(g) Maintain equal flow to parallel units. This is most important and often forgotten. Equal flow distribution between settling units is generally obtained by designing equal resistances into parallel inlet flow ports or by flow splitting in symmetrical weir chambers.

4-12. Neutralization.

a. Process Description.

(1) The neutralization process described herein is intended for use in two different ways. The word "neutralization" implies a neutral pH of 7.0. However, in the present context, the process will be used to describe the adjustment and control of pH at a specified level.

(2) Many manufacturing processes generate waste streams that are acidic or alkaline in nature. Before such wastes can be discharged to the environment, the pH must be adjusted to be within the EPA-specified range, usually 6 to 9.

(3) Adjustment of pH may also be desirable to control chemical reaction rates and to effect precipitation. For example, in the reduction of chromium (VI) to chromium (III), the pH must be lowered to 3.0 or less in order for the reaction to proceed at a satisfactory rate. In order to precipitate the chromium (III), the pH must be raised to between 8 to 8.5.

(4) The basic principle behind the process is simple: the mixing of an acid or a base with a process stream to bring about the desired pH. Typically, the process is carried out in a completely stirred reactor (CSTR).

(5) The addition of appropriate quantities of neutralizing agent is monitored and adjusted by pH measurements and control. Generally, these systems are of a continuous flow variety and use automatic pH monitors to check the acidity or alkalinity and control the feeding of neutralizing agent. The number of neutralization units and the location of pH sensors are determined by the stability of the waste stream pH. Where widely varying pH levels are experienced, several reaction units plus additional monitoring equipment may be required. A stream with large fluctuations in pH might also be preceded by an equilization basin which would yield a more consistent feed with a limited pH range.

(6) The choice of a neutralizing agent is dictated by a number of factors such as economics, availability, and process compatibility. Commonly, the choice of an acid for neutralizing alkaline waste is sulfuric acid, whereas the choice for an acid stream may be lime or caustic.

b. Applications. Neutralization is a treatment process of demonstrated technical and economic feasibility industry wide. Two primary applications are intended here and are as follows:

(1) Neutralize a waste stream to a suitable level such that it can be discharged to the environment.

(2) Adjust pH of a waste stream to a specified level that would be suitable for carrying out chemical reactions or further treatment.

c. Advantages/Disadvantages. Advantages and disadvantages of neutralization are summarized below:

<u>Advantages</u>	<u>Disadvantages</u>
Proven and simple process	Does not remove or degrade pollutants, rather adds them
Some waste may be discharged directly following neutralization	pH controllers require frequent maintenance
Can provide favorable conditions for oxidation/reduction reactions	May require equalization as pretreatment
Can provide conditions favorable to precipitation of metals	May generate large amounts of heat

d. Data Requirements. Data requirements include:

- (1) Average daily flow; peak flow.
- (2) pH range of influent stream.
- (3) Desired control pH.
- (4) Equivalentents per liter of alkalinity or acidity to be neutralized.

e. Design Criteria.

(1) If the influent hydraulic flow is expected to vary significantly, equalization should be considered for pretreatment. This approach is also true for wide fluctuations in the influent pH.

(2) A CSTR with 10 to 20 minutes residence time should suffice in most cases. Neutralization reactions are typically very fast. There may be, however, extenuating circumstances that would make it desirable to increase or decrease this time. A larger volume would tend to stabilize the control system. On the other hand, if pH adjustment is being carried out in a number of stages, retention time may be reduced to a minimum.

(3) Feed systems and storage tanks must be provided for acid and/or base for neutralization. If lime is used, a slurry tank may be required.

(4) If strong acids require neutralization with strong bases, care must be exercised to consider the potential for a violent exothermic reaction. This situation should be avoided if at all possible.

4-13. Oil-Water Separation.

a. Process Description.

(1) Oil-water separators may be of several different types that utilize either gravity or mechanical acceleration to separate phases of varying density. Gravity separators are more commonly called API (American Petroleum Institute) separators. This terminology stems from a hydrometer scale in °API that is used by the petroleum industry to specify the specific gravity of petroleum products.

(2) An API separator consists of a settling chamber that allows oil to separate from an aqueous phase and rise to the surface, a baffle and oil skimming device that prevents the loss of the oil phase to the effluent while continuously removing the surface oil, and a holding basin that collects and stores the oil until final disposal is desired.

(3) Gravity separators should be used only for gross oil-water separators. They are not intended for removals to low parts per million levels. Also, they should not be used for emulsified oil and grease.

(4) Low-level oil removal may require a membrane process, centrifugation, chemical coagulation, or carbon adsorption. One or more of these processes may be used after the API separator. A flow diagram for an API separator is presented in Figure 4-15.

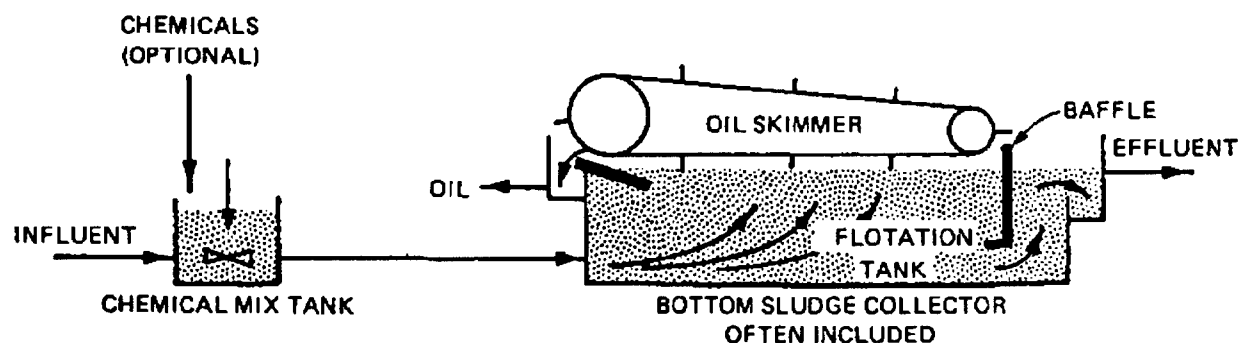

Figure 4-15. Flow Diagram for API Separator

b. Application.

(1) API are gravity separators which are technically simple oil-water separators that have found wide usage at manufacturing facilities. They are used to separate residual oil from washing down floors, equipment, parts, compressor blowdown, and spillage.

(2) Gravity separators are typically used as a pretreatment step before further processing of the waste water. Oil is automatically skimmed and collected in a holding basin where it is held for final disposition. Residual oil in the effluent may be removed in subsequent treatment steps, or specific processes may be required in the process train for total removal, perhaps carbon adsorption.

c. Advantages/Disadvantages. Advantages and disadvantages of oil/water separators are summarized below:

<u>Advantages</u>	<u>Disadvantages</u>
Provide excellent gross oil removal	Cannot treat emulsified oil or oil droplets smaller than 0.015 centimeters
Proven, inexpensive technology	Separated oil requires disposal and water phase may require further treatment
Variety of proprietary units are readily available	Short-circuiting may be a problem
	Sensitive to shock loadings

d. Data Requirements. Data requirements are as follows:

- (1) Hydraulic flow, average and peak.
- (2) Size of oil droplet to be removed.
- (3) API or density of oil.
- (4) API or density of water phase.
- (5) Viscosity of fluid.
- (6) Expected operating temperature.

e. Design Criteria.

(1) Gravity separators are based upon the rise rate of oil droplets of a specified size and density. These droplets rise to the surface or to a baffle and then to the surface within the retention time provided. A skimming device then physically removes the oil to a holding facility.

(2) Rise rates are amenable to theoretical considerations through a rather simple force balance on the system. These forces include drag, buoyant, and gravitation forces. The design of oil separators as developed by the American Petroleum Institute is based upon removing oil droplets that are larger than 0.015 centimeter in diameter. The Reynolds number for this situation can be shown to be less than 0.5. This says that, for spherical

particles, laminar flow can be assumed with little error and Stoke*s law is applicable.

(3) Stoke*s law describes the terminal settling velocity of a particle as a function of the particle and medium density, particle diameter, and drag characteristics. Stokes equation is as follows:

$$V_t = \frac{(P_s - P) g D_p^2}{18u} \quad (4-5)$$

where

V_t = terminal settling velocity, cm/sec

P_s = density of particle, g/cm³

P = density of fluid, g/cm³

g = gravitational constant, cm/sec²

D_p = diameter of particle, cm

u = viscosity of fluid, dyne-sec/cm²

(4) The API design procedure must consider short-circuiting and turbulence for best performance.

4-14. Dissolved Air Flotation.

a. Process Description.

(1) Flotation is a solid-liquid separation process. Separation is artificially induced by introducing fine gas bubbles (usually air) into the system. The gas-solid aggregate has an overall bulk density less than the density of the liquid; thus, these aggregates rise to the surface of the fluid. Once the solid particles have been floated to the surface, they can be collected by a skimming operation.

(2) Air flotation systems may be classified as dispersed air flotation or dissolved air flotation. In dispersed air flotation, air bubbles are generated by introducing air through a revolving impeller or porous media. This type of flotation system is usually ineffective and finds very limited application in waste-water treatment. Dissolved air flotation may be subclassified as pressure flotation or vacuum flotation. Pressure flotation involves air being dissolved into the waste water under elevated pressures and later released at atmospheric pressure. Vacuum flotation consists of applying a vacuum to waste water aerated at atmospheric pressure. Dissolved air-pressure flotation considered herein is the most commonly used in waste-water treatment.

(3) The principal components of a dissolved air-pressure flotation system are a pressurizing pump, air injection facilities, a retention tank, a back-pressure regulating device, and a flotation unit. The primary variables for flotation design are pressure, recycle ratio, feed solid concentration, detention period, air-to-solids ratio, use of polymers, and solids and hydraulic loadings. Optimum design parameters must be obtained from bench scale or pilot plant studies. A flow diagram for a dissolved air flotation system is presented in Figure 4-16.

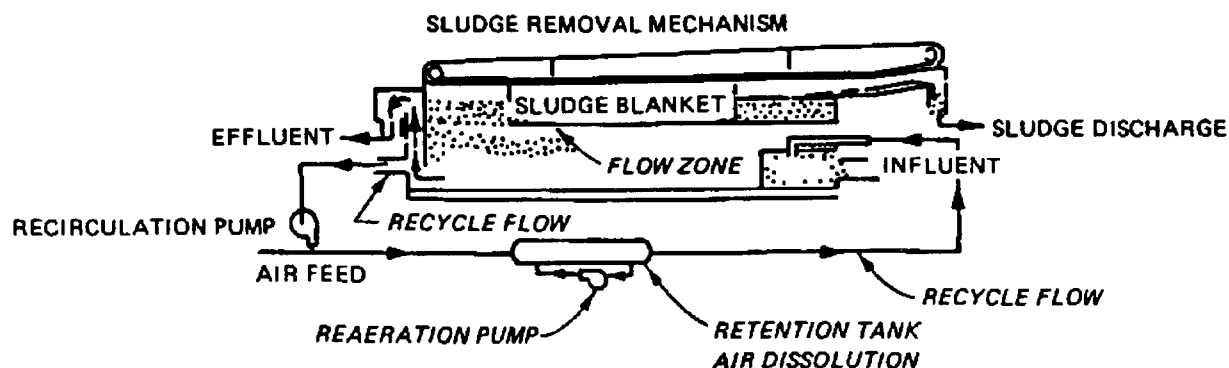

Figure 4-16. Flow Diagram for Dissolved Air Flotation System

b. Applications. In waste-water treatment, flotation is used as a clarification process to remove suspended solids and as a thickening process to concentrate various types of sludges. However, high operating costs of the process generally limit its use to clarification of certain industrial wastes and for concentration of waste-activated sludge. In industrial practice, with wastes containing total suspended solids (TSS) and oil and grease levels up to 900 milligrams per liter, removal efficiency of 90 percent has been recorded.

c. Advantages/Disadvantages. Advantages and disadvantages of dissolved air flotation are summarized below:

Advantages	Disadvantages
Requires very little land area	Only effective on particles with densities near that of water
Well documented and available technology	Varying influent will affect performance
Air released in unit unlikely to strip volatile organics	Sludge generated will require disposal

d. Data Requirements. Required design information includes:

- (1) Waste stream daily average flow.

- (2) Waste stream temperature.
- (3) Waste stream oil/grease or suspended solids concentration.
- (4) Treatability tests to determine air requirements and pressure.

e. Design Criteria.

(1) Major design variables and corresponding operating conditions are:

(a) System pressure, 276-413 kPa (40-60 psig) (pounds per square inch, gage).

$$\frac{A}{S} = \frac{1.3s_a(fP - 1)}{S_a}$$

Temp., °C	0	10	20	30
s _a , ml/l	29.2	22.8	18.7	15.7

where

A/S = air to solids ratio, ml (air)/mg (solids)

S_a = air solubility, ml/l

f = fraction of air dissolved at pressure P, usually 0.5

P = pressure, atm

$$= \frac{p + 14.7}{14.7} \quad (\text{U.S. customary units})$$

$$= \frac{p + 101.35}{101.35} \quad (\text{SI units})$$

p = gage pressure, lb/in² gage (kPa)

S_a = sludge solids, mg/l

The corresponding equation for a system with only pressurized recycle is

$$\frac{A}{S} = \frac{1.3s_a(fP - 1)R}{S_aQ}$$

where

R = pressurized recycle, Mgal/d (m^3/d)

Q = mixed-liquor flow, Mgal/d (m^3/d)

In both equations, the numerator represents the weight of air and the denominator the weight of the solids. The factor 1.3 is the weight in milligrams of 1 ml of air, and the term (-1) within the brackets accounts for the fact that the system is to be operated at atmospheric conditions. The required area of the thickener is determined from a consideration of the rise velocity of the solids, 0.2 to 4.0 gal/m \cdot ft² (8 to 160 $\ell/\text{m}^2 \cdot \text{min}$), depending on the solids concentration, the degree of thickening to be achieved, and the solids-loading rate.

(b) Hydraulic loading, $4.1 \times 10^{-3} - 1.6 \times 10^{-2} \text{ m}^3/\text{min}/\text{m}^2$ (1-4 gpm/ft²).

(c) Retention period, 20-40 mm.

(2) It is common engineering practice to triple the calculated A to provide a safety factor and excess air for high dissolution efficiency.

(3) The hydraulic loading rate (referred to as surface loading rate (SLR)) is determined by plotting laboratory experimental values of effluent pollutant concentrations versus surface loading rates. The rate which is sufficient to achieve effluent water quality goals is identified from the graph.

(4) The retention time equation is

$$t = \frac{d}{\text{SLR}} \quad (4-7)$$

where a depth of 1.2 to 2.7 m (4 to 9 feet) is typically chosen (EPA 1980).

4-15. Reverse Osmosis.

a. Process Description.

(1) Osmosis is the movement of a solvent through a membrane which is impermeable to a solute. If a salt solution is separated from water by means of a semipermeable membrane, there will be a net transport of water in the direction of the salt solution. This phenomenon develops a hydrostatic pressure known as "osmotic pressure." It may also be defined as the excess pressure that must be applied to the solution to produce equilibrium.

(2) Reverse osmosis removes contaminants from aqueous wastes by passing the waste stream, at high pressure, through a semipermeable membrane. At sufficiently high pressure, usually in the range of 1378 to 2756 kPa (200 to 400 pounds per square inch), pure water passes out through the membrane leaving a more concentrated waste stream. As the waste stream becomes more concentrated, the osmotic pressure increases and consequently requires addi-

tional external pressure to maintain the flow in the proper direction, hence the name reverse osmosis.

(3) The semipermeable membrane itself is perhaps the most critical part of reverse osmosis (RO). At present, commercial RO membranes are made from two types of polymers. The first membranes developed were cellulose acetate. The second type of membranes were developed from cellulose triacetate. Both membranes can be prepared in sheet form with water fluxes of 4.1×10^{-2} - 8.2×10^{-2} m³/day/m² (10 to 20 gallons per day per square foot) at 2756 kPa (400 pounds per square inch). Polyamine membranes are being developed but, at present, they have no resistance to chlorine.

(4) The design of the modules containing the RO membranes is crucial to the efficient operation of the process. As solute is rejected by the membranes, it concentrates at the membrane surface and results in a situation known as "concentration polarization," where the concentration at the membrane surface is many times higher than in the bulk feed solution. Since the driving force for water transport decreases with increasing concentration, polarization can have a very deleterious effect on water flux.

(5) Concentration polarization can be minimized by high fluid shear at the membrane surface to aid the back-transport of polarized solute into the bulk of the process stream. This is accomplished by flowing the feed stream at high velocities in thin channels to promote laminar shear, or in wide channels to produce turbulence. RO membranes can be spiral wound, hollow fine fiber, tubular, or flat membrane.

(6) One of the difficulties with RO membranes is their susceptibility to fouling by film-forming organics or insoluble salts. It is common practice to preprocess feed water as necessary to remove oxidizing materials, iron, and magnesium salts; to filter out particulates; and to remove oils, greases, and other film-formers. If there is likelihood of fouling by living organisms, chlorination or UV treatment may be employed as well to ensure that maximum flux rates may be obtained. A typical flow sheet for an RO plant is shown in Figure 4-17.

b. Applications.

(1) RO systems are in extensive use throughout the world in generating potable water. Over 2.27×10^5 m³/day (60,000,000 gallons per day) in capacity is now in operation.

(2) The number of plants in use to treat industrial waste water is not clearly defined but appears to be significant. Specific applications include:

- (a) Preparation of pure water and process feed water.
- (b) Preparation of rinse water in semiconductor and electronic manufacturing.
- (c) Purification of water for hospital use.

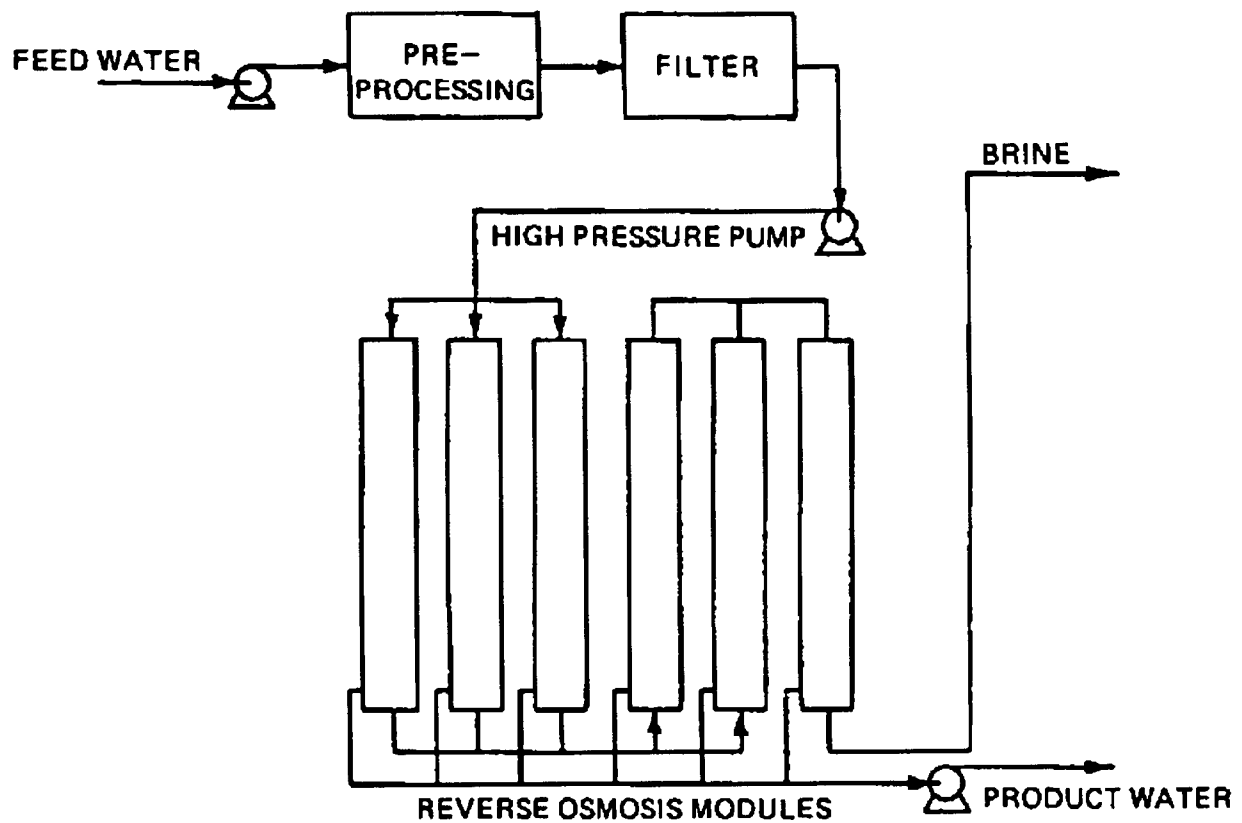

Figure 4-17. Reverse Osmosis Plant Flow Sheet

- (d) Reclamation of electroplating chemicals.
 - (e) Recovery of sugar wastes by candy manufacturers.
- (3) Industrial waste treatment offers a great potential for RO. This process should be considered when it is desirable or necessary to accomplish:
- (a) A reduction in the waste volume.
 - (b) Recovery of valuable or reusable materials.
 - (c) Water conservation and recovery.
 - (d) The concentration of pollutants for further processing.
- c. Advantages/Disadvantages. Advantages and disadvantages of reverse osmosis are listed below:

<u>Advantages</u>	<u>Disadvantages</u>
Capable of high salt rejection	Requires high operating pressure and extensive pretreatment
Produces high purity solvent	Subject to membrane fouling and compression
Applicable to small installations	Cannot be used for fractionation
Provides for water conservation and use	Proportion of reject water may be too high to be acceptable

d. Data Requirements.

(1) A variety of proprietary designs for RO units are available from numerous manufacturers. These suppliers will usually supply the following pertinent information with regard to their particular system and for a variety of membranes:

- (a) Packing density, m^2/m^3 (ft^2/ft^3).
- (b) Water flux at a specified pressure and temperature.
- (c) Sodium chloride rejection.
- (d) Acceptable pH ranges.
- (e) Recommended operating pressure.

(2) Data with regard to specific waste are also required that must be determined experimentally from bench scale studies. Manufacturers and suppliers are usually eager to be of help in this area.

(3) One important piece of information that must be determined for any specific application is pretreatment requirements. In general, pretreatment will always be required and should be carried out to:

- (a) Remove excess turbidity and suspended solids.
- (b) Adjust pH to desirable level.
- (c) Adjust temperature of feed.
- (d) Control the formation of components that tend to precipitate.
- (e) Disinfect to prevent slime growth.
- (f) Remove oil and grease that may be present.

(4) Data regarding flux rates must be determined experimentally. Flux decline is a serious operational problem that must be given the proper attention. Membrane compaction and membrane fouling are responsible for reductions in flux. Membrane compaction is a function of membrane type, operating temperature, pressure, and time.

e. Design Criteria.

(1) The design of an RO system is based upon the feed water composition, variability, temperature, and osmotic pressure. Rejection of various components in the feed stream by a specific membrane flow rate usually dictates the number of units or size of the plant. Product quality is difficult to predict but can be varied by adjusting product recovery.

(2) When plant capacity and energy requirements are established, the membrane requirements must be set. Membrane considerations include the expectancy, compaction, fouling, and operating net pressure. If, for example, data are available for a certain membrane that would suggest a flux of 10 gallons per square foot per day at 70°F at 500 pounds per square inch is applicable, the membrane requirement for a 100,000 gallons-per-day facility would be 10,000 square feet of membrane. It is common design practice to base the design flux upon the expected volume after 1 year of operation which may reduce flux rate by 10-15 percent. Membrane lifetime is critical.

(3) Minimization of concentration polarization is another design consideration. This is done by regulating the brine flow rate through the RO units. Since product is continuously being taken out, the brine flow is reduced. To compensate for this, units are staged in a series-parallel arrangement that is similar to an inverted pyramid.

4-16. Solidification/Stabilization. Solidification/stabilization technology as applied to wastes uses physical and chemical processes to produce chemically stable solids with improved contaminant containment and handling characteristics. Waste solidification is the term used to describe the process of sorbing a liquid or semiliquid waste onto a solid medium, such as fly ash, cement, kiln dust, or clay, or otherwise incorporating the waste in a solid matrix. This partial treatment eliminates any free liquid and reduces the risk of spillage or escape of contaminants in any liquid phase. This technology is discussed in detail in paragraph 4-21.

4-17. Ultrafiltration.

a. Process Description.

(1) Ultrafiltration and RO are similar processes and some confusion exists about their distinction. Both involve the transport of a solution under a pressure gradient through a semipermeable membrane to achieve at least partial separation of solvent molecules from solute molecules. In addition, both require a velocity vector parallel to the plane of filtration. The two processes differ because ultrafiltration is not impeded by osmotic pressure and can be effected at low pressure differences of 34.5 to 689 kPa (5 to 100 pounds per square inch). Ultrafiltration is usually applicable for separation

of solutes above a molecular weight of 500, which have very small osmotic pressures at moderate concentrations. These include such materials as bacteria, viruses, starches, gums, proteins, clays, and paint pigments. The upper molecular weight limit for ultrafiltration is usually defined as 500,000. Above that molecular weight size, separation occurs by conventional microporous filtrations.

(2) Concentration polarization effects in ultrafiltration are similar to those in RO except more severe. Since micromolecular diffusion constants are two to three orders of magnitude smaller than those of salts, back-diffusion to the bulk of the liquid is much slower. Figure 4-18 illustrates the impact of concentration polarization.

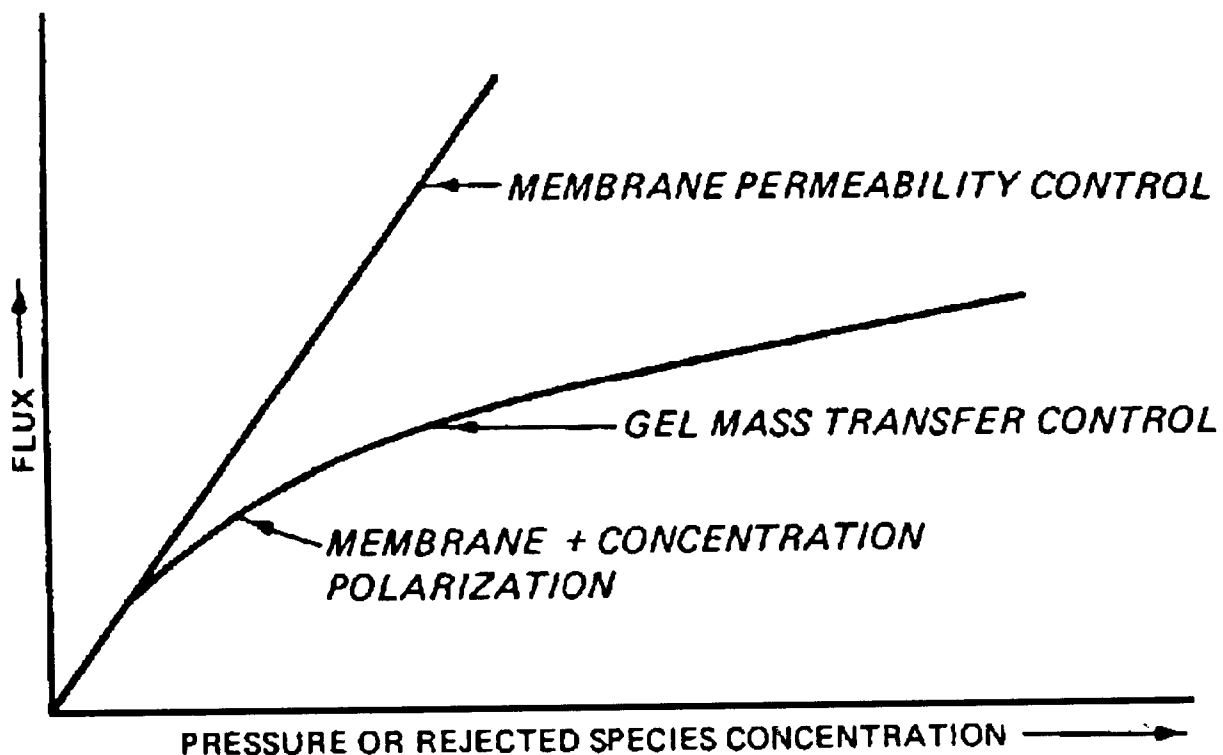

Figure 4-18. Effect of Concentration Polarization Upon Membrane Flux in Ultrafiltration

b. Applications.

(1) The properties of ultrafiltration membranes lead to a range of applications quite distinct from those of conventional filtrations. Where solutes are being separated from solution, ultrafiltration can serve as a concentration or fractionation process for single-phase liquid streams. Thus, ultrafiltration competes with adsorptive and evaporative separation processes and has the potential for broader applicability than conventional filtration. Usually, it will not perform the entire task because it produces a concentrate

rather than a solvent-free product, and the concentrate requires further processing if a pure solute is to be recovered.

(2) Application of ultrafiltration may fall into one of three categories:

(a) Concentration, where the desired component is rejected by the membrane and taken off as a fluid concentrate.

(b) Fractionation, for systems where more than one solute is to be recovered, and products are taken from both the rejected concentrate and permeate.

(c) Purification, where the desired product is purified solvent.

(3) Table 4-16 summarizes major existing ultrafiltration applications. Also shown is the function of ultrafiltration processing for the specific application.

(4) Table 4-17 summarizes developmental applications of ultrafiltration. These represent areas which are likely to be commercial within the next 5 years. Table 4-16 indicates commercial applications and the nature of their technology.

Table 4-16. Commercial Applications of Ultrafiltration

Application	Function
Electrocoat	Fractionation
Paint rejuvenation and rinse water	Concentration and fractionation
Protein recovery from cheese whey	Concentration and fractionation
Metal machining, rolling, and drawing--oil	Purification
Emulsion treatment	Purification
Textile sizing (PVA) waste	Fractionation
Electronics component manufacturing washwater treatment	Purification
Pharmaceuticals manufacturing sterile water production	Purification

c. Advantages/Disadvantages. Ultrafiltration is a concentration process that is in competition with other membrane processes as well as evaporation processes. Its advantages and disadvantages are summarized below:

Advantages	Disadvantages
Operates at lower pressure than RO	Requires membranes that are subject to fouling
Can be used for fractionation	Limited range of particle sizes for which it is effective
Does not require pretreatment as RO, but can be used as pretreatment for RO	
Requires less capital than RO or evaporative processes	
Highly suitable for small flows and small installations	

Table 4-17. Development Applications of Ultrafiltration

Application	Function
Dye waste treatment	Concentration and purification
Pulp mill waste treatment	Concentration and purification
Industrial laundry waste treatment	Purification and fractionation
Protein recovery from soy whey	Concentration
Hot alkaline cleaner treatment	Fractionation and purification
Power plant boiler feedwater treatment	Purification
Sugar recovery from orange juice pulp	Fractionation
Product recovery in pharmaceutical and fermentation industries	Concentration
Colloid-free water pollution for beverages	Purification

d. Data Requirements.

(1) A variety of proprietary designs for ultrafiltration units are available from numerous manufacturers. These suppliers will usually supply the following pertinent information with regard to their particular system and for a variety of membranes:

- (a) Packing density, $1.5 \text{ m}^2/\text{m}^3$ ($5 \text{ ft}^2/\text{ft}^3$).
- (b) Water flux at a specified pressure and temperature.
- (c) Molecular weight cutoff or rejection.
- (d) Acceptable pH ranges.
- (e) Recommended operating pressure.

(2) Data with regard to specific waste are also required that must be determined or verified experimentally. Manufacturers and suppliers will usually provide assistance in this area. Flux rates and rejection should be determined experimentally.

e. Design Criteria.

(1) The approach to the design of an ultrafiltration system is similar to that for RO. In ultrafiltration design, concentration polarization effects are magnified, and care must be exercised to alleviate this problem. Typically, channels are designed for minimum height, and the unit is operated at a high parallel surface velocity.

(2) Operating pressures for ultrafiltration systems are in the range of 68.9 to 689 kPa (10 to 100 pounds per square inch) with 413 to 551 kPa (60 to 80 pounds per square inch) being typical. As is the case with RO, temperature plays a significant role in the flux rate of ultrafiltration membranes. Fluxes are expected to double for a 15° to 25°C rise in temperature. Operating temperatures are limited by economics and the material from which the membrane is constructed. Membranes produced from cellulose are limited to the 50° to 60°C range, while other membranes may be operated at temperatures as high as 100°C .

(3) Ultrafiltration membranes are specified in terms of molecular weight cutoff or a rejection of a specific molecular weight compound. This is not an absolute measure of rejection. In actuality, rejection is a function of molecular shape, size, and flexibility as well as the operating conditions.

Section II. Treatment of Sludges and Soils

4-18. Biological Treatment.

a. Bioslurry Reactors.

- (1) Process description.

(a) Bioslurry reactors (BSRs) (also referred to as liquid/solids reactors) are an innovative biological technology for rapid treatment of sludges and excavated soils. BSRs offer treatment conditions that are conducive to the optimal biotreatment of contaminated soils by slurring contaminated soils in water using liquid-to-solid ratios ranging from 20 to 50 percent. The soil/water slurries are usually kept in suspension using mechanical mixers,

injected air, recirculation pumps, and/or raker arms scraping the reactor bottom. Typically, BSRs are operated under aerobic conditions; however, BSRs can be configured for anaerobic treatment if warranted. BSRs can be operated in batch or continuous modes. Continuous flow systems are usually operated using multiple reactors in series. Figure 4-19 shows a typical schematic of a BSR system.

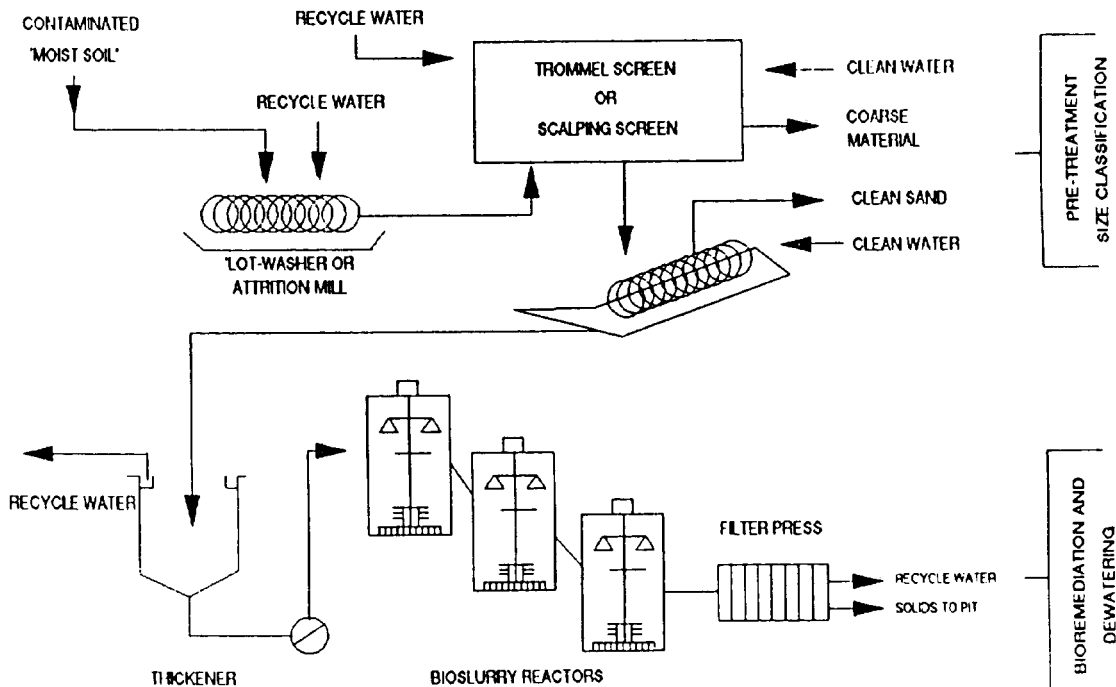

Figure 4-19. Typical Bioslurry Treatment System

(b) Many of the limiting conditions associated with other soil biotreatment technologies are substantially reduced in the BSRs. Oxygen transfer, usually a major limiting factor with the other soil treatment biotechnologies, especially in situ treatment, is improved due to increased mixing efficiency. Oxygen is supplied by the addition of air or oxygen via submerged gas spargers. Nutrients and co-metabolites may also be added depending on the required treatment conditions, usually determined through bench treatability studies. BSRs usually contain both attached and suspended growth consortia allowing for contaminant destruction in both phases. Microbial populations in BSRs are much higher than those found in other soil biotreatment systems due to the improved treatment conditions, thereby maximizing the degradation rate of contaminants due to improved microbe/contaminant contact and increased contaminant desorption rates.

(2) Applications.

(a) BSRs have proven effective in treating soils contaminated with petroleum hydrocarbon and wood preserving wastes. Some systems incorporate soil screening techniques prior to BSR treatment because the majority of the contaminants are sorbed to the finer fraction of the soils. BSR technology

can be applied in custom fabricated, stock commercially available, or earthen reactor units. Soil residence times will vary greatly depending on the contaminant type, concentration, and sorption characteristics.

(b) Various additives can be provided to improve process performance. Surfactants have been proposed to increase the desorption rate of contaminants. Nutrient additive requirements, typically presented as the carbon:nitrogen:phosphate ratio (C:N:P), are usually on the order of 100:20:5; however, recent research indicates that increased ratios may increase contaminant degradation rates. Most contaminated soils contain native microorganisms capable of degrading the target contaminants that simply require stimulation by the addition of a limiting chemical species such as oxygen and/or nutrients. Treatment of sludges and soils which are devoid of native microbial populations may require the addition of a microbial inoculum.

(c) Residuals from BSRs are the soil/water slurry that may require separation (i.e., dewatering). The amount of dewatering required will be dictated by disposal plans for the treated soils. Aqueous solutions usually do not contain organic constituents due to the ease of degradation of the contaminants in solution.

(d) Potential waste streams from a BSR are off-gasing of volatile compounds and heavy-metals-contaminated soil/water slurries if the soil was also contaminated with heavy metals. Gas streams from a BSR can be either eliminated or reduced by use of pure oxygen or possibly an alternate electron acceptor. Gas streams can also be treated using activated carbon canisters.

(3) Advantages/disadvantages. The advantages and disadvantages of BSRs are summarized in below:

<u>Advantages</u>	<u>Disadvantages</u>
Rapid decontamination of contaminants.	Fairly energy intensive.
Numerous process variations which allow for high degree of flexibility.	Capital costs can be high.
Contaminated off-gasing can be easily controlled for complete elimination of contaminant release into the environment.	O&M intensive.
Higher contaminant concentrations compared to other soil biotreatment technologies can be treated due to higher microbial populations.	Requires soil excavation.
Process can be implemented in a variety of reactor systems.	May require soil dewatering.
	Few full-scale implementation verification data available.

(4) Data requirements. Principal data requirements for design of BSRs are determined through bench scale studies due to the lack of empirically based design formulas. The following factors should be evaluated in a properly planned bench study:

- (a) Whether the target contaminants are best degraded under aerobic or anaerobic conditions.
- (b) Benefits of co-metabolite addition.
- (c) Benefits of surfactant addition.
- (d) Optimum C:N:P ratios
- (e) Potential for production of toxic chemical intermediates.
- (f) Effect of addition of an exotic microbial inoculum.
- (g) Retention time required to reach target contaminant levels.
- (h) Optimum soil/water ratio.
- (i) Potential for excessive foaming.

(5) Design criteria. Since there are few design criteria due to the limited evaluation and usage of this technology, the following design considerations must be addressed:

(a) Reactor volume - Reactor volume is dependent on soil retention time and required process flow.

(b) Soil screening - Required for soils containing either large coarse fractions or large debris that may damage the reactor.

(c) Mixing efficiency - High mixing efficiencies must be supplied to optimize the degradation rate of the target compound(s).

(d) Soil dewatering - May be required depending on soil disposal requirements.

(e) Oxygen requirements - Dependent upon the oxygen demands of the system determined during the bench study.

b. Composting.

(1) Composting is a biological treatment method which takes advantage of the heat of reaction during metabolism of organic carbon to sustain rapid decomposition. It is primarily used in treatment of sludges. There are three broad classifications of composting systems in use today. They are:

- (a) Windrow system

- (b) Aerated static piles
- (c) In-vessel, mechanically agitated

(2) The windrow system is the simplest of the three and relies on natural aeration or periodic mixing as a means of supplying oxygen to the system and reducing excessive heat buildup. Specially designed windrow forming and turning machines have found application in large-scale operations.

(3) Aerated static piles provide an increased level of process control. Waste to be composted is typically placed in piles on top of channels or piping through which air may be blown or sucked through the piles. In simpler systems, a timer is used to periodically aerate the pile, the cycle of aeration is determined by trial. In more sophisticated systems, temperature feedback control is utilized to aerate the piles, maintaining a preset temperature. In most instances, temperature control through aeration provides greater than the required oxygen for metabolism.

(4) The third system, the in-vessel, mechanically agitated system, is the most complex of the three and provides the highest degree of process control. Various designs have been developed. All allow composting in some form of vessel such as a tank, silo, or trench. Mechanical mixing of the compost through direct agitation or indirect tumbling is performed. Some systems incorporate forced aeration capabilities. As with aerated static piles, temperature is typically the control variable. In-vessel, mechanically agitated systems can be operated on a continuous basis. Figure 4-20 provides an example of the three types of systems.

(5) The primary objectives in sewage sludge treatment with composting are pathogen destruction, dewatering, and volume reduction. In some cases, the final product can be marketed as an agricultural additive. Essentially, the high temperatures achievable in compost systems are sufficient for pathogen destruction. Typically, 3 days at a temperature of 55 °C are required for pathogen destruction. Dewatering occurs as water in the compost mass is evaporated at the increased temperature. In aerated systems, water loss is even greater due to the transport out of the compost by the aeration stream. Volume reduction occurs as metabolism of the organic carbon with subsequent dewatering causes loss in mass and breakdown of internal structure. Addition of an amendment (additional organic carbon, nutrients, or inoculant) as well as bulking agents (wood chips, sawdust, hay, etc.) are often required to allow composting. In addition, water may be required as an additive during composting to maintain active conditions.

c. Applications.

(1) Composting is being used extensively in treatment of sewage sludge at municipal waste treatment plants. As optimum water content in the compost falls between 40 and 60 percent, composting usually does not involve a dewatering step prior to the process.

(2) Composting has been applied to a limited extent to process waste streams. Typically, it is more amenable to solid substrate treatment.

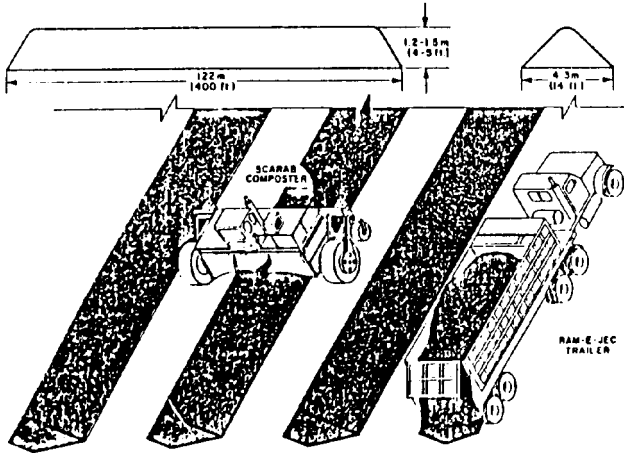

a. Typical windrow composting operation.

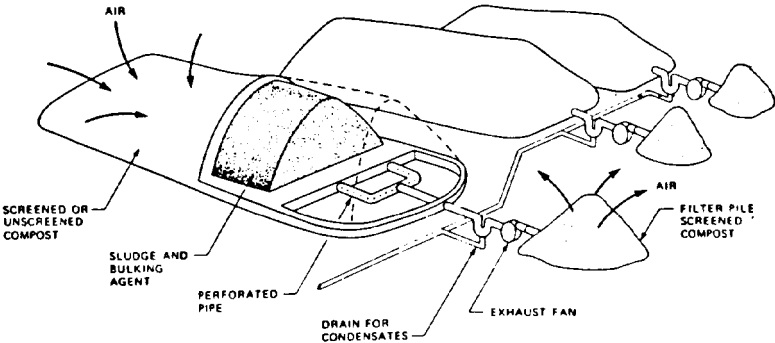

b. Typical aerated static pile composting system.

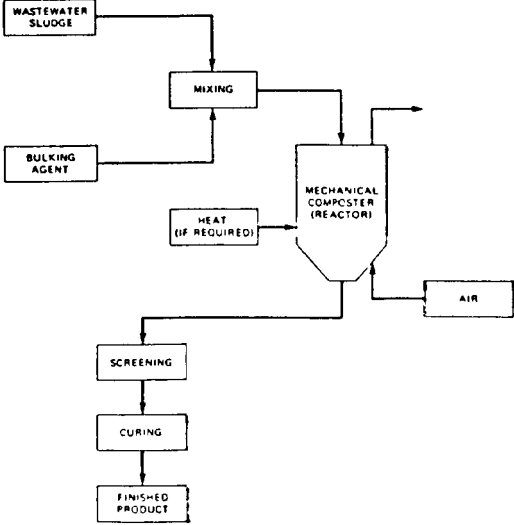

c. Typical in-vessel composting operation.

Figure 4-20. Typical Composting Systems

(3) Composting has recently been suggested for use in treatment of hazardous solid wastes. These include contaminated soils and sediments as well as hazardous solid waste from process industries.

d. Advantages/Disadvantages. The advantages/disadvantages of composting are summarized below:

<u>Advantages</u>	<u>Disadvantages</u>
No dewatering required	Treatment levels may be insufficient
Not energy intensive	Odors may present problems
Product may be agriculturally beneficial	Volume increase possible based on amendment requirements
Low capital investment for similar systems	Operation requires experienced personnel
Existing systems demonstrate reliability	

e. Data Requirements.

(1) Principal data requirements for the design of a compost system are very much dependent on the type of operation, either sewage sludge treatment, municipal/process waste treatment, or hazardous waste treatment. The difference comes in the objectives to be obtained. Some parameters required for all types include:

- (a) Throughput (for sizing).
- (b) Nitrogen and phosphorus levels (as nutrients).
- (c) Bulk density (determines need for bulking).
- (d) Water capacity (determines water requirements).
- (e) Ambient temperatures (insulation).
- (f) C:N ratio (amendment selection).

(2) For sewage sludge, the above should allow design estimates to be made as the compost must be maintained at 55 °C for 3 days. Dewatering and volume reduction of the compost mass can then be evaluated as required.

(3) For municipal/process waste treatment, something should be known about the kinetics of the thermophilic degradation of the particular waste stream. Half-life estimates or rate expressions are used to determine length of time required at the controlled temperature for completion.

(4) For hazardous waste treatment, kinetics of degradation must also be known for design. Contaminant availability in terms of desorption characteristics as well as solubility and vapor pressure become important parameters. If the hazardous waste is volatile at compost temperatures, means to control fugitive emissions must be incorporated.

f. Design Criteria.

(1) Key design parameters for composting include bulk density; carbon to nitrogen ratio (C:N ratio); water content; pile formation and shape; and mixing. Bulk densities of 1000 are considered optimum (this is for the composted material, bulking agent, and amendment mixture). Carbon to nitrogen ratios of 30 to 1 are considered optimum. Phosphorus levels are also important but are not felt to be as much an impact as nitrogen levels. A water content of between 40 and 60 percent may be necessary for good composting. The mixing of the compost matrix and subsequent formation into piles can play a large role in the effectiveness of composting. Bringing the ingredients into intimate contact within the solid matrix to allow microbial digestion requires good mixing. Pile design incorporates requirements for aeration and temperature distribution.

(2) Experience plays a large role in compost operations. Often, local recipes are used to construct the compost matrix based on experimentation on site. As composting is typically a longer term process, upsets can often be corrected before system performance degrades substantially.

(3) The pH of the compost material may play a role in operations, however; conflicting reports in the literature concerning the impact of changes in pH make prediction of the effect difficult. Within a range of 6 to 8 there appears to be no problem with pH. Outside this range site-wise determinations would likely have to be made.

(4) The finished compost may have value as an agricultural amendment. Levels of hazardous chemicals and elements play a key role in the final compost products disposal options or retail value.

(5) Selection of the type of system between windrows, static piles, and in-vessel mechanically agitated systems is dependent on many factors. The capital costs increase dramatically from the windrow to the mechanically agitated, in-vessel system. If levels of control are not necessary (including odor control and temperature) then a windrow system would be applicable. The capital cost of the mechanical system should be carefully weighed against the need for this level of process control. Insufficient data on increased reaction rates in these systems make selection difficult. If possible, pilot scale tests of the wastes to be composted should be conducted prior to selecting this form of composting system.

(6) Most compost systems do not require a large amount of specialized equipment. The backhoe and shovel appear as the most frequent equipment item necessary to conduct operations. Solids handling equipment to include conveyors are often used to increase throughput.

4-19. Encapsulation.

a. Process Description.

(1) Encapsulation is the process by which hazardous wastes are physically enclosed by a synthetic encasement to facilitate environmentally sound transport, storage, and disposal of the wastes. As a remedial action, encapsulation may be used to seal particularly toxic or corrosive hazardous wastes that have been removed from disposal sites. Encapsulation processes can be divided into two categories- thermoplastic microencapsulation, and macroencapsulation (jacketing systems).

(2) Thermoplastic microencapsulation has been successfully employed in nuclear waste disposal and can be adapted to special hazardous wastes. The technique for isolating the waste involves drying and dispersing the material through a heated, plastic matrix. The mixture is then permitted to cool to form a rigid but deformable solid. In most cases it is necessary to use a container such as a fiber or metal drum to give the material a convenient shape for transport. The most common medium for waste incorporation is asphalt; but other materials such as polyethylene, polypropylene, wax, or elemental sulfur have been tried.

(3) Macroencapsulation systems contain potential pollutants by bonding an inert coating or jacket around a mass of cemented waste. This type of waste stabilization is unusual because the jacket or coating of the outside of the waste block is primarily responsible for isolating the waste from its surroundings.

b. Applications.

(1) Waste types that may require encapsulation include the following:

(a) Solid hazardous wastes in bulk or particulate form (e.g., severely contaminated sediments).

(b) Dewatered hazardous sludges.

(c) Containerized hazardous wastes (solids, sludge, or liquid) in damaged or corroded drums.

(d) Hazardous wastes which have been stabilized through solidification/cementation.

(2) TRW Systems Group has successfully developed bench-scale processes to agglomerate and encapsulate toxic and corrosive heavy metal sludges and soluble heavy metal salts, and to encapsulate containerized wastes. The agglomeration/encapsulation process involves mixing dried sludges (containing such hazardous heavy metals as arsenic, lead, mercury, selenium, beryllium, cadmium, zinc, and chromium) with a binder resin (modified 1,2-polybutadiene) and thermosetting the mixture in a special mold, while applying moderate mechanical pressure. The agglomerated material is a hard, tough, solid block. Encapsulating the waste/binder agglomerate with a 1/4-inch seamless jacket of

high density polyethylene (HDPE) is accomplished by packing powdered polyethylene around the block and then fusing the powder in situ with a second metal sleeve mold. A schematic diagram of the apparatus used to encapsulate the agglomerate is shown in Figure 4-21. A commercial-scale encapsulate produced by this method is expected to be a solid cube, 2 feet on edge, weighing 800 to 1,000 pounds. It would require approximately 8 percent (by weight) of polybutadiene resin for its fabrication. Additional jacket sizes will be available in the future.

(3) The second TRW macroencapsulation process is designed to enclose and seal waste containers such as 55-gallon drums (subject to corrosion rupture, leaks, and spills) using the same basic mold and fusion apparatus. To provide load-bearing ability, a 1/8-inch-thick interior casing of fiberglass is used to reinforce the 1/4-inch-thick HDPE jacket that encapsulates the container. A commercial-scale, fiberglass-reinforced HDPE encapsulate is envisioned to provide up to 284 l (75 gallons) of capacity. The cylindrical jacket and casing would comprise about 5.3 percent (by volume) of the total encapsulate volume. Commercially, 7 mm (1/4-inch-thick) HDPE jackets can be fabricated in 30 seconds.

(4) Comprehensive laboratory testing of bench-scale encapsulates has demonstrated their ability to withstand severe mechanical stresses and biological and chemical degradation. Encapsulates containing wastes of various solubility were exposed to leaching solutions of various corrosivity; results indicate that the encapsulated wastes were completely isolated from, and resistant to, simulated disposal environment stresses. The encapsulates were also found extremely resistant to mechanical deformation and rupture. They exhibit high compressive strength and outstanding ability to withstand impact, puncture, and freeze-thaw stresses.

c. Advantages/Disadvantages. The major advantage of encapsulation processes is that the waste material is completely isolated from leaching solutions, and soluble hazardous materials such as heavy metal ions and toxic salts can be successfully encapsulated. The impervious HDPE jacket eliminates all leaching into contacting water (which may infiltrate or flow over disposal sites) and effectively contains hazardous waste substances that might otherwise migrate offsite. The advantages and disadvantages of encapsulation processes are as follows:

<u>Advantages</u>	<u>Disadvantages</u>
Cubic and cylindrical encapsulates allow for efficient space utilization during transport, storage, and disposal	Binding resins required for agglomeration/encapsulation (polybutadiene) are expensive
Hazard of accidental spills during transport is eliminated	Requires large expenditures of energy in fusing the binder and forming the jacket

(Continued)

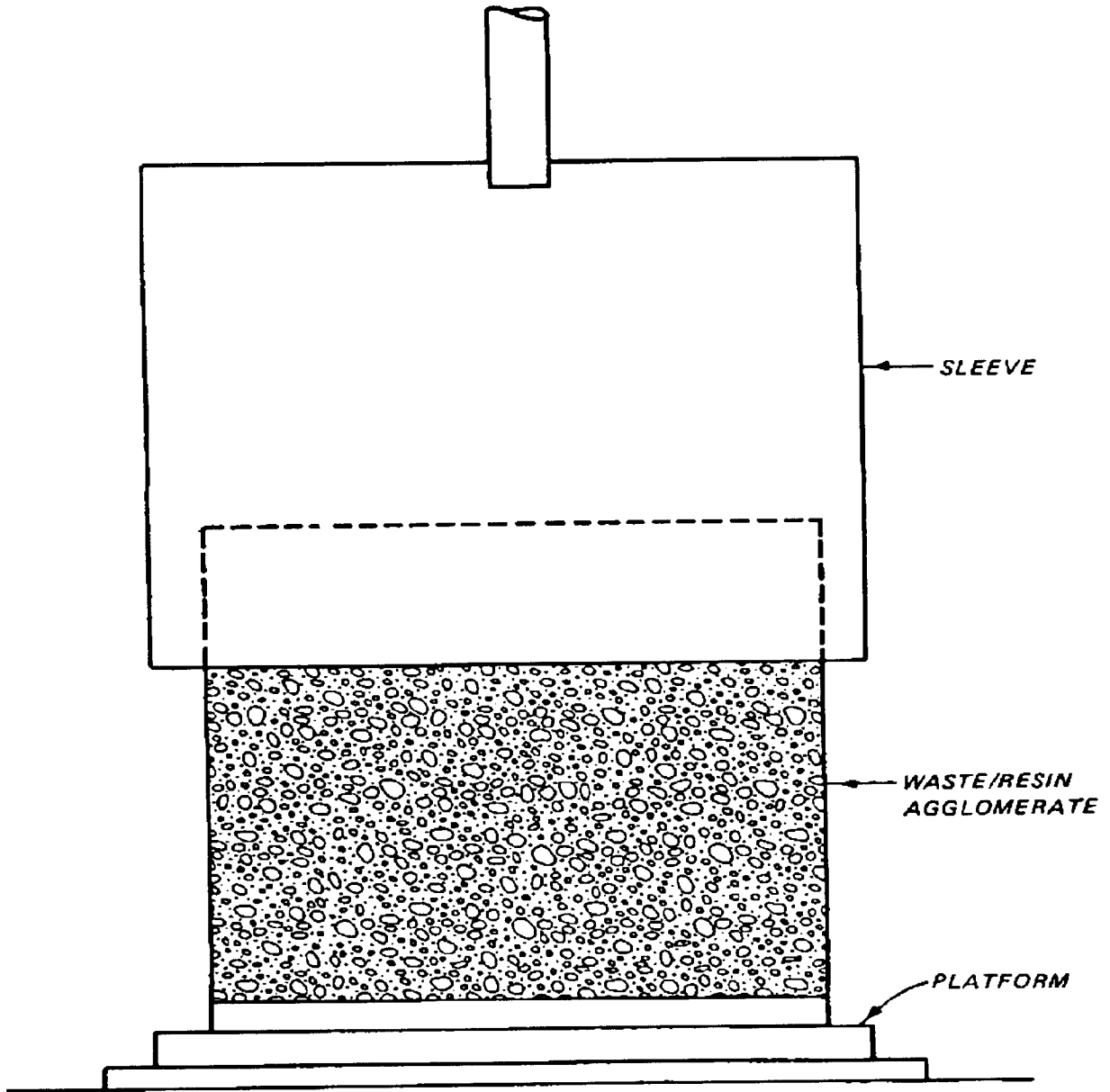

Figure 4-21. Encapsulation Process Concept
(Source: Lubowitz et al. 1977)

<u>Advantages</u>	<u>Disadvantages</u>
HDPE is low in cost, commercially available, very stable chemically, nonbiodegradable, mechanically tough, and flexible	Requires large capital investments in equipment
Encapsulated waste materials can withstand the mechanical and chemical stresses of a wide range of disposal schemes (e.g., landfill, ocean disposal)	Skilled labor is required to operate molding and fusing equipment
	Drying/dewatering of noncontainerized waste sludges is required for agglomeration/encapsulation
	Process has yet to be applied on a commercial scale under actual field conditions

d. Data Requirements. Data requirements are similar to those required for solidification/stabilization described in paragraph 4-21.

e. Design Criteria.

(1) It is important to emphasize that encapsulation techniques have only recently advanced from the developmental and testing stages, and no large commercial-scale encapsulation facilities have been designed and operated as yet. It is likely that, as a remedial action, encapsulation will not be an economically feasible alternative compared to other direct waste treatment methods. However, a central solidification/encapsulating waste processing facility may be technically and economically feasible as a predisposal operation at hazardous waste storage and disposal facilities in the near future.

(2) The fabrication of commercial-scale encapsulates of containerized wastes under actual field conditions would require an encapsulation unit that is readily transportable to the storage or disposal site where containerized wastes reside. Where containerized wastes are of volumes smaller than the design capacity of the encapsulation unit, sand or soil may be used to fill voids between the container and encapsulate walls. Where very large volume waste containers require encapsulation (greater than 208 l (55 gallons)), it may be necessary to install compaction operations at the site.

4-20. Low Temperature Thermal Desorption.

a. Process Description.

(1) Low temperature thermal treatment is a process of heating contaminated soil only enough to vaporize volatile organic compounds (VOCs). The gases emitted from the soil are then treated by a subsequent unit operation. The process described here as an example (Patent No. 4,738,206) uses indirect heat to separate the VOCs from the soil and incineration to destroy the VOCs in the gas phase. Maximum soil temperature for this process is 150 °C. The process was developed by the U.S. Army Environmental Center to treat soils at

military installations contaminated with trichloroethylene, dichloroethylene, tetrachloroethylene, xylene, and other components of solvents and petroleum fuels.

(2) The thermal processor for this system is a Holo-Flite screw conveyor heated by Dowtherm HT hot oil circulating through the shaft, blades, and jacket of the conveyor. A schematic diagram of the system is illustrated in Figure 4-22. Larger scale models may include two thermal processors operated in series with the first processor mounted on top of the second. Maximum temperature for the oil is 350 °C.

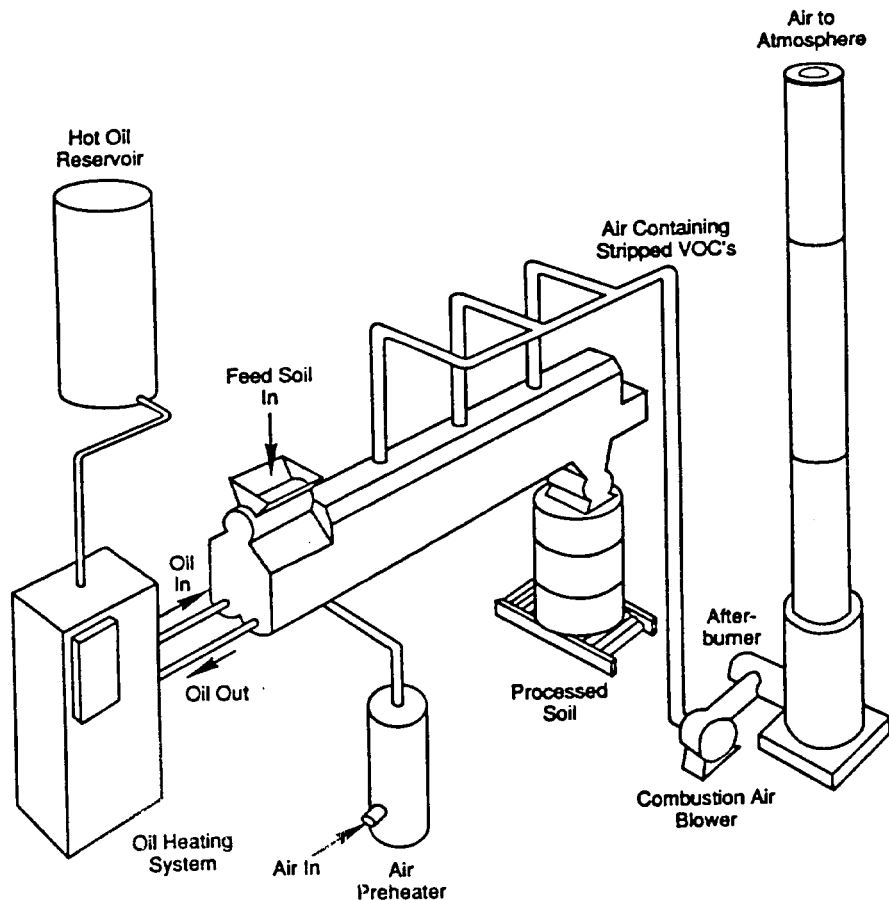

Figure 4-22. Schematic Diagram of a Low Temperature Thermal Treatment System

(3) The vapor stream from the thermal processor consists of the contaminants being removed, water vapor from the soil, and exhaust gases from the hot oil heater. This stream exits at approximately 150 °C (maximum) and flows through a fabric filter, condenser, afterburner, and caustic scrubber system. The fabric filter removes particulate carried over from the processor. The vapor stream then passes through an air-cooled condenser which reduces the temperature to approximately 52 °C. Water and organics condensed reduce the load on the afterburner. The afterburner is a gas-fired, vertical, fume incinerator operating at 980 °C. The afterburner is operated at a minimum of 3 percent excess oxygen. Exhaust from the afterburner is quenched

to approximately 80 °C. It then passes through a packed bed absorber where acid gases produced in the afterburner are neutralized with a caustic solution.

(4) A liquid stream is produced by the condenser which is water rich but does contain some hydrocarbons. The aqueous phase is separated from the organic phase in an oil-water separator. The aqueous phase is processed through a water treatment system consisting of fabric filters followed by granular activated carbon. This water is then used as makeup water for the scrubber and for dust control on processed soil. The organic phase from the separator may be either drummed for off-site disposal or injected into the afterburner.

(5) A system capable of processing 10 metric tons of soil per hour is mobile and can be transported to a site and assembled. Utilities required for operation are propane or natural gas, electricity, and process water. Discharges from the system include the scrubber stack exhaust, the processed soil, the granular activated carbon, and filter cake, and the organic phase from the water separator. Operation requires eight persons for continuous operation, including a site manager and an instrumentation technician.

b. Applications. Low temperature thermal treatment is capable of remediating soils contaminated with volatile and semivolatile compounds. Greater than 99 percent removal from soils has been demonstrated for trichloroethylene, dichloroethylene, and tetrachloroethylene, 1, 2-dichlorobenzene, 1,3-dichlorobenzene, 1,4-dichlorobenzene, toluene, naphthalene, and xylene. It has potential for application to a number of other volatile and semivolatile organic contaminants in soil.

c. Advantages and Disadvantages. Advantages of low temperature thermal treatment are summarized below:

<u>Advantages</u>	<u>Disadvantages</u>
Fully mobile system for on-site treatment	Limited applicability to higher boiling point organic compounds such as PCBs
Indirect heating provides greater thermal efficiency and reduced emission control requirements	Increased moisture content of soil increases costs
Afterburner destroys contaminants	Particle size reduction and debris removal may be required

d. Data Requirements. Design experience for application of this process to a wide range of soil types and contaminants is limited because of its recent development. Laboratory testing to determine optimum temperatures and retention times for the thermal processor should be conducted to develop the process design for the system. Important soil characteristics are grain size, moisture content, and contaminant concentrations.

4-21. Solidification/Stabilization.

a. Process Description.

(1) Solidification/stabilization technology as applied to wastes uses physical and chemical processes to produce chemically stable solids with improved contaminant containment and handling characteristics (Figure 4-23). Waste solidification is the term used to describe the process of sorbing a liquid or semiliquid waste onto a solid medium, such as fly ash, cement, kiln dust, or clay, or otherwise incorporating the waste in a solid matrix. This partial treatment eliminates any free liquid and reduces the risk of spillage or escape of contaminants in any liquid phase.

(2) Solidification may involve the addition of cementing agents so that the solid material (with the sorbed liquid) can be formed into a free-standing impermeable monolith. This part of the waste treatment process reduces the surface area across which transfer or loss of pollutants can occur. Stabilization of waste refers to chemical alteration of the waste so as to reduce the potential for escape of contaminants or to lower the toxicity of specific waste components. Both solidification and chemical stabilization result in transformation of liquid or semisolid wastes to an environmentally safer form. For example, metal-rich sludge would be considered solidified if it were mixed with a dry absorber such as fly ash or dry soil. The benefits of solidification could be carried further if the sorbent and waste were cemented into a permeable, monolithic block. The waste would be considered chemically stabilized if the chemical composition of the sludge were altered by the addition of lime ($\text{Ca}(\text{OH})_2$) to raise the pH so that the potential contaminants (toxic metals) were less soluble and hence less easily leached. An absorbing medium can be formulated to take up free liquid and maintain conditions of lowered solubility for the potential contaminants. Cementing agents (organic polymers, pozzolanic materials, or portland cement) can be added to bind the stable, solid waste into a free-standing, relatively impermeable monolith that represents a substantially reduced environmental threat.

(3) Waste solidification/stabilization systems that have potentially useful application in remedial action activities discussed in this paragraph are: sorption, lime-fly ash pozzolan, and pozzolan-portland cement systems. Encapsulation processes such as thermoplastic microencapsulation and macroencapsulation were addressed in paragraph 4-19.

(a) Sorption. Most waste materials considered for solidification/stabilization are liquids or sludges (semisolids). In order to prevent the loss of drainable liquid and improve the handling characteristics of the waste, a dry, solid sorbent is generally added to the waste. The sorbent may interact chemically with waste or may simply be wetted by the liquid part of the waste (usually water) and retain the liquid as part of the capillary liquid. The most common sorbents used with waste include soil and waste products such as bottom ash, fly ash, or kiln dust from cement manufacture.

STABILIZATION

TREATMENT TO REDUCE SOLUBILITY

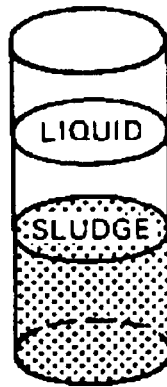

← EX. pH ADJUSTMENT, CHEMICAL OXIDATION, OR REDUCTION

SOLIDIFICATION

SORPTION TO PRODUCE A SOLID WITH NO FREE LIQUID



← EX. MIXING WITH FLY ASH OR CLAY SORBENTS

FORMATION OF MONOLITH WITH REDUCED SURFACE AREA

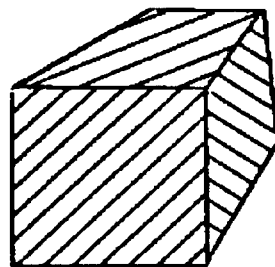

← EX. ADDITION OF PORTLAND CEMENT (MAY BE ADDED ALONG WITH SORBENTS)

Figure 4-23. Steps in Stabilization/Solidification of Hazardous Wastes

In general, selection of sorbent materials involves tradeoffs between chemical effects, costs, and amounts required to produce a solid product suitable for burial. Table 4-18 summarizes chemical binding properties of natural sorbents for selected waste leach liquids. Where the ability of a sorbent to bind particular contaminants is important to containment, sorbents with specific chemical affinities can be selected. The pH of the waste strongly affects sorption/waste interactions, and pH control is an important part of any sorption process.

Table 4-18. Natural Sorbents and their Capacity for Removal of Specific Contaminants from Liquid Phases of Neutral, Basic, and Acidic Wastes

<u>Contaminant</u>	<u>Neutral waste (calcium fluoride)</u>		<u>Basic waste (metal finishing sludge)</u>		<u>Acidic waste (petroleum sludge)</u>	
Ca	Zeolite	(5054)*	Illite	(1280)	Zeolite	(1390)
	Kaolinite	(857)	Zeolite	(1240)	Illite	(721)
			Kaolinite	(733)	Kaolinite	(10.5)
Cu	Zeolite	(8.2)	Zeolite	(85)	Zeolite	(5.2)
	Kaolinite	(6.7)	Kaolinite	(24)	Acidic F.A.	(2.4)
	Acidic F.A.**	(2.1)	Acidic F.A.	(13)	Kaolinite	(0)
Mg	Basic F.A.	(155)	Zeolite	(1328)	Zeolite	(746)
			Illite	(1122)	Illite	(110)
			Basic F.A.	(176)	Basic F.A.	(1.7)
Zn					Zeolite	(10.8)
					Vermiculite	(4.5)
					Basic F.A.	(1.7)
Ni			Zeolite	(13.5)		
			Illite	(5.1)		
			Acidic F.A.	(3.8)		
F	Illite	(175)	Kaolinite	(2.6)	Illite	(9.3)
	Kaolinite	(132)	Illite	(2.2)	Acidic F.A.	(8.7)
	Acidic F.A.	(102)			Kaolinite	(3.5)
Total CN					Illite	(12.1)
					Vermiculite	(7.6)
					Acidic F.A.	(2.7)
COD	Acidic F.A.	(690)	Illite	(1744)	Vermiculite	(6654)
	Illite	(180)	Acidic F.A.	(1080)	Illite	(4807)
			Vermiculite	(244)	Acidic F.A.	(3818)

* Values represent sorbent capacity in micrograms of contaminant removed per gram of sorbent used.

** F. A. = fly ash. Acidic F.A. = Class F; Basic F.A. = Class C.

(b) Lime-fly ash pozzolan. Solidification/stabilization of waste using lime and pozzolanic material requires that the waste be mixed with a carefully selected, reactive fly ash (or other pozzolanic material) to a pasty consistency. Lime (calcium hydroxide) is blended into the waste-fly ash mixture. Typically 20 to 30 percent lime is needed to produce a strong pozzolan. The resulting moist material is packed or compressed into a mold to cure or is placed in the landfill and compacted.

(c) Pozzolan-portland cement. There are a wide variety of treatment processes that incorporate portland cement as a binding agent. Pozzolan products (materials with fine-grained, noncrystalline, reactive silica) are frequently added to portland cement to react with any free calcium hydroxide and thus improve the strength and chemical resistance of the concrete-like product. In waste solidification, the pozzolan materials (such as fly ash) are often used as sorbents. Much of the pozzolan in waste processing may be waste coated and relatively unreactive. Any reaction that does occur between the portland cement and free silica from the pozzolan adds to the product strength and durability. Waste solidifying formulations based on portland and pozzolan-portland systems vary widely, and a variety of materials have been added to change performance characteristics. These include soluble silicates, hydrated silica gels, and clays such as, bentonite, illite, or attapulgite. Approximate reagent requirements for some example applications are given in Table 4-19.

Table 4-19. Approximate Reagent Requirements for Various Waste Types Using a Portland Cement/Fly Ash Solidification¹

Waste	Kilograms of reagent per liter of waste
Spent brine	3.8
Metal hydroxide sludge	2.4
Copper pickle liquor sludge	1.9
FeCl ₂ pickle liquor sludge (1.5 percent HCl)	3.5
Sulfuric acid plating waste (15 percent (H ₂ SO ₄))	3.8
Oily metal sludge	0.96

¹After Stanczyk, Senefelder, and Clarke (1982). The proportion of portland cement to fly ash was not given.

b. Applications.

(1) Most large, hazardous waste landfills are currently employing sorption to satisfy requirements prohibiting burial of liquids. Nineteen million liters (five million gallons) of oil sludge from a former refinery site was landfilled onsite after treatment with cement kiln dust. The process required 3.71×10^7 kg (40,939 tons) of kiln dust.

(2) Lime-fly ash solidification/stabilization systems have been successfully used in managing hazardous waste, but generally the containment performance is such that a hazardous waste after processing would still be classed as hazardous. Lime-fly-ash-pozzolan-based landfills have been established using liner and monitoring systems to ensure safe disposal. There have been cases where lead wastes were judged nonhazardous after treatment, but in most cases a pozzolan-treated waste is not delisted.

(3) Pozzolan-portland-cement-based systems are among the most versatile. They can neutralize and seal acids and can handle strong oxidizers such as chlorates and nitrates. These methods are also good for solidifying many toxic metals, since at the pH of the cement (pH 9-11), many metals are insoluble carbonates and hydroxides.

c. Advantages/Disadvantages.

(1) Sorption has been widely used to eliminate free water and improve handling. Some sorbents have been employed to limit the escape of volatile organic compounds. Sorbents may also be useful in waste containment when they modify the chemical environment and maintain the pH and redox potential to limit the solubility of the waste. Although sorption eliminates the bulk flow of wastes from the site, in many cases leaching of waste constituents from the sorbent can be a significant source of pollution.

(2) The major advantages of the lime-fly ash solidification/stabilization technique include the ready availability and low cost of materials, and the familiarity of commonly used equipment. A disadvantage is that the solid mass resulting from lime-based solidification is porous. As such, it must either be sealed or placed in a secure landfill to prevent leaching of contained wastes. Another major disadvantage is that sludge or wastes containing organics cannot be treated.

(3) Provided pozzolan-portland cement based systems are used on compatible wastes, the short-term effectiveness can be expected to be quite good. The equipment for cement mixing is commonplace and the process is quite tolerant of chemical variations. However, because cement is a porous solid, contaminants can be leached out of the matrix over time and, therefore, these systems are usually not effective for organic wastes. Although it is possible to seal the outside of a block of cement-solidified wastes using styrene, vinyl, or asphalt to prevent leaching, no commercial systems are available to do this.

d. Data Requirements. The principal data requirements for solidification/stabilization techniques include:

(1) Waste characteristics (binding agent selection).

(a) pH.

(b) Buffer capacity.

(c) Water content.

(d) Total organic carbon.

(e) Inorganic and organic constituents.

(2) Treatability tests (cure time, mix).

(a) Leachability.

(b) Strength.

e. Design Criteria. The key design parameters for solidification/stabilization techniques include:

(1) Solidification mixing ratios.

(2) Curing time.

(3) Volume increase of solidified product.

f. Evaluation. The evaluation of these factors is dependent on the solidification technology and the specific waste being treated.

4-22. Thermal Destruction.

a. Process Description. Incineration combusts or oxidizes organic material at very high temperatures. The end products of complete incineration are CO₂, H₂O, SO₂, NO₁, and HCl gases. Emission control equipment (scrubbers, electrostatic precipitators) for particulates, SO₂, NO_x, and products of incomplete oxidation are needed to control emissions of regulated air pollutants. Common types of incinerators most applicable to hazardous waste include:

(1) Rotary kilns.

(2) Multiple hearth.

(3) Fluidized bed.

(4) Liquid injection.

The key features of incineration methods cited previously are summarized in Table 4-20.

Table 4-20. Key Features of Major Types of Incinerators

Type	Process principle	Application	Combustion temp.	Residence time
Rotary kiln	Slowly rotating cylinder mounted at slight incline to horizontal. Tumbling action improves efficiency of combustion	Most organic wastes; well suited for solids and sludges; liquids and gases	810-1,640 °C (1,500-3,000 °F)	Several seconds to several hours
Multiple hearth	Solid feed slowly moves through vertically stacked hearths; gases and liquids feed through side ports and nozzles	Most organic wastes, largely in sewage sludge; well suited for solids and sludges; also handles liquids and gases	760-980 °C (1,400-1,800 °F)	Up to several hours
Liquid injection	Vertical or horizontal vessels; wastes atomized through nozzles to increase rate of vaporization	Limited to pumpable liquids and slurries (750 SSU Saybolt Seconds Universal) or less for proper atomization)	650-1,650 °C (1,200-3,000 °F)	0.1 to 1 sec
Fluidized bed	Wastes are injected into a hot agitated bed of inert granular particles; heat is transferred between the bed material and the water during combustion	Most organic wastes; ideal for liquids, also handles solids and gases	750-870 °C (1,400-1,600 °F)	Seconds for gases and liquids; longer for solids

b. Applications.

(1) Incineration is used for reduction of sludge volume, thereby reducing land requirements for disposal. Incineration can also be used to destroy most organic wastes whether they be gas, liquid, or solid.

(2) Mobile incineration systems have been considered for onsite treatment at hazardous waste sites. The EPA's Office of Research and Development has completed construction and is in the testing phase of a mobile incineration system. The system was designed to EPA's PCB destruction specifications to provide state-of-the-art thermal detoxification of long-lived, refractory organic compounds, as well as debris from cleanup operations. Hazardous substances that could be incinerated include compounds containing chlorine and phosphorous--for example, PCB's, kepone, dioxins, and organophosphate pesticides, which may be in pure form, in sludges, or in soils. A typical mobile incinerator is illustrated in Figure 4-24.

c. Advantages/Disadvantages. The advantages and disadvantages of hazardous waste treatment with incineration are summarized below:

<u>Advantages</u>	<u>Disadvantages</u>
Can destroy a wide range of organic wastes	Thickening and dewatering pretreatment may be required
Can handle gaseous, liquid, and solid wastes	May not be economical for small plants
	Air pollution control measures are required

d. Data Requirements. The principal data requirements for the design of an incineration system are:

- (1) Waste constituents and characteristics.
 - (a) Moisture content.
 - (b) Volatile materials content.
 - (c) Ash content.
 - (d) Ash specific level, specific gravity, or bulk density.
 - (e) Ash particle size range.
 - (f) Carbon, hydrogen, oxygen, halide, sulfur, nitrogen, phosphorus content.
 - (g) Waste specific gravity, viscosity, and melting point.

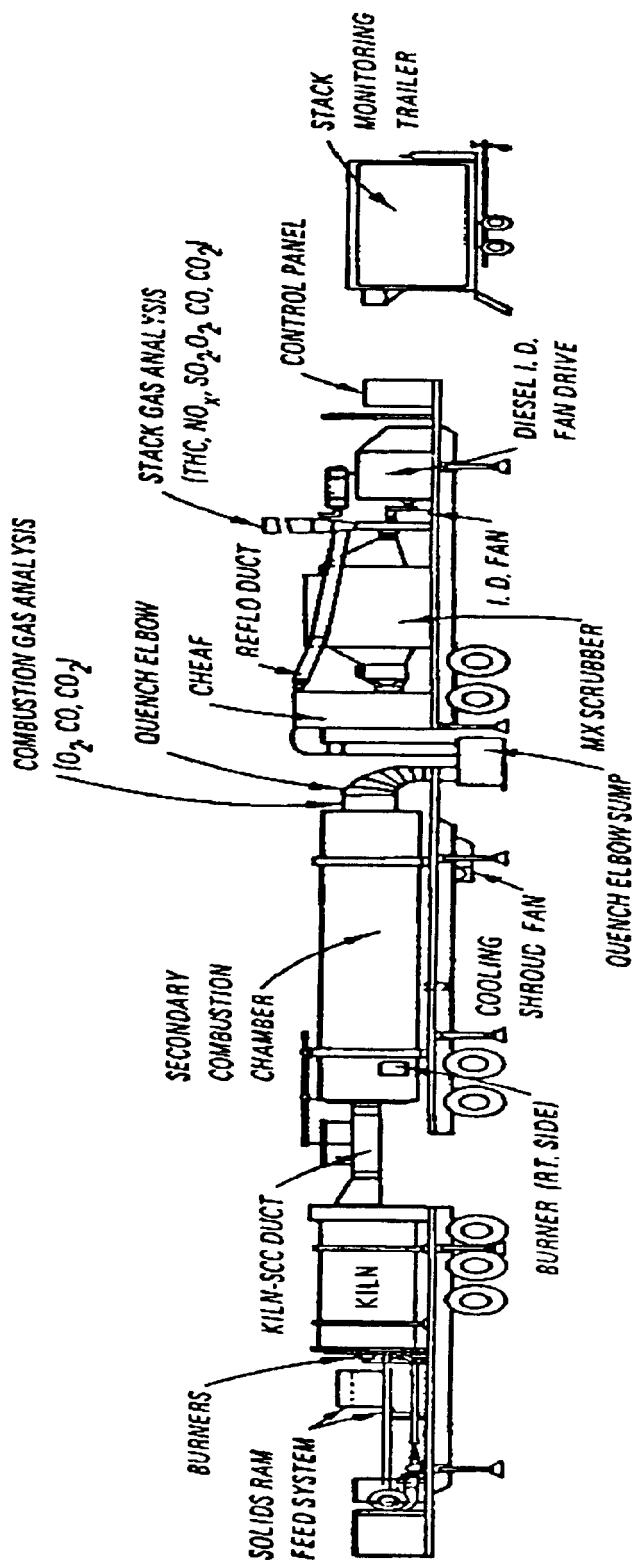

Figure 4-24. EPA Mobile Incineration System

- (h) Metal content.
- (i) Thermogravimetric analysis.
- (j) Suspended and dissolved solids.
- (k) Reactive chemical groups.
- (l) Flammability, stability, detonation.
- (m) Environmental sensitivity.
- (n) Toxicity.
- (2) Process characterization.
 - (a) Residence time.
 - (b) Temperature.
 - (c) Destruction efficiencies.
 - (d) Ash residue.
 - (e) Gaseous effluent.

e. Design Criteria. The design criteria for a fluidized bed furnace (FBF) and a multiple hearth furnace (MHF) are presented in Tables 4-21 and 4-22, respectively. During actual operations some extensive maintenance problems have occurred with air preheaters. Venture scrubbers have also had scaling problems. Screw feeds and screw pump feeds are both subject to jamming because of either overdrying of the sludge feed at the incinerator or because of silt carried into the feed system with the sludge. Fluidized bed furnace systems have had problems with the burnout of spray nozzles or thermo-couples in the bed.

Table 4-21. Design Criteria for Fluidized Bed Furnace

Parameter	Design criteria
Bed loading rate	245 to 294 kg/m ² /hr (50 to 60 lb wet solids/ft ² /hr)
Superficial bed velocity	0.12 to 0.18 m/s (0.4 to 0.6 ft/sec)
Sand effective size	0.2 to 0.3 mm (uniformity coefficient = 1.8)
Operating temperature	760 to 816 °C (1,400 to 1,500 °F) (normal); 1204 °C (2,200 °F) (maximum)
Bed expansion	80 to 100 percent
Sand loss	5 percent of bed volume per 300 hr of operation

Table 4-22. Design Criteria for Multiple Hearth Furnace

Parameter	Design criteria
Maximum operating temperature	927 °C (1,700 °F)
Hearth loading rate	29.4 to 49 kg/m ² /hr ((6 to 10 lb wet solids/ft ² /hr) with a dry solids concentration of 20-40 percent
Combustion airflow	12 to 13 kg/kg dry (12 to 13 lb/lb dry solids)
Shaft cooling airflow	1/3 to 1/2 of combustion airflow
Excess air	75 to 100 percent

4-23. Volume Reduction.

a. Process Description.

(1) Volume reduction as applied to sludges can be termed as thickening or dewatering processes. Thickening of sludge consists of the removal of supernatant, thereby reducing the volume of sludge that will require disposal or treatment. Gravity thickening takes advantage of the difference in specific gravity between the solids and water.

(2) Centrifuges are used to dewater sludges using centrifugal force to increase the sedimentation rate of sludge solids. During the process of centrifugation, if a particle is more dense than the fluid, it will tend to migrate in the direction of the centrifugal force, i.e., toward the periphery of the rotating vessel containing the fluid. If the particle is less dense than the fluid, there will be a tendency for the particle to remain near the center of rotation and the fluid to migrate toward the periphery of the vessel. Either way, particles that were uniformly dispersed throughout the fluid prior to centrifugation would now be concentrated in a specific region of the centrifuge where they can be removed as a more concentrated mixture. In centrifugation, the centrifugal force is analogous to gravitational force in the sedimentation process. In centrifugation, however, forces equal to several thousand times the force of gravity are often generated.

(3) Volume reduction will frequently be required to meet regulatory restraints as applied to disposal of hazardous waste. Disposal costs can be reduced through the use of volume reduction techniques by eliminating nonhazardous free liquids from a waste. Before a hazardous waste can be disposed of at a chemical waste landfill, it must be solidified. Typically the solidification process will add to the total weight and volume and therefore the disposal costs. If the same waste can be separated into a reduced volume of hazardous solid waste and a nonhazardous liquid waste, disposal costs can be lowered significantly.

b. Applications. Dewatering and thickening processes have been used primarily to thicken primary, secondary, and digested sludges. Centrifuges may be used for thickening sludges where space limitations or sludge characteristics make other methods unsuitable. However, if a particular sludge can be effectively thickened by gravity without chemicals, centrifuge thickening is not economically feasible. Centrifuges are generally used for dewatering sludge in larger applications where sludge incineration is required.

c. Advantages/Disadvantages. Gravity thickening is highly dependent on the dewaterability of the sludges being treated while centrifugal thickening processes can have significant maintenance and power costs. Adequate electric power must also be provided for the large motors that are required. Depending on the waste, the liquid fraction after centrifugation may be considered hazardous also and require proper disposal. Typically the liquid fraction will be relatively high in suspended nonsettling solids.

d. Data Requirements. The data requirements for gravity thickening or centrifugation include:

- (1) The waste stream daily flow.
- (2) Settling velocity.
- (3) Size distribution.
- (4) Solids specific gravity.
- (5) Liquid specific gravity.

e. Design Criteria.

(1) For gravity thickeners detention times of 1 to 3 days are used, sludge blankets of at least 3 feet are common, side water depths of at least 10 feet are a general practice, and surface loading rates can range from 5 to 25 pounds per day per square foot depending on the sludge type and pretreatment used.

(2) Each installation of a centrifuge is site specific and dependent upon a manufacturer*s product line. Maximum capacities of about 9.1×10^4 kg (100 tons per hour) of dry solids are available in solid-bowl units with diameters up to 1.4 m (54 inches) and power requirements up to 130 KW (175 horsepower). Disk-type units are available with capacities up to 1.5 m³/min (400 gallons per minute) of concentrate.

4-24. Wet Oxidation.

a. Process Description.

(1) Wet air oxidation (WAO) is truly an oxidation process. Thermodynamically, it is similar to chemical oxidation and incineration.

(2) The waste is pumped into the system by the high-pressure pump and mixed with air from the air compressor. The mixture passes through a heat exchanger and then into the reactor where oxygen in the air reacts with organic matter in the waste. This oxidation is accompanied by a temperature rise. The gas and liquid phases are separated after the reactor, and the liquid passes through the heat exchanger heating the incoming material. The gas and liquid streams are discharged from the system through control valves.

(3) As would be expected, the operating temperature is critical. Organic molecules are excited thermally (as opposed to UV light) to a level where a high percentage undergo an oxidation reaction. As expected, various materials require different energy levels for a significant reaction rate to take place. Figure 4-25 shows the relationship between temperature and degree of oxidation for several different materials. At 150 °C, 5 to 10 percent of the COD may be oxidized, whereas at 320 °C, nearly complete oxidation occurs for many substances.

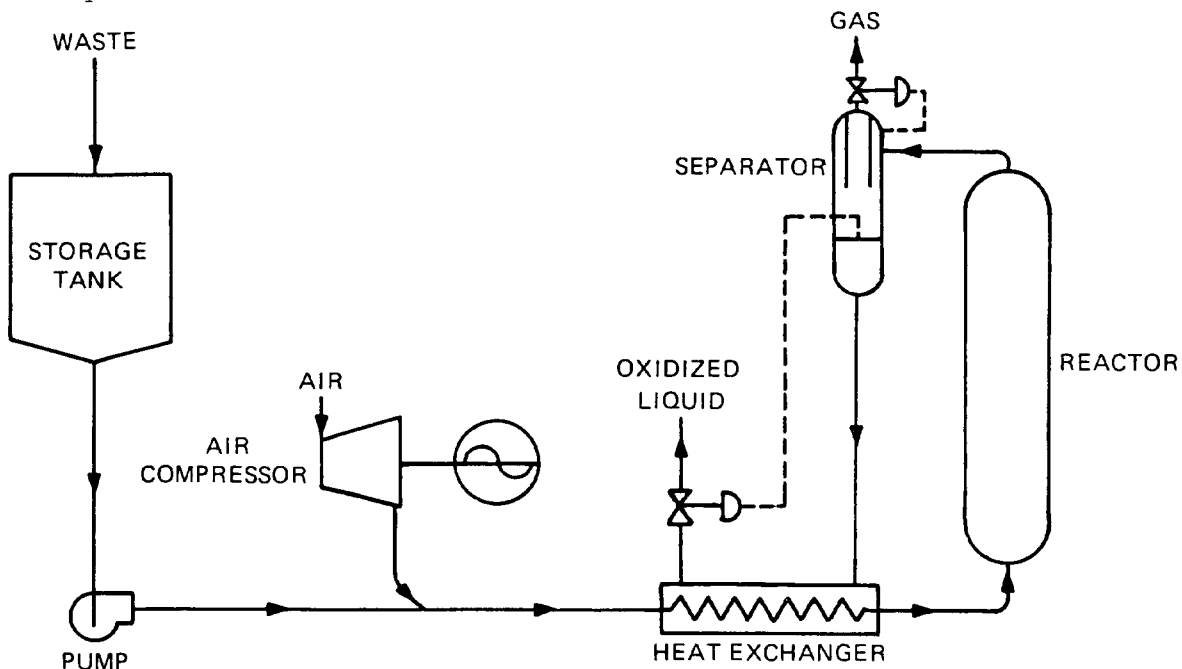

Figure 4-25. Flow Sheet of Wet Air Oxidation

b. Applications.

(1) WAO conditions can be controlled to achieve a desired end product by controlling the temperature and the reaction time. With increased temperature, the degree of oxidation increases as shown in Figure 4-26. As the oxidation condition becomes more severe, more of the nonbiodegradable components of the waste are converted to biodegradable forms. WAO may be used as a treatment to detoxify a waste before biological treatment. This technique has been used to treat acrylonitrile wastewaters that are highly concentrated in cyanide and organic nitrites.

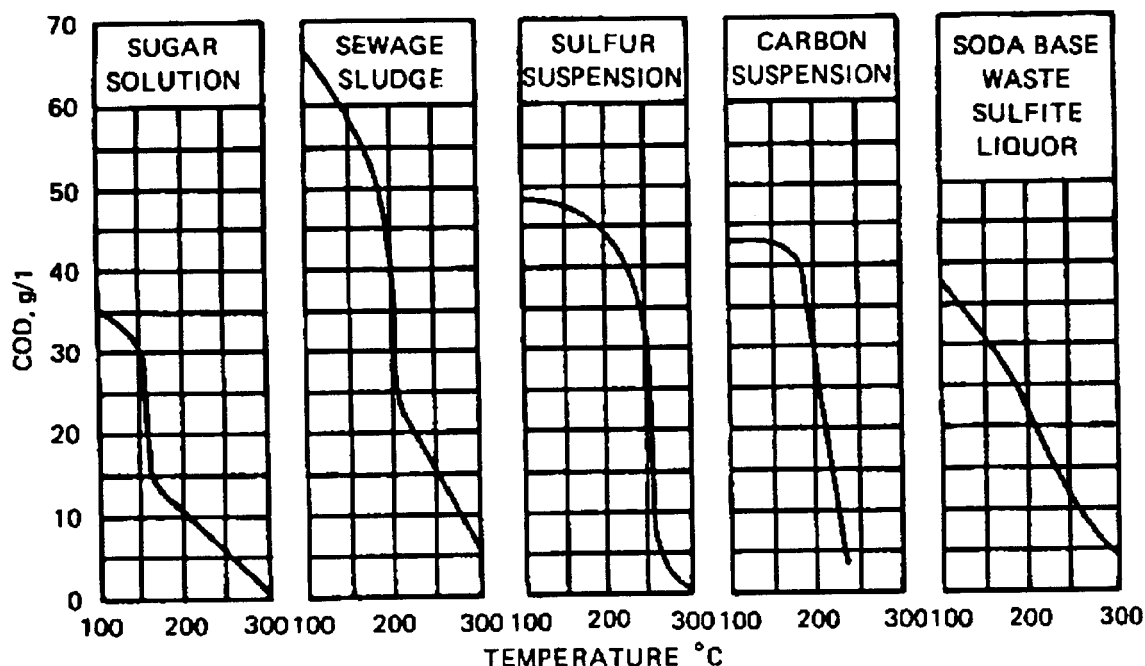

Figure 4-26. Oxidation Curves for Five Aqueous Fuels

(2) WAO may be well suited for treating hazardous waste. Recent studies have focused upon some of the 65 priority pollutants originally proposed by the EPA. Results are shown in Table 4-23. It should be observed that operating conditions were fairly stringent (275 to 320 °C and 6200 to 12,400 KPa (900 to 1800 pounds per square inch) atmosphere (psia)). However, removal percentages are impressive. It is not clear if these reductions represent a conversion to CO₂ or simply a modification to the original molecule. It should be noted that most of the materials in Table 4-23 are aromatic derivatives. In many cases, the toxicity of aromatics is greatly reduced by simply opening the ring structure of the molecules. This would require only fractional oxidation.

c. Advantages/Disadvantages.

(1) WAO is an exciting oxidative process that appears to have wide application along with versatility and flexibility. Almost any combustible materials, organic or inorganic, can be treated by WAO. The question of economics affects selection of this process since it is energy intensive.

(2) Typically WAO should be considered as a step in the overall waste treatment process. It is rarely used as the total treatment. WAO may not be reasonable for waste containing less than 2,000 milligrams per liter COD. Depending upon capital and the nature and treatability of the waste, it may be desirable to treat by another method or to concentrate to reduce the volume prior to WAO treatment.

Table 4-23. Examples of One-Hour Oxidation of Selected Compounds

Compound	Starting Concentration (g/l)	% Starting material destroyed		
		320°C	275°C	275°C/* Cu ⁺⁺
Acenaphthene	7.0	99.96	99.99	-
Acrolein	8.41	99.96	99.05	-
Acrylonitrile	8.06	99.91	99.00	99.50
2-Chlorophenol	12.41	99.86	94.96	99.88
2,4-Dimethylphenol	8.22	99.99	99.99	-
2,4-Dinitrotoluene	10.0	99.88	99.74	-
1,2-Diphenylhydrazine	5.0	99.98	99.98	-
4-Nitrophenol	10.00	99.96	99.60	-
Pentachlorophenol	5.0	99.88	81.96	97.30
Phenol	10.0	99.97	99.77	-

* Cupric sulfate was added as a catalyst.

(3) Primary other advantages and disadvantages are summarized below:

Advantages	Disadvantages
May be controlled to deliver a specific degree of oxidation	Requires operation at high pressure and temperatures
Can be used to detoxify toxic materials	Corrosive inorganics can be a problem at high temperatures
No net heating requirement if the COD is >15,000 mg/l	Initial capital costs are high
	Primarily suited for pretreatment as reductions of 10 to 15% are typical

d. Data Requirements. In general, bench scale and/or pilot scale testing will be required for design. The following parameters should be determined:

- (1) COD of wastes.
- (2) TDS of wastes.
- (3) Operating temperature.
- (4) Retention time.
- (5) Degree of stabilization.
- (6) Degree of detoxification.

e. Design Criteria.

(1) Due to the critical nature of the temperature, the operating system becomes a prime design parameter. Not only will the system require specific design for a specified operating pressure but also the compressor system must be capable of delivering air or oxygen at the maximum operating pressure expected in the system. Table 4-24 presents data on the temperature-pressure relationship of steam.

Table 4-24. Temperature/Pressure Relationship of Saturated Steam

Pressure		Temperature	Temperature
(psia)	(KPa)	(°C)	(°F)
100	689	212	14.7
125	861	257	34
150	1034	302	69
175	1206	347	130
200	1378	392	226
225	1550	437	371
250	1722	482	577
275	1895	527	863
300	2067	572	1248
325	2239	617	1762

(2) As a general rule, the maximum operating temperature will be about 200 °C. Higher temperatures may be reached but at the expense of a large increase in pressure.

(3) If the COD of the waste is less than 15,000 milligrams per liter, consideration should be given to concentrating the waste stream prior to WAO treatment.

4-25. Evaporation.

a. Background.

(1) Evaporation is a technique used for many years in the process industry. It is also used in waste treatment applications. In concept, evaporation is no more complicated than placing a pot on a stove and evaporating the contents. It is not a necessary criterion to carry to dryness.

(2) The objective of evaporation is to reduce the volume of waste to handle by concentrating a solution consisting of a nonvolatile solute and a volatile solvent, In the overwhelming majority of evaporations applicable to

toxic waste sites, the solvent is water. Evaporation is conducted by vaporizing a portion of the solvent to produce a concentrated solution or a thick liquor.

(3) Evaporation differs from drying in that the residue is often a highly viscous liquid, rather than a solid; it differs from distillation in that the vapor is usually a single component, and even when the vapor is a mixture, no attempt is made in the evaporation step to separate the vapor into fractions; it differs from crystallization in that the emphasis is placed on concentrating a solution rather than forming and building crystals. In certain situations, however (for example, in the evaporation of brine to produce salt), the line between evaporation and crystallization is not distinct. Evaporation sometimes produces a slurry of crystals in a saturated mother liquor.

(4) It appears that evaporation will remain a popular unit operation for many years to come even though energy requirements are very significant. As manufacturing facilities push toward zero discharge through various recycling and recovery programs, evaporation will play an important role in closing the loop in many of these operations.

b. Process Description.

(1) There are many types of evaporators currently in use in the industrial scene. The intent here is to introduce only the most likely processes which may be applicable to hazardous waste problems. Evaporator systems may be single or multiple effect. This is analogous to saying they may be single or multiple stages.

(2) Single-effect evaporators are used where the required capacity is small, steam is cheap, the vapors or the liquids are so corrosive that very expensive materials of construction are required, or when the vapor is so contaminated that it cannot be used for steam. Single-effect evaporators may be operated in batch, semibatch, continuous batch, or continuous mode. In any configuration, the single-effect system is the most energy intensive with the least capital expenditure.

(3) Perhaps the most widely used configuration is the multiple-effect scheme. The choice of the number is up to the designer. Most textbooks and references to multiple-effect evaporators will typically show three effects as shown in Figure 4-27. However, a system may theoretically have an infinite number of effects. On the practical side, the number of effects will be limited by a balance between capital cost and operating cost. Vapor from the first effect is used as steam for the second effect and so on. Steam economy of a multiple-effect evaporator will increase in proportion to the number of effects, but will be somewhat less numerically than the number of effects. A system designed for producing pure water from seawater uses a 20-effect system. The steam-to-product ratio is 1 to 19. The increased steam economy is offset by an increase in capital expenditure.

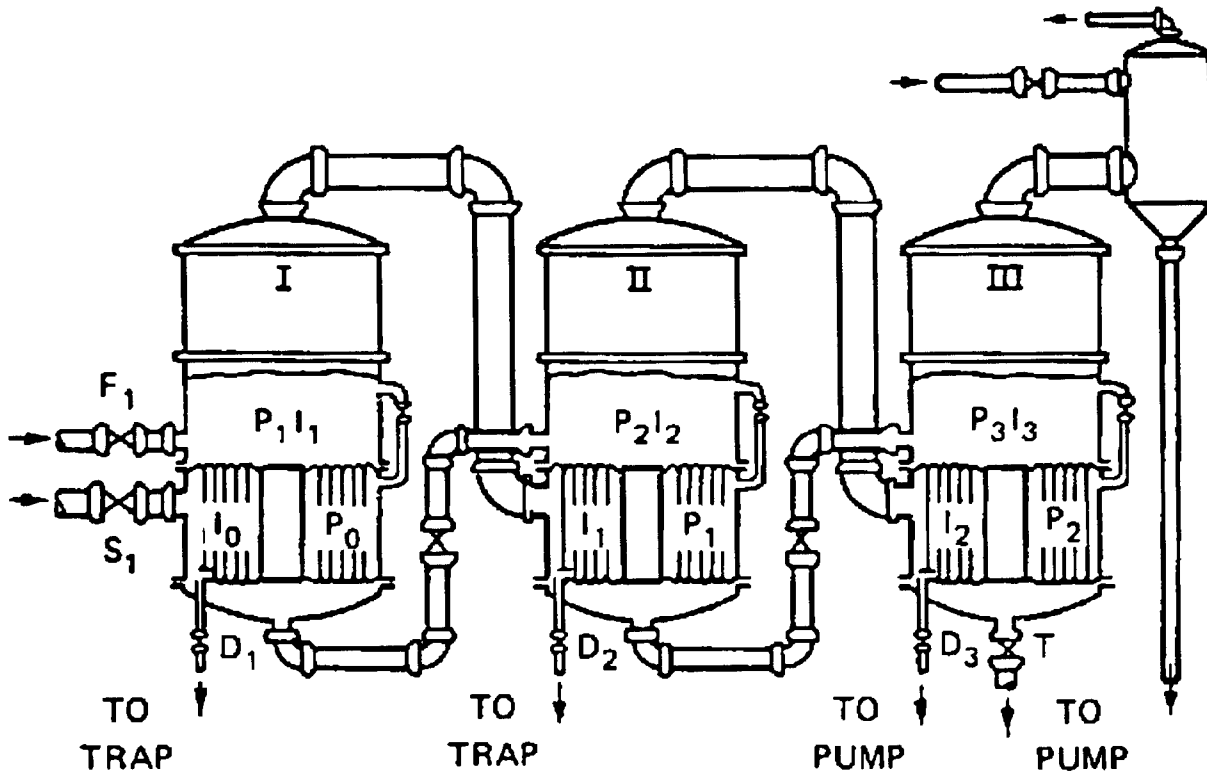

Figure 4-27. Three-Effect Evaporator.

(4) Energy requirements for evaporation will vary widely depending on the number of effects used as indicated above. Also, the heat transfer coefficients for a particular system will influence the energy requirements. The normal operating range of energy for evaporation is 6.45×10^{-2} to 0.71 KW/hr/Kg H₂O (100 to 1,100 BTU*s per pound of water) evaporated. The latter value assumes a single-effect system with little heat recovery.

c. Applications. Evaporation is a well-defined, well-established process that is essentially omnipresent in industry. It is being used currently for the treatment of hazardous waste such as radioactive liquids and sludges, concentrating of plating and paint solvent waste, and in the pulp and paper industry, six-effect evaporators are typically used to concentrate black liquor while producing methanol. It is capable of handling liquids, slurries, and sometimes sludges, both organic and inorganic, containing suspended or dissolved solids or dissolved liquids where one of the components is essentially nonvolatile. It can be used to reduce waste volume prior to incineration or precipitation.

d. Advantages/Disadvantages. A summary of advantages and disadvantages is presented below:

<u>Advantages</u>	<u>Disadvantages</u>
Not a new technology; has been used many years in the chemical process industries	Energy intensive process, offset somewhat by multiple-effect operation
Large volume reductions can be realized	Evaporation tubes are easily fouled, lowering heat transfer coefficients
Effective pretreatment step prior to incineration	Requires a source of steam
Condensate may be marketable	Bottoms and condensate may require further treatment or disposal

e. Data Requirements. Data requirements include:

(1) Thermodynamic data for stream being evaporated, i.e., sensible heat, heat of vaporization over concentration range, heat of crystallization.

(2) Feed flow rate and temperature.

(3) Pressure and/or temperature of available stream.

(4) Vacuum or boiling temperature of the last stage.

(5) Suitability of vapor from first stage as steam for the second stage, etc.

(6) Quality of water to be evaporated, i.e. extent of concentration.

(7) Number of effects or stages to be used.

(8) Heat transfer coefficients as a function of boiling temperature and)t.

f. Design Criteria.

(1) Evaporation systems are generally designed to balance the cost between capital and operating costs. As additional effects are added to a system, the more energy efficient the system becomes. This savings in energy will be at the expense of capital cost. At some point, an optimum number of effects will be realized. The number of effects is also constrained by the available steam pressure for the first stage and the vacuum for the last stage. Still another consideration is the quantity of material to be processed. For very small volumes, a single stage may be sufficient.

(2) For waste treatment applications, the number of effects may be established on the basis of the available quantity and quality of steam along with good engineering judgment. Heating surfaces in all effects of a multiple effect system should be equal to obtain economy of construction. Design procedures are presented in Badger and Banchero (1955) and DeRenzo (1978). Metry (1980) should be consulted for heat transfer considerations.

Section III. In Situ Treatment Technologies

4-26. Biological Treatment.

a. Process Description.

(1) Organic materials in contaminated soils may be amenable to biodegradation in place, or in situ. The process consists largely of producing conditions in the soil mass which promote the rate of natural degradation by endogenous organisms. Conditions favoring biodegradation include increased aeration and nutrient concentrations. In some cases, seed cultures may increase the active population and be beneficial.

(2) The biodegradation process is slow relative to other remedial action technologies. Complete degradation of the waste could take several years and may never be complete if refractory compounds such as polynuclear aromatics are present. This is a major disadvantage, since additional migration of contaminants can occur during the treatment and even afterwards.

(3) This technique is generally limited to those situations where the waste material or contaminated soil is naturally aerated or where artificial aeration is feasible. Procedures for the addition of nutrients such as nitrogen and phosphorus may be necessary if the waste material is deficient in these constituents. Lime may be required to maintain proper pH.

b. Applications.

(1) Situations where in situ bioremediation could be applied are those where complete mixing and/or aeration can be achieved. A primary application is a chemical spill or landspreading operation where the wastes have not migrated below tilling depth (about 305 to 610 mm (12 to 24 inches)), or a surface impoundment in which the waste is fluid enough to be mechanically aerated and pumped for mixing.

(2) Biodegradation has been used most widely for treatment of oily sludges and refinery waste. Chlorinated solvents such as TCE or PCE are not degraded effectively using current technology; however, work is continuing on these materials. Naturally occurring bacteria and special cultures have been developed which are capable of degrading benzene, phenol, cresol, naphthalene, gasoline, kerosene, and cyanide, and many of their derivatives.

c. Advantages/Disadvantages. In land treatment, if soils are not well aerated, waste degradation will occur only slowly, if at all. Because metals are not degraded, careful attention should be given to the toxic metal load at the site. Since the process can be very slow, additional migration of contaminants may take place during and after treatment. Also, the possibility of forming a toxic byproduct as a result of biodegradation should be considered.

d. Data Requirements.

(1) The type, quantity, and distribution of the waste constituents will have to be determined to select a nutrient, and air requirements.

(2) Tests must be made to determine if microorganisms are naturally occurring which will breakdown the target chemicals. If none are present, enriching or seed cultures may be required.

(3) The site topography, hydrogeology, and soil physical, chemical, and biological properties are also necessary to determine the injection and withdrawal system requirements and design.

e. Design Criteria. The key factors for biodegradation include:

- (1) Nutrient balance.
- (2) pH maintenance.
- (3) Soil aeration and/or oxygen availability.
- (4) Degradation rate of waste constituents.
- (5) Waste constituents and location.

4-27. Chemical Oxidation.

a. Process Description. In-situ leachate treatment introduces a reactant into the contaminated region to interact with the leachate plume. Chemical injection entails injecting chemicals into the ground beneath the waste (see Figure 4-28) to neutralize, precipitate, or destroy the leachate constituents of concern.

b. Applications. Sodium hypochlorite has been used to treat leachate containing cyanide (Tolman et al. 1978). Very little field data are available. The areal spread and depth of the leachate plume must be well characterized so that injection wells can be placed properly to intercept all of the contaminated ground water.

c. Advantages/Disadvantages.

(1) Pollutants may be displaced to adjacent areas when chemical solution is added.

(2) Hazardous compounds may be produced by reaction of injected chemical solution with waste constituents other than the treatment target.

d. Data Requirements. The principal data requirements include the contamination plume characteristics: depth to bedrock, plume cross section, leachate or ground-water velocity, and hydraulic gradient. Also the soil permeability, leachate composition, and reaction rates will have to be determined.

e. Design Criteria. Chemical injection systems are in the conceptual stage of development. The permeability of the soil beneath the waste must be known to determine the ground-water flow through the injected waste and the reaction time between the contaminated ground-water and chemicals.

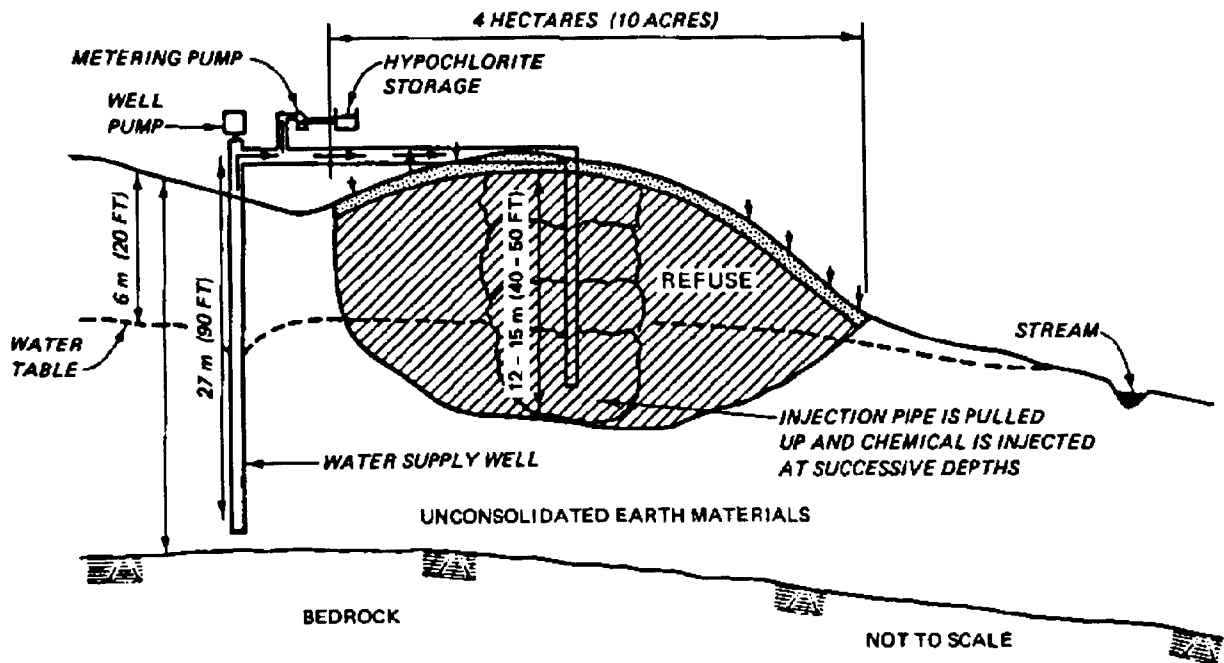

Figure 4-28. Cross Section of Landfill Treated by Chemical Injection

4-28. Permeable Treatment Beds.

a. Process Description. Permeable treatment beds use trenches filled with a reactive permeable medium to act as an underground reactor (see Figure 4-29). Contaminated ground water or leachate entering the bed reacts to produce a nonhazardous soluble product or a solid precipitate.

b. Applications.

(1) Permeable treatment beds are applicable in relatively shallow aquifers since a trench must be constructed down to the level of the bedrock or an impermeable clay. Permeable treatment beds often are effective only for a short time as they may lose reactive capacity or become plugged with solids. Overdesign of the system or replacement of the permeable medium can lengthen the time period over which permeable treatment is effective.

(2) The materials used for this form of treatment are:

(a) Limestone or crushed shell- -Limestone neutralizes acidic ground water and may remove heavy metals such as Cd, Fe, and Cr. Dolomitic limestone ($MgCO_3$) is less effective at removing heavy metals than calcium carbonate limestone. The particle size of the limestone should match a mix of gravel size and sand size. The larger sizes minimize settling of the bed and channeling as the limestone dissolves. The small sizes maximize contact.

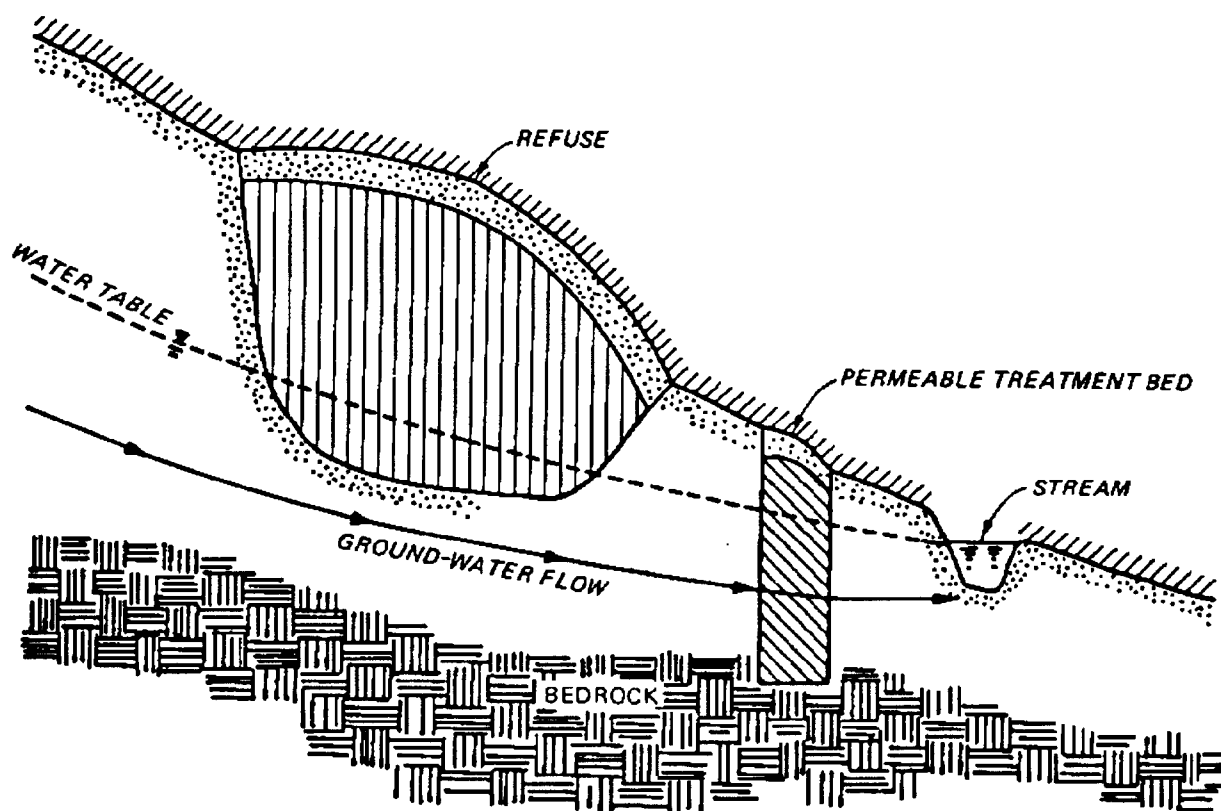

Figure 4-29. Installation of a Permeable Treatment Bed

Extrapolated bench-scale data indicate contact time needed to change 1 pH unit is 8 to 15 days.

(b) Activated carbon--Activated carbon removes nonpolar organic contaminants such as CCl_4 , PCBs, and benzene by adsorption. Activated carbon must be wetted and sieved prior to installation to ensure effective surface solution contact.

(c) Glauconitic green sand--This sand, actually a clay, is found predominantly on the coastal plain of the Mid Atlantic states and has a good capacity for adsorbing heavy metals. Bench-scale studies indicate removal efficiencies of greater than 90 percent for As, Cu, Hg, and Ni, and 60 to 89 percent for Al, Cd, Ca, Cr, Co, Fe, Mg, Mn, and Zn, for detention times on the order of several days.

(d) Zeolites and synthetic ion exchange resins--These materials are also effective in removing solubilized heavy metals. Disadvantages such as short lifetime, high costs, and regeneration difficulties make these materials economically unattractive for use in permeable treatment beds.

c. Disadvantages.

(1) Plugging of the bed may divert contaminated ground water and channeling through the bed may occur. Both problems permit passage of untreated wastes.

(2) Changing hydraulic loads and/or contaminant levels may render the detention inadequate to achieve the design removal level.

d. Data Requirements. The principal data requirements include the contamination plume characteristics: depth to bedrock, plume cross section, leachate or ground-water velocity, and hydraulic gradient. Also the soil permeability, leachate composition, and reaction rates will have to be determined.

e. Design Criteria.

(1) A permeable treatment bed is constructed by digging a trench to an impermeable layer (bedrock or clay), filling the trench with the appropriate material, and capping to control infiltration. The width of the trench is determined by the permeability of the material used for treatment, the ground-water flow velocity, and the contact time required for treatment. These parameters are related as:

$$w_b = (v_b)(t_c) \quad (4-8)$$

where

w_b = barrier width, m

v_b = ground-water flow velocity in the barrier, m/sec

t_c = contact time to achieve the desired removal, sec

Ground-water velocity, v , in turn, is determined by Darcy's law:

$$v = ks \quad (4-9)$$

where

s = the gradient or loss of head per unit length in the direction of flow (unitless)

k = coefficient of permeability, a soil-specific value, m/sec

(2) Since the ground-water velocity through the permeable bed cannot be predetermined, the trench should be designed for the maximum ground-water velocity through the soil. If one assumes the hydraulic gradient is equal for the soil and the permeability bed, the permeability of the barrier must equal that of the soil.

4-29. Soil Flushing.

a. Process Description. Solution mining (extraction) is the application of a solvent to a waste solid or sludge, and collection of the elutriate at well points for the removal and/or treatment of hazardous waste constituents. Typically, solvents used are water, acids (sulfuric, hydrochloric, nitric, phosphoric, carbonic), ammonia, and/or chelating agents such as EDTA which solubilize heavy metals and other inorganic ions. As the solvent is collected, a fraction can be recycled through the landfill with a make-up solution. The remainder can be treated and disposed.

b. Applications. Chemical extraction has been used by the chemical processing and mining industries for many years. The techniques are well understood, but experience with in-situ treatment of hazardous waste is lacking. Therefore, very little data are available on the application of this technology in a remedial action setting. Bench-scale laboratory studies of extraction of heavy metals from sludges and plans to conduct full-scale metal extraction from industrial wastes have been made.

c. Advantages/Disadvantages.

(1) The advantages of the process are that, if the waste is amenable to this technique and distribution, collection, and treatment costs are relatively low, solution mining can present an economical alternative to the excavation and treatment of the wastes. It may be particularly applicable if there is a high safety and health hazard associated with excavation. Also, the effectiveness and completion of the treatment process can be measured via sampling prior to wastewater treatment.

(2) Disadvantages include an uncertainty with respect to adequate contact with wastes; that is, because the wastes are buried, it is difficult to determine whether the solvent has contacted all the waste. Also, containerized waste cannot be treated effectively by this method. Another disadvantage is that the solution mining solvent or elutriate may become a pollutant itself if the system has been poorly designed.

d. Data Requirements. Principal data requirements would include laboratory testing to determine extraction efficiency of the solvents and waste analysis for presence of constituents not compatible with the solvent. Also, field testing and a geohydrologic site survey to establish potential for solvent migration into uncontaminated ground water and to establish well placement sites for collection of the elutriate are required.

e. Design Criteria. The data requirements will determine the selection of an extraction solvent, the well placement for collection of the elutriate, and the injection well locations for the extracting solvent.

4-30. Vapor Extraction.

a. Background. Soils may become contaminated in a number of ways with such volatile organic chemicals as industrial solvents and gasoline components. The sources of contamination at or near the earth's surface include

intentional disposal, leaking underground storage tanks, and accidental spills. Contamination of ground water from these sources can continue even after discharge has stopped because the unsaturated zone above a ground-water aquifer can retain a portion or all of the contaminant discharge. As rain infiltrates, chemicals elute from the contaminated soil and migrate toward ground water.

b. Process Description.

(1) A soil vapor extraction, a forced air venting, or an in situ air stripping system (Figure 4-30) revolves around the extraction of air containing volatile chemicals from unsaturated soil. Fresh air is injected or flows into the subsurface at locations around a spill site, and the vapor-laden air is withdrawn under vacuum from recovery or extraction wells.

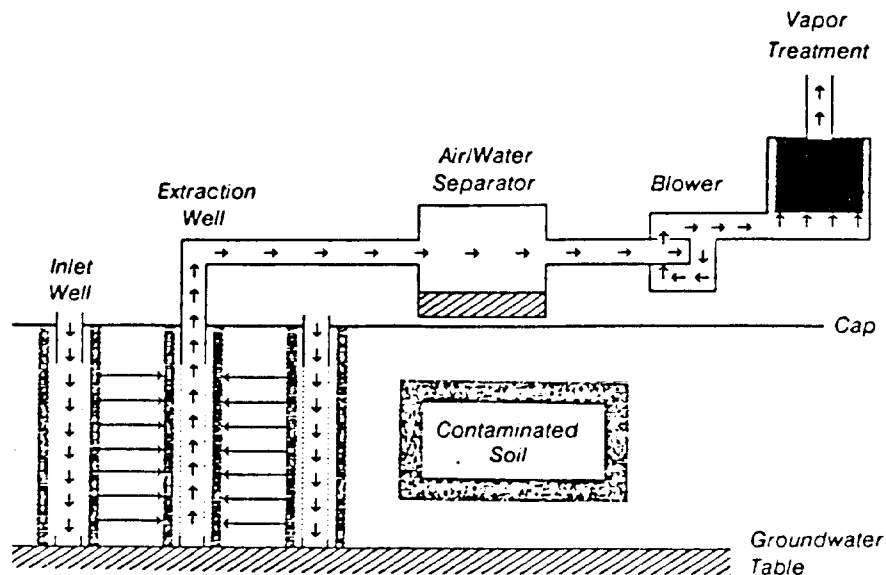

Figure 4-30. Soil Vapor Extraction System (Terravac, Inc.)

(2) In the simplest soil vapor extraction systems, air flows to an extraction well from the ground surface. To enhance air flow through zones of maximum contamination, it may be desirable to include air inlet wells in the installation. These injection wells or air vents, whose function is to control the flow of air into a contaminated zone, may be located at numerous places around the site. Typically, injection wells and air vents are constructed similarly to extraction wells. In some installations, extraction wells have been designed so they can also be used as air inlets. Usually, only a fraction of extracted air comes from air inlets. This indicates that air drawn from the surface is the predominant source of clean air.

(3) Extraction wells are typically designed to fully penetrate the unsaturated zone to the capillary fringe. Extraction wells usually consist of slotted plastic pipe placed in permeable packing and sealed near the surface to avoid "short-circuiting." (See also paragraph 3-13 on wellpoints).

(4) During remediation, the blower is turned on and the air flow through the soil comes to an equilibrium. The flows that are finally established are a function of the equipment, the flow control devices, the geometry of well layout, the site characteristics, and the air permeability of the soil. At the end of operation, the final distribution of VOCs in the soil can be measured to ensure decontamination of the site. Wells may be aligned vertically or horizontally. Vertical alignment is typical for deeper contamination zones and for residue in radial flow patterns. If the depth of the contaminated soil or the depth to the ground-water table is less than 10 to 15 feet, it may be more practical to dig a trench across the area of contamination and install horizontal perforated piping in the trench bottom rather than to install vertical extraction wells. Usually several wells are installed at a site.

(5) The means to verify the success of cleanup is often problematic. Soil sampling is difficult to use because of the uncertainties in replicating the sampling results at a location. Measuring the soil gas concentrations are more repeatable but difficult to relate to regulatory standards, where they exist.

c. Applications. Alternatives for decontaminating unsaturated soil include excavation with onsite or offsite treatment or disposal, biological degradation, and soil flushing. Soil vapor extraction is also an accepted, cost-effective technique to remove volatile organic chemicals from contaminated soils. Soil vapor extraction can be effectively used for removing a wide range of volatile chemicals in a wide range of conditions. The design and operation of these systems is flexible enough to allow for rapid changes in operation, thus, optimizing the removal of chemicals.

d. Advantages/Disadvantages. Advantages and disadvantages of soil vapor extraction are summarized below:

<u>Advantages</u>	<u>Disadvantages</u>
Minimal disturbance of the contaminated soil	There are few guidelines for the optimal design, installation, and operation of soil vapor extraction
Systems can be constructed from standard equipment	Theoretically based design equations defining the limits of this technology are lacking and system designs are mostly empirical
Systems have been demonstrated at pilot- and field-scale	
Systems can be used to treat larger volumes of soil than are practical for excavation	Alternative designs can only be compared by the actual construction, operation, and monitoring of each design
Systems have the potential for product recovery system	

(Continued)

<u>Advantages</u>	<u>Disadvantages</u>
Spills can be cleaned up before the chemicals reach the ground water table	Vapors and condensed liquids collected from the wells may require treatment prior to discharge to the air
Systems can be integrated with other cleanup technologies to provide complete restoration of contaminated sites	Extraction of volatile chemicals from clays and silts may be difficult
Can treat soils at depths greater than in range of excavation	Determining when the site is sufficiently clean to cease operation

e. Data Requirements. A number of variables characterize the successful design and operation of a vapor extraction system:

(1) Site conditions: Distribution of VOCs, depth to ground water, infiltration rate, location of heterogeneities including paved or sealed areas, temperature, atmospheric pressure.

(2) Soil properties: Permeability, porosity, organic carbon content, soil structure, soil moisture characteristics, particle size distribution.

(3) Control variables: Air withdrawal rate, well configuration, extraction well spacing, vent well spacing, ground surface covering, inlet air VOC concentration and moisture content, pumping duration.

(4) Response variables: Pressure gradients, final distribution of VOCs, final moisture content, extracted air concentration, extracted air temperature, extracted air moisture, power usage.

(5) Chemical properties: Henry*s constant, solubility, adsorption equilibrium, diffusivity (air and water), density, viscosity.

f. Design Criteria. The design and operation of soil vapor extraction systems can be quite flexible; changes can be made during the course of operation with regard to well placement, or blower size, or air flows from individual wells. If the system is not operating effectively, changes in the well placement or capping the surface may improve it. Based on the current state of the technology of soil vapor extraction systems, the following design criteria can be recommended.

(1) Intermittent blower operation is probably more efficient in terms of removing the most chemical with the least energy.

(2) Extraction wells are usually screened from a depth of from 1.5 to 3 m (5 to 10 feet) below the surface to the ground-water table. For thick zones of unsaturated soil, maximum screen lengths of 6.1 to 9.1 m (20 to 30 feet) are specified.

(3) Air/water separators are simple to construct and should probably be installed in every system.

(4) Installation of a cap over the area to be vented reduces the chance of extracting water and extends the path that air follows from the ground surface, thereby increasing the volume of soil treated.

(5) Incremental installation of wells, although probably more expensive, allows for a greater degree of freedom in design. Modular construction where the most contaminated zones are vented first is preferable.

(6) Use of soil vapor probes in conjunction with soil borings to assess final cleanup is less expensive than use of soil borings alone. Usually a complete materials balance on a given site is impossible because most sites have an unknown amount of VOC in the soil and in the ground water.

(7) Soil vapor extraction systems are usually only part of a site remediation system.

(8) Although a number of variables intuitively affect the rate of chemical extraction, no extensive study to correlate variables to extraction rates has been identified.

(9) Well spacing is usually based on some estimate of the radius of influence of an individual extraction well. Well spacing has ranged from 15 to 100 feet. Well spacing should be decreased as soil bulk density increases or the porosity of the soil decreases. One of the major differences noted between systems was the soil boring diameter. Larger borings are preferred to minimize extracting liquid water from the soil.

(10) Wells should be constructed with approximately 20 feet of blank casings between the top of the screen and the soil surface to prevent the short circuiting of air and to aid in the extraction of deep contamination.

(11) Initial VOC recovery rates are relatively high, then decrease asymptotically to zero with time. Several studies have indicated that intermittent venting from individual wells is probably more efficient in terms of mass of VOC extracted per unit of energy expended. This is especially true when extracting from soils where mass transfer is limited by diffusion out of immobile water.

(12) Optimal operation of a soil vapor extraction system may involve taking individual wells in and out of service to allow time for liquid diffusion and to change air flow patterns in the region being vented.

(13) Air injection has the advantage of controlling air movement, but injection systems need to be carefully designed.

CHAPTER 5

DISPOSAL TECHNOLOGIES

5-1. Definition. A disposal system is a properly engineered facility used for ultimate disposal of hazardous waste into or on land or water.

5-2. Applicability.

a. Disposal systems have general applicability to all types of waste streams. The different disposal techniques are collectively capable of handling wastes in solid, semisolid, and liquid forms. As many disposal systems have shown migration or dispersion of the contaminants to the surrounding environment, there is usually strong public resistance to siting a solid or hazardous waste disposal facility.

b. Disposal is often the method selected for final disposition of a waste material when available treatment or recovery options are not technically or economically feasible. For any disposal technique selected, care should be taken to ensure that the design, construction, and operation of a facility are based on sound engineering principles and are within regulatory guidelines.

5-3. Techniques. The specific disposal techniques addressed in this chapter include landfilling and deep well injection. Incineration, often considered as a disposal technique, is covered here as a treatment technology and has been discussed previously in Chapter 4. The following sections address the disposal of wastes in offsite and onsite landfills.

5-4. Regulatory Constraints.

a. Severe regulatory constraints are placed on the construction and operation of both landfills and deep well injection systems. Many of these regulatory requirements are subject to the interpretation of the Federal and state agencies having regulatory authority over the site or facility. Designers must coordinate with the appropriate agencies to ensure regulatory compliance at all steps of the process.

b. Of particular impact on the disposal of wastes are the "land ban" regulations promulgated under RCRA. These regulations effectively ban the landfilling of specific waste classifications without prior treatment in accordance with best demonstrated available technology (BDAT). With respect to the remediation of uncontrolled hazardous waste sites, the application of the land ban regulations is unclear, especially for soils and debris, and must be addressed on a site-specific basis with the appropriate regulatory authority.

Section I. Onsite Disposal

5-5. General. Onsite disposal incorporates the construction and subsequent operation of disposal facilities on or near the site being remediated. The primary advantage of onsite disposal is the reduction of the requirement for transporting the wastes, sometimes over long distances, to an offsite disposal facility. The primary disadvantages of onsite disposal are the commitment to the long-term operation and maintenance of such a facility and the potential loss of the land productive use.

5-6. Landfills.

a. Description of Technique.

(1) A landfill is defined as a disposal facility or part of a facility where hazardous waste in bulk or containerized form is placed in or on land, typically in excavated trenches or cells. Differentiating between landfills and surface impoundments may be difficult in certain cases; although surface impoundments are designed intentionally to hold liquid waste, landfills may also accept bulk liquids under certain conditions. Bulk or noncontainerized liquid waste or waste containing free liquids must not be placed in a landfill unless: (a) the landfill has a liner and a leachate collection and removal system that meet the requirements of 40 CFR 264.310(a), or (b) before disposal, the liquid waste is solidified.

(2) The primary restriction on landfilling of hazardous wastes is the elimination of liquid disposal. Bulk liquids or sludges with leachable liquids must not be landfilled at Department of the Army hazardous waste facilities; disposal of such wastes will be permitted only in surface impoundments. RCRA regulations permit disposal of liquids in small containers in an overpack drum (lab pack), provided that the latter contains sufficient absorbent material to absorb all of the liquid contents of the inside containers. The inside containers must be nonleaking and compatible with the contained waste. The overpack drum must be an open-head, DOT-specification metal shipping container of no more than 110-gallon capacity. Batteries, capacitors, or similar nonstorage containers which contain free liquids may be landfilled.

(3) Landfills should be sited in a hydrogeologic setting that provides maximum isolation of the waste from ground water. This is achieved by vertical separation of wastes from the uppermost ground water, and low permeability of the subsurface material providing the hydraulic separation. In addition, the landfill must be located above the 100-year flood level and not interfere with major surface drainage.

(a) Ideally, the soils in the area should be suitable for daily cover as well as final cover. In cold regions where frost penetration is significant (3 to 6 feet), the cover material should be stockpiled in as dry a condition as possible to facilitate wintertime operations.

(b) Location of landfills in karst terrain (or similar geologic formations) and in seismic zones 3 and 4 (as defined in Department of the

Army, TM 4-809-10) should be avoided whenever possible. However, if landfills are sited in such areas, the following precautions should be taken:

! An extensive geological investigation must be performed to ensure that the facility is not located on or in the near vicinity of sink holes or caverns and that the soil and rock in the area are suitable for location of this type of facility.

! After the final site selection has been completed, HQUSACE will be notified of proposed location and geological conditions. This notification will be made a minimum of 30 days before design begins.

(4) Disposal by landfilling involves placement of wastes in a secure containment system that consists of double liners, a leak-detection system, a leachate-collection system, and a final cover. Wastes delivered to the landfill are unloaded by forklift or front-end loaders and placed in the active waste lift. Hazardous materials will be segregated in cells or subcells according to physical and chemical characteristics to prevent mixing of incompatible wastes. Following their placement, the hazardous wastes will be covered with sufficient soil to prevent wind dispersal. Successive lifts will be placed and the cover soil graded so that any direct precipitation is collected in a sump. All direct precipitation collected in the sump will be tested for contamination. As filling continues, wastes will be placed so as to direct any run-off toward a temporary sump at the lower segment of the base liner. For operations during extremely wet conditions, tarpaulins may be used to cover the active area to minimize infiltration of rainfall. In high rainfall regions, semipermanent roof/rainfall protection may be installed over the entire cell using either rigid or stress-tensioned structures. The structure should be designed to prevent all rainfall from entering the cell until final cover is completed; then it is dismantled and erected over the next cell. Another alternative to operations during extremely wet weather is to containerize or store wastes until the rainfall season is over. As areas of the secure landfill are filled to final grade, a final soil cover will be installed in accordance with the facility's operation plan. Figure 5-1 illustrates a cross section of a chemical waste landfill with a leachate collection system.

(5) The major design elements of hazardous wastes landfills are listed below:

- (a) Double liners separated by a permeable layer such as sand.
- (b) A leak detection system between the liners.
- (c) A leachate collection and removal system above the top liner.
- (d) Water run-on and run-off control systems.

(e) A final cover to minimize infiltration of precipitation into the closed landfill.

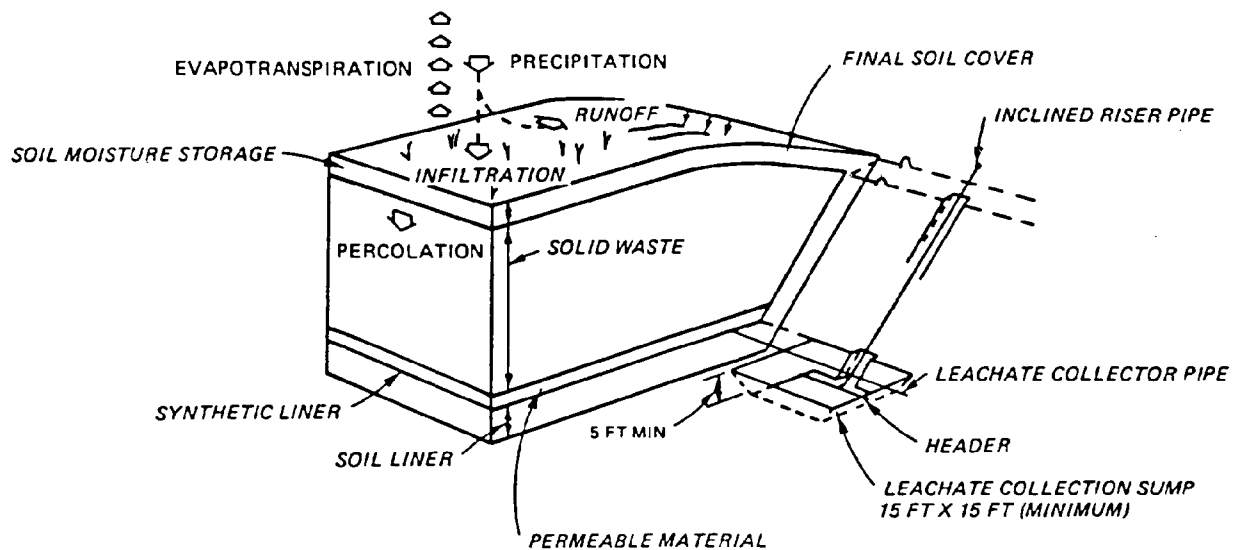

Figure 5-1. Cross Section of a Chemical Waste Landfill with Leachate Collection

(f) The base liner system is designed and constructed to prevent migration of wastes during the active life of the disposal unit into the liner, and out of the landfill into subsurface soil, ground water, or surface water. A leak detection system between the double liners enables the detection and removal of any seepage, and evaluation of liner performance. Located above the double liners is the leachate collection and removal system, which consists of slotted drainage pipes designed to collect leachate that flows under the influence of gravity to low points within the landfill. The leachate collection and removal system must be designed and operated to ensure that the depth of leachate over the liner does not exceed one foot.

(6) Closure of a landfill is achieved by installing a final cover which has a permeability less than or equal to that of the bottom liner. The cover should be capable of minimizing infiltration of liquids, functioning with minimum maintenance, promoting drainage and minimizing erosion of cover, and accommodating settling and subsidence.

(7) Secure landfills require equipment for handling wastes and cover material, performing support functions, spill and fire control, and decontamination. For waste handling, a forklift and a front-end loader are typically used to unload and place containers and solid materials in assigned active waste lifts. Dozers and self-loading scrapers are used to spread and compact cover material. For grading final surfaces, the crawler dozer is effective; it can economically doze earth over distances up to 300 feet. Scrapers can haul cover material economically over relatively long distances (more than 305 m (1,000 feet)). Since construction equipment is heavy when loaded, precautions must be taken in placing initial lifts of wastes over the base liner. Subsequent lifts of bulk wastes and soil cover should be consolidated by compactors to minimize settlement.

(a) Support equipment for a secure landfill may include a road grader, water truck, pickup trucks, and vacuum trucks. The road grader can be used to maintain dirt and gravel roads on the site, to grade the soil cover, and to maintain any unlined drainage channels surrounding the fill. Water trucks range from converted tank trucks to highly specialized, heavy vehicles that are generally used in road construction operations. They are used at the landfill for construction, to control dust, and if necessary, fight fires.

(b) In accordance with 40 CFR 264.32, all facilities must be equipped with communication or alarm systems, fire control equipment, spill control equipment, and decontamination equipment (unless an exemption is obtained from the EPA Regional Administrator).

(c) All equipment used to unload and place wastes must be decontaminated before being taken out of the disposal operation and staging area. Incoming vehicles not used in the unloading operation should be restricted to staging areas or clean soil areas within the landfill.

b. Applicability of Landfilling.

(1) Landfilling can be expected to undergo close public scrutiny. Landfilling is considered a suitable method for disposing of most wastes with some exception, including bulk liquids and ignitable or reactive wastes. If these wastes are solidified or made nonignitable or nonreactive in compliance with 40 CFR 264.312 through 264.316, then they may be placed in a hazardous waste landfill. Other wastes requiring special handling or pretreatment prior to landfilling include wastes with free liquids, incompatible wastes, infectious wastes, and contaminated wastes.

(2) Wastes containing PCBs are regulated under the Toxic Substances Control Act (TSCA) (PL 94-469). Wastes containing PCBs in concentrations between 50 and 500 parts per million can be incinerated or disposed of in a chemical waste landfill in accordance with 40 CFR 761, Subpart D. These wastes, if disposed of in a chemical waste landfill, must also meet all RCRA regulations regarding ignitability, reactivity, and free liquid. Wastes containing PCBs in excess of 500 parts per million must be incinerated.

(3) Radioactive wastes require special landfills and are not included in this discussion. Radioactive waste disposal is regulated separately by the NRC and is not regulated under RCRA and CERCLA.

c. Data Requirements. The data requirements needed for planning and designing a hazardous waste landfill are detailed in 40 CFR Part 264, Subpart B, Sections 264.13 and 264.18, and Part 267, Subpart B, Section 267.10, Subpart C, Sections 267.21 and 267.23, and for TSCA landfills in 40 CFR Part 761 Subpart D. The reader is referred to the specific sections in the CFR for additional details and requirements. In general, data requirements for specific activities are as follows:

(1) General waste analysis to include a detailed chemical and physical analysis of a representative sample of the waste for disposal (Section 264.13).

- (2) Location standards (Section 264.18).
 - (a) Seismic information including location and activity of any faults in the immediate area.
 - (b) Floodplain locations.
- (3) Environmental performance standards (Section 267.10), general design requirements (Section 267.21), and closure and postclosure (Section 267.23).
 - (a) Proposed volume of waste for disposal.
 - (b) Physical and chemical characteristics of the waste.
 - (c) Hydrogeological characteristics.
 - (d) Quantity, quality, and direction of ground-water flow.
 - (e) Ground-water use and withdrawal rates.
 - (f) Topographic information.
 - (g) Climatological conditions.
 - (h) Hydrologic data including surface flow patterns.
 - (i) Amount and uses of nearby surface waters, along with associated water quality standards.
 - (j) Quality of nearby surface waters.
 - (k) Potential for waste volatilization and wind dispersal.
 - (l) Existing quality of the air.
 - (m) Land use and zoning patterns.
 - (n) Physical and chemical properties of the soil underlying the facility that supports an in-place liner.
 - (o) Permeability of the liner material.
 - (p) Potential pressure head of leachate on the liner.
 - (q) Potential for damage to the liner system during installation of an in-place liner.
 - (r) Potential volume of leachate or contaminated run-off that could be produced at the facility.
 - (s) Source and characteristics of potential cover material.

(t) Potential for health risks due to human exposure to waste constituents.

(u) Potential damage to wildlife, crops, vegetation, and physical structures due to exposure to waste constituents.

d. Design Criteria.

(1) The design criteria as given in the current regulations for both sanitary landfills and hazardous waste landfills are generally based on performance standards rather than specific design and construction requirements. That is, the owner/operator is responsible for ensuring or demonstrating to the appropriate regulatory agency that the landfill design being proposed will meet a number of performance standards (given in the regulations) when constructed and operated according to the design plan.

(2) The Part 241 regulations covering solid waste or sanitary landfills are structured in sections addressing individual aspects of landfill design and operation with each section divided into three subsections including: (a) requirement, (b) recommended design procedures, and (c) recommended operations procedures. The requirement subsections generally address the performance standards with the other two subsections addressing recommended procedures for design and operation. Therefore, landfills to be operated in the private sector are required to be designed to meet the performance standards but are not required to follow the guidelines in detail, In the case of landfills to be operated within the management control of a Federal agency, both the performance standards and the design and operating guidelines are mandatory pursuant to Section 211 of the Solid Waste Disposal Act, as amended (PL 89-272 and PL 91-512). In either case, many of the recommended design procedures are not specific and place the responsibility for developing specific design criteria on the potential owner/operator.

(3) Subpart N of Part 264 (264.301) contains the design and operating standards for landfills used to dispose of hazardous wastes. The basic requirements are:

(a) A liner to prevent migration of wastes out of the landfill and into subsurface soil or ground water or surface water during the landfill*s active life.

(b) A leachate collection and removal system.

(c) Control of run-on and run-off.

(d) Capping the wastes at closure and conducting postclosure care.

(e) To provide flexibility, the design and operating characteristics required are expressed in terms of performance standards for system components as a whole.

(4) The regulations (Part 264 Subpart N) require the system to function through scheduled closure and to consist, at a minimum, of a leachate

collection and removal system and at least one liner. The function of the leachate collection and removal system is to minimize the head (depth) of leachate on the liner. It must be capable of achieving a leachate head of one foot or less. The liner itself must be designed and constructed to prevent migration of liquids and allow no more than the minimum infiltration of liquids into the liner itself.

(5) The liner system must be designed and built to achieve containment of fluids during the life of the landfill unit, thus preventing the escape of hazardous constituents to surrounding soils and ultimately to the ground water. There must be at least one liner, and the material used must be resistant to the chemicals it will encounter in the wastes and in the leachate, and be of sufficient strength to withstand the forces it will encounter during installation and operation. A base is required to provide sufficient support to the liner to prevent failure. The liner system must cover all areas that are likely to be exposed to the waste and leachate.

(6) A cap or final cover must be designed to minimize infiltration of precipitation into the landfill after closure. It must be no more permeable than the liner system. It must operate with minimum maintenance and promote drainage from its surface and at the same time minimize erosion. The design must also accommodate settling and subsidence to minimize the potential for disrupting the continuity and function of the final cover as well as prevent water from ponding on the site.

(7) Two specific location standards concerning siting of a hazardous waste landfill are given in 40 CFR, Part 264, Subpart B, General Facility Standards. Section 264.18 pertains to seismic considerations and floodplains. The reader is referred to this section in the CFR for additional information and requirements.

(8) 40 CFR, Part 761, Subpart D, Section 761.75 contains the design and operation standards for chemical waste landfills used for disposal of PCB wastes. The basic requirements are:

(a) A synthetic liner if the in-place or compacted soil liner does not have a permeability equal to or less than 1×10^{-7} cm/sec.

(b) A leachate collection monitoring system to be monitored monthly for quantity and quality.

(c) Ground-water monitoring system.

(d) Flood protection.

(9) Whenever a synthetic liner is used, special precautions will be taken to ensure that its integrity is maintained and that it is chemically compatible with the waste. Adequate measures should be provided to prevent excessive stresses on the liner due to inadequate subgrade preparation, equipment loads, or improper waste/cover placement methods. The liner must have a minimum thickness of .76 mm (30 mils); a 1.02 mm (40-mil) liner is usually recommended.

(10) If the landfill is located below the 100-year floodwater elevation, surface water diversion dikes around the perimeter of the landfill site with a minimum height equal to 0.6 m (2 feet) above the 100-year floodwater elevation will be provided. If the landfill is above the 100-year floodwater elevation, the operators will provide diversion structures capable of diverting all of the surface water run-off from a 24-hour, 25-year storm.

(11) PCB wastes will be placed in the landfill in a manner that will prevent damage to containers or articles. Other wastes placed in the landfill that are not chemically compatible with the PCB wastes including organic solvents will be segregated from the PCBs throughout the waste handling and disposal process.

e. Onsite or Offsite Landfill Considerations. Several considerations must be made when determining whether to use an onsite or offsite landfill. The determination will have to be made on a site-specific basis. Onsite landfilling will require land and large capital expenses to prepare a landfill for burial of hazardous waste. The problem of public acceptance of onsite burial of waste that is to be "cleaned-up" is another consideration. Also, the long-term monitoring that a landfill will require can become a very expensive operation.

f. Advantages/Disadvantages.

(1) Landfilling is in many cases the most expedient, economical, and best understood method of disposing of wastes. Landfilling is generally the most economical method for disposing of large volumes of wastes, especially those with a low hazard to the environment and public health or where other options are not technically feasible.

(2) The disadvantages of landfilling are related to the concept of landfilling as a very long-term storage of waste material. The contaminants landfilled are not generally destroyed or rendered harmless. The requirements imposed by the RCRA and TSCA regulations have significantly increased the cost of landfilling due to requirements for more stringent site security; long-term monitoring, operation, and management; and the imposed long-term liability. The distribution of responsibility for contamination problems resulting from a landfilling operation even if it is properly permitted has not been totally defined and thus will probably result in numerous legal actions. Local public resistance to siting of landfills around high population areas, and even in some rural areas, has been significant and is expected to continue.

(3) Nevertheless, landfilling in a site that meets RCRA and state requirements will continue to be a viable and cost-effective disposal method for both sanitary and hazardous wastes.

5-7. Deep Well Injection.

a. Description. In general, an underground well injection is simply the subsurface discharge of fluids through a bored, drilled, or driven well, or through a dug well, where the depth of a dug well is greater than the largest horizontal surface dimension. Injection wells must be designed to

prevent fluid movement into underground aquifers used for drinking water. There must be no significant leak in the casing, tubing, or packer; and no significant fluid movement into an underground source of drinking water through vertical channels adjacent to the injection well bore. Testing for leaks can be achieved through monitoring of annulus pressure or pressure test with liquid or gas. The absence of significant fluid movement can be determined through the use of well records demonstrating the presence of adequate cement to prevent such migration (class II wells only) or the results of a temperature or noise log. The general requirements for underground injection wells are that they shall be located, designed, constructed, operated, maintained, and closed in a manner that will ensure protection of human health and the environment. Underground injection is divided into five classes of wells (see 40 CFR 122.32 and 40 CFR 146.5) under regulations promulgated under the RCRA. Design and operating criteria for the five classes of wells are detailed in the RCRA regulations (40 CFR 146). An example of a deep injection well is presented in Figure 5-2.

b. Applicability.

(1) An investigation of all alternate disposal methods should be accomplished before deep well injection is considered. Deep well injection should be considered only when the hazardous liquid wastes cannot be treated or disposed of in other economical ways.

(2) Subpart C of 40 CFR Part 267 (interim) regulations pertains to new underground injection wells classified as class I wells (40 CFR 122.32) and are very general in nature. The reader is referred to 40 CFR 146 for more detailed information about design and operating requirements. In addition, the Subparts B, C, D, E, G, and H of Part 264 and Part 264.18 apply as well.

c. Data Requirements.

(1) In general, data requirements for determining and specifying casing and cementing requirements are as follows:

- (a) Depth to the injection zone.
- (b) Injection pressure, external pressure, internal pressure, and axial loading.
- (c) Hole size.
- (d) Size and grade of all casing strings.
- (e) Corrosiveness of injected fluid, formation fluids, and temperatures.
- (f) Lithology of injection and confining intervals.
- (g) Type or grade of cement.

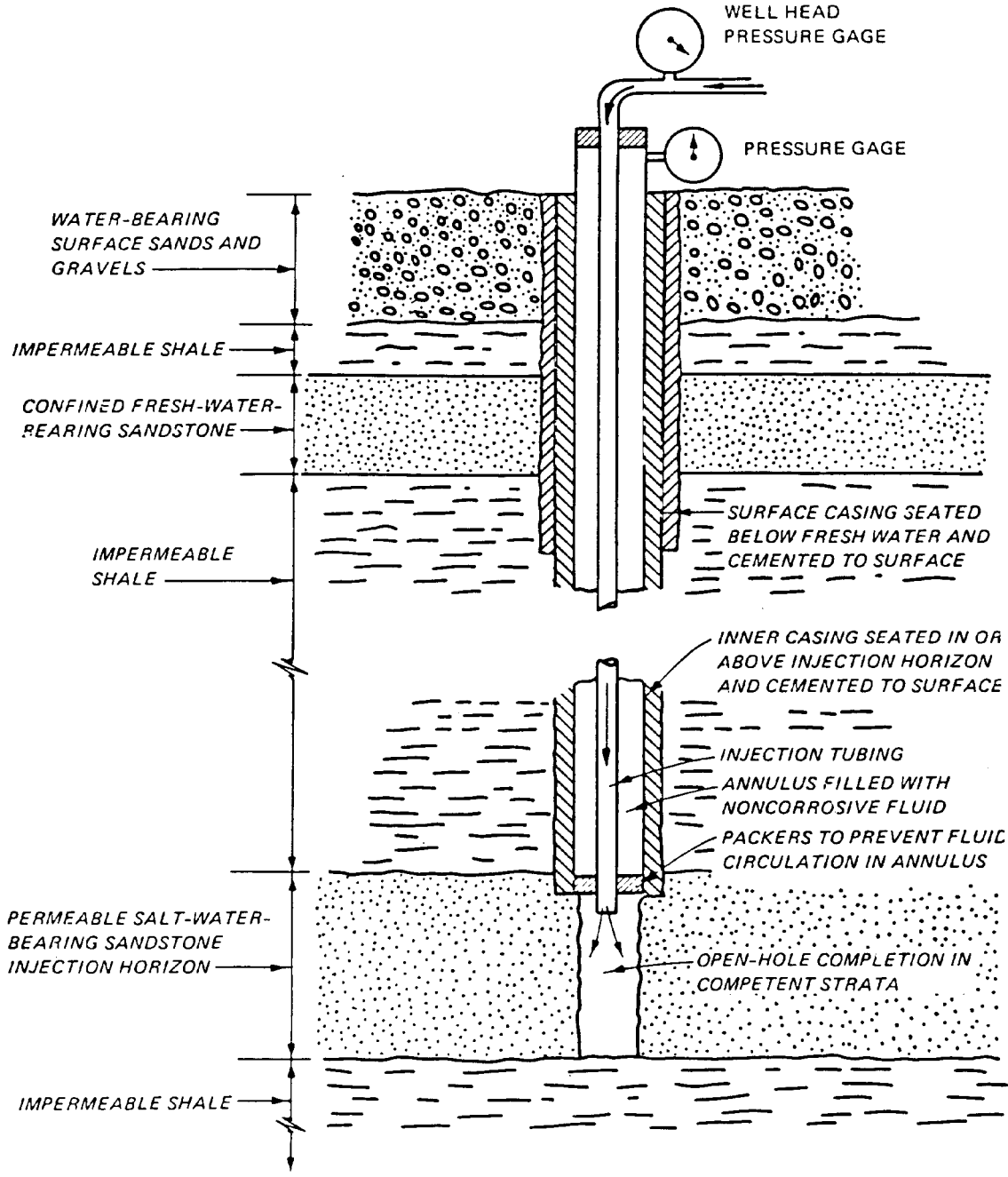

Figure 5-2. Deep Injection Well

(2) 40 CFR 146.12, lists the construction requirements in detail, and 40 CFR 146.13 lists the operating, monitoring, and reporting requirements that are in addition to the requirements of 40 CFR 264 and 267. In general, the data requirements are as follows:

(a) General waste analysis to include a detailed chemical and physical analysis of a representative sample of the waste to be disposed of (40 CFR 264.13).

(b) Data required to support the location standards (40 CFR 264.18) include:

! Seismic information including location and activity of any faults in the immediate area.

! Floodplain locations.

(3) Data required to support the environmental performance standards (40 CFR 267.10), general design requirements (40 CFR 267.21), and closure and postclosure (40 CFR 267.23) include:

(a) Proposed volume of waste for disposal.

(b) Physical and chemical characteristics of the waste.

(c) Hydrogeological characteristics.

(d) Quantity, quality, and direction of ground-water flow.

(e) Ground-water use and withdrawal rates.

(f) Potential for health risks due to human exposure to waste constituents.

(g) Potential damage to wildlife, crops, vegetation, and physical structures due to exposure to waste constituents.

(h) Hydrologic data including surface flow patterns.

(i) Topographic information.

(j) Climatological conditions.

(k) Amount and uses of nearby surface waters, along with associated water quality standards.

(l) Quality of nearby surface waters.

(m) Potential for waste volatilization and wind dispersal.

(n) Existing quality of the air.

(o) Land use and zoning patterns.

d. Design Criteria. Underground Injection Control (UIC) Program regulations require all aspects of injection well systems to be reported and classified, including construction requirements that pertain to casing type and cement type, well dimensions, waste characteristics, corrosiveness, and leak prevention. The regulations also call for tests and logs, including electric logs on the injection zone formation and integrity of completed wells. In addition, midcourse evaluation of well performance is required for the first two years of operation. In general, all types of materials and procedures must be specifically described or referenced. As an example, steel and concrete corrosion resistance to the waste stream must be demonstrated.

Section II. Offsite Disposal

5-8. General.

a. Offsite disposal exploits the use of existing commercial disposal facilities. The primary advantage of offsite disposal is the minimization of the responsibility for long-term operation and maintenance of such a facility. A secondary advantage is the ability to maintain productive land uses. The primary disadvantage of offsite disposal is the requirement for transporting the wastes, usually over long distances, to an offsite disposal facility.

b. Requirements for offsite disposal must be coordinated with the operator of the offsite disposal facility. Each offsite disposal facility operates in accordance with facility-specific permit requirements. Operators strictly control waste-disposal operations. If offsite disposal is contemplated, coordination should be accomplished early in the design process.

c. Section 121 of CERCLA states that offsite disposal should be the least preferred remedial action alternative. This is not an outright prohibition; however, use of the offsite disposal option should be fully justified and documented during the planning and design process.

5-9. Landfills. The use of offsite landfills presents problems. Transportation of hazardous waste requires manifesting procedures and decontamination of equipment and trucks leaving the site. Haul routes have to be established, approved, and followed. When bids are being considered, the contractor*s proposed disposal facilities should be checked to be sure that they can legally receive and will receive the waste in question. Also, the transportation of certain wastes such as bulk explosive solids should be considered. At the Chem-Dyne remedial action site DOT regulations required that explosive solids be drummed before transporting. This resulted in very expensive handling and extra disposal costs. A similar problem was experienced with "solids" at the site. In most cases the "solids" had to be solidified to meet the landfill*s requirements for disposal. After solidification with bulking agents (fly ash, corn cobs, etc.) the volume and weight were greatly increased. Since disposal costs were determined on a "as disposed of" basis, the costs were much greater than originally estimated. If an offsite disposal facility is going to be used, a determination of who shall sign the manifest (contractor, Corps, or EPA) should be made before the

project is initiated. Constriction Bulletin (CB) 93-6, Hazardous Waste Manifest Signature Policy and Procedures; CB 91-13, Preparation and Signature of Hazardous Waste Manifests and Land Ban Certificates on EPA Superfund Projects; CB 92-1, Asbestos Notification and Waste Shipment Record Requirements; and EP 200-1-2, Process and Procedures for RCRA Manifesting, provide current guidance on this topic. Also, a percentage of the payment to the contractor should be held back until manifests are received from the landfill indicating that the waste has been ultimately and properly disposed of. Offsite landfill disposal should be considered for disposal of dewatered contaminated dredged material and for treated residuals. These options include sanitary landfills, RCRA landfills, and TSCA landfills.

a. Sanitary landfills.

(1) Sanitary landfills are facilities designed primarily for the disposal of solid wastes on the land. Wastes are usually emptied into cells, spread, and compacted, and then covered daily with a 152-mm (6-inch) layer of soil or other suitable material. Solid wastes placed in sanitary landfills originate from residential and commercial sources. Wastes that may pose a substantial present or future hazard to human health or living organisms are excluded from a conventionally designed sanitary landfill. Therefore, as a disposal option for remediation of contaminated site, these facilities are applicable to relatively clean residuals from other treatment or pretreatment processes.

(2) Disposal of liquid material in a landfill would likely require elimination of free-draining water either by dewatering and drying or by solidification. Implementation and cost are affected by the distance and cost for transport to a landfill that would accept the material. Landfill fees are also significant. Because landfills are commonly used for municipal waste disposal, there may a local landfill relatively close to the project area. However, the demand for landfill capacity has resulted in restrictions on what many landfills will accept, particularly for large volumes of material.

(3) Sanitary landfills are regulated under the Solid Waste Disposal Act as amended by the Resource Act of 1970 and RCRA. Federal regulations providing guidelines for land disposal of solid wastes are presented in 40 CFR Part 241. These guidelines state that landfills should avoid effects on ground water and surface water, but design requirements are much less stringent than those presented in more recent regulations for RCRA hazardous waste facilities. Increased awareness of the potential hazards of landfills is being reflected in more stringent interpretation of design requirements for these facilities that will protect the environment.

b. RCRA Landfills.

(1) RCRA landfills are permitted for the disposal of certain hazardous wastes as defined under RCRA. RCRA landfills must meet requirements specified in 40 CFR Part 264.

These requirements include lining the bottom and sides of the site with two or more liners, a leachate collection system above the top liner, and a leachate detection system between the two liners. The top liner is a geosynthetic material referred to as a flexible membrane liner (FML), and the bottom liner is an FML or a 3-foot-thick compacted clay liner. The U.S. EPA currently favors a bottom liner that is a composite of an FML underlain by a clay liner. Closure of a RCRA landfill requires covering with a minimum of a three-layer cover consisting of a vegetative top cover, a drainage layer, and a composite (FML over compacted clay) liner. In addition to monitoring the leachate collection and removal system, a ground-water monitoring program is also required for a RCRA landfill.

(2) Permitted RCRA facilities are few in number, their availability for contaminated dredged material is limited, and the cost for transportation and disposal will be large. The U.S. EPA regulations prohibit placement of liquids in RCRA landfills. Therefore, liquid wastes will have to be dried or solidified before the landfill will accept it.

c. Toxic Substance Control Act (TSCA) landfills.

(1) TSCA landfills are defined here as chemical waste landfills designed and constructed to comply with the provision of TSCA as defined in 40 CFR Part 761. This regulation establishes prohibitions of, and requirements for, the manufacture, processing, distribution in commerce, use, disposal, storage, and marking of PCBs and PCB items. In contrast to RCRA regulations for hazardous waste, which do not mention dredged material specifically, the TSCA regulation states that all dredged materials containing PCBs at concentrations greater than 50 mg/l (50 ppm) shall be disposed of in an incinerator (required if the concentration is greater than 500 mg/l (500 ppm)), in a TSCA landfill, or other method subject to the approval of the U.S. EPA Regional Administrator.

(2) Requirements for TSCA landfills include a requirement to locate in thick, relatively impermeable formations or to provide a 0.9 m (3-foot-thick) compacted clay liner with permeability less than 1×10^{-7} cm/sec. An FML with a minimum thickness of 0.76 mm (30 mils) and that has proven chemical compatibility with the waste may be substituted for the clay liner. The bottom of the site must be at least 15.2 m (50 feet) above the historical high water table. Ground-water monitoring and leachate collection systems are also required. As with RCRA landfills, materials containing free-draining liquids cannot be placed in the landfill for final disposal.

(3) Landfills designed specifically to meet TSCA requirements have limited availability. Disposal alternatives considered for dredged material contaminated with PBS at concentrations greater than 50 mg/l (50 ppm) have included confined disposal facilities designed to TSCA standards. These standards are in some ways less stringent than RCRA. However, the requirement to locate 15.2 in (50 feet) above the water table would prohibit implementation in many areas. Cost of this option is expected to be in the same range as for RCRA landfills.

EM 1110-1-502
30 Apr 94

5-10. Deep Well Injection. The use of deep well injection for offsite disposal presents many of the same problems as offsite landfills. The technical guidance presented in paragraph 5-7 is also applicable for offsite work.

APPENDIX A

REFERENCES

A-1. Required Publications.

PL 89-272.

PL 91-512.

PL 94-469.

PL 94-580.

PL 96-463.

PL 96-510.

29 CFR 1910.

40 CFR 122, 146, 230, 241, 260, 261, 262, 264, 267, 761.

40 CFR 300.

49 CFR 171-177, 263.

46 FR 2867.

47 FR 143.

55 FR 8666.

TM 4-809-10.

ER 385-1-92.

ER 1165-2-132.

EP 200-1-2.

EM 385-1-1.

CB 91-13 (available from CEMP-G).

CB 92-1 (available from CEMP-G).

CB 93-6 (available from CEMP-G).

American National Standards Institute Safety (ANSI) Standard(s). Available from ANSI, 430 Broadway, New York, NY 10018.

EM 1110-1-502
30 Apr 94

- Arthur D. Little, Inc. 1976 (Nov). "Physical, Chemical and Biological Treatment Techniques for Industrial Wastes," Report to U.S. Environmental Protection Agency, Office of Solid Waste Management. Available through National Technical Information Service, Report No. PB-275-054/5GA (Vol I) and PB-275-278/1GA (Vol II). U.S. Department of Commerce, 5285 Port Royal Road, Springfield, Virginia 22161.
- Badger, W.L. and Banchemo, J.T. 1955. Introduction to Chemical Engineering, McGraw-Hill, 1221 Avenue of the Americas, New York, New York 10020.
- Chemical Manufacturers Association. 1982. A Hazardous Waste Site Management Plan, 2501 M St., N.W., Washington, D.C. 20037.
- Culp, R. L., et al. 1978. Handbook of Advanced Wastewater Treatment, Van-Nostrand Reinhold Co., Inc., 135 West 50th St., New York, New York 10020; Orders to: VNR Order Processing, 7625 Empire Dr., Florence, Kentucky 41042.
- DeRenzo, D. H. 1978. Unit Operations for Treatment of Hazardous Industrial Wastes, Noyes Data Corp., Mill Road at Grand Avenue, Park Ridge, New Jersey 07656.
- Ghasseni, M., et al. 1981. "Feasibility of Commercialized Water Treatment Techniques for Concentrated Waste Spills," TRW Environmental Engineering Division, Redondo Beach, California, Report No. PB82-1-8440 or EPA-600/2-81-213. Available from National Technical Information Service, U.S. Department of Commerce, 5285 Port Royal Road, Springfield, Virginia 22161.
- Hammer, M. J. 1975. Water and Waste-Water Technology, John Wiley and Sons, 605 3rd Ave., New York, New York 10016.
- Hayward Baker Company, Earthtech Research Corp., and ENSCO, Inc. 1980. "Chemical Soil Grouting, Improved Design and Control," Federal Highway Administration, Fairbank Highway Research Station, 400 Seventh St., S.W., Washington, D.C. 20590.
- Liptak, B. G., ed. 1974. Environmental Engineer*s Handbook, Vol 1, Water Pollution, Chilton Book Co., School Library Services, Chilton Way, Radnor, Pennsylvania 19089.
- Lubowitz, H., Derham, R., Ryan, L., and Zakrsewski, G. 1977. "Development of a Polymeric Cementing and Encapsulating Process of Managing Hazardous Wastes," Prepared under Contract 68-03-2037 by TRW Systems Group for Environmental Protection Agency Municipal Environmental Research Laboratory, Office of Research and Development, Cincinnati, Ohio. Available from National Technical Information Service, U.S. Department of Commerce, 5285 Port Royal Road, Springfield, Virginia 22161.
- Lutton, R., Regan, G., and Jones, L. 1979. "Design and Construction of Covers for Solid Waste Landfills," EPA-600/2-79-165, Municipal Environmental Research Laboratory, Office of Research and Development,

- Cincinnati, Ohio. Available from National Technical Information Service, U.S. Department of Commerce, 5285 Port Royal Road, Springfield, Virginia 22161.
- Metry, Amir A. 1980. The Handbook of Hazardous Waste Management, Technomic, Westport, Connecticut 06880.
- Stanczyk, T. F., Senefelder, B. C., and Clarke, J. H. 1982. "Solidification/Stabilization Process Appropriate to Hazardous Chemicals and Waste Spills," 1982 Hazardous Materials Spills Conference, pp 79-84, Government Institutes Inc., 966 Hungerford Dr., No. 24, Rockville, Maryland 20850.
- U.S. Environmental Protection Agency. 1973. "Process Design Manual for Carbon Adsorption," U.S. Environmental Protection Agency Technology Transfer, EPA-625/1-7-022a. Available from National Technical Information Service, U.S. Department of Commerce, 5285 Port Royal Road, Springfield, Virginia 22161.
- U.S. Environmental Protection Agency. 1976. "Erosion and Sediment Control, Surface Mining in Eastern U.S., Vol 1: Planning; Vol 2, Design," EPA-625/3-76-006, EPA Technology Transfer, Washington, D.C. Available from National Technical Information Service, U.S. Department of Commerce, 5285 Port Royal Road, Springfield, Virginia 22161.
- U.S. Environmental Protection Agency. 1979. "Survey of Solidification/Stabilization Technology for Hazardous Industrial Sites," EPA-600/2-79-956, Cincinnati, Ohio. Available from National Technical Information Service, U.S. Department of Commerce, 5285 Port Royal Road, Springfield, Virginia 22161.
- U.S. Environmental Protection Agency. 1980. "Treatability Manual, Technologies for Control/Removal of Pollutants," EPA-600/8-80-042c, Office of Research and Development, Washington, D.C. Available from National Technical Information Service, U.S. Department of Commerce, 5285 Port Royal Road, Springfield, Virginia 22161.
- U.S. Environmental Protection Agency. 1982. "Handbook for Remedial Action at Hazardous Waste Disposal Sites," EPA-625/6-82-006, Cincinnati, Ohio. Available from National Technical Information Service, U.S. Department of Commerce, 5285 Port Royal Road, Springfield, Virginia 22161.
- U.S. Environmental Protection Agency. 1986. "Superfund Public Health Assessment Manual," EPA/540/1-86/060, Office of Solid Waste and Emergency Response Directive 9285.4-1, Office of Emergency and Remedial Response, 401 M. Street, NW, Washington, DC. Available from National Technical Information Service, U.S. Department of Commerce, 5285 Port Royal Road, Springfield, Virginia 22161.
- U.S. Environmental Protection Agency. 1987. "A Compendium of Superfund Field Operations Methods," EPA/540/P-87/001, Office of Solid Waste and Emergency Response Directive 9355.0-14, Office of Emergency and Remedial

Response, 401 M. Street, NW, Washington, DC. Available from National Technical Information Service, U.S. Department of Commerce, 5285 Port Royal Road, Springfield, Virginia 22161.

U.S. Environmental Protection Agency. 1988. "CERCLA Compliance with Other Laws Manual," EPA/540/G-89/006, Office of Solid Waste and Emergency Response Directive 9234.0-3, Office of Emergency and Remedial Response, 401 M. Street, NW, Washington, DC. Available from National Technical Information Service, U.S. Department of Commerce, 5285 Port Royal Road, Springfield, Virginia 22161.

U.S. Environmental Protection Agency. 1988. "Guidance on Conducting Remedial Investigations and Feasibility Studies Under CERCLA," EPA/540/G-89/004, Office of Solid Waste and Emergency Response Directive 9355.3-01, Office of Emergency and Remedial Response, 401 M. Street, NW, Washington, DC. Available from National Technical Information Service, U.S. Department of Commerce, 5285 Port Royal Road, Springfield, Virginia 22161.

U.S. Environmental Protection Agency. 1988. "Guidance on Remedial Actions for Contaminated Ground Water at Superfund Sites," EPA/540/G-88/003, Office of Solid Waste and Emergency Response Directive 9283.1-2, Office of Emergency and Remedial Response, 401 M. Street, NW, Washington, DC. Available from National Technical Information Service, U.S. Department of Commerce, 5285 Port Royal Road, Springfield, Virginia 22161.

U.S. Environmental Protection Agency. 1988. "Superfund Exposure Assessment Manual," EPA/540/1-88/001, Office of Solid Waste and Emergency Response Directive 9285.5-1, Office of Emergency and Remedial Response, 401 M. Street, NW, Washington, DC. Available from National Technical Information Service, U.S. Department of Commerce, 5285 Port Royal Road, Springfield, Virginia 22161.

U.S. Environmental Protection Agency. 1991. "Soil Vapor Extraction Technology Reference Handbook," EPA/540/2-91/003, Office of Emergency and Remedial Response, 401 M. Street, NW, Washington, DC. Available from National Technical Information Service, U.S. Department of Commerce, 5285 Port Royal Road, Springfield, Virginia 22161.

A-2. Related Publications.

a. Containment Technologies.

(1) Capping.

The Asphalt Institute. 1976 (Nov). "Asphalt in Hydraulics," Manual Series No. 12, The Asphalt Institute.

Brady, N. C. 1974. The Nature and Properties of Soils, 8th Ed., MacMillan, New York.

Brawner, C. O., Ed. 1980. First International Conference on Uranium Mine Waste Disposal, Society of Mining Engineers, Littleton, CO.

- Chamberlain, E. J., and Cow, A. J. 1979. "Effect of Freezing and Thawing on the Permeability and Structure of Soils," *Engineering Geology*, 13, Elsevier Scientific Publishing Co., Amsterdam, The Netherlands, pp 73-92.
- Daniel, D. E., and Liljestrant, H. M. 1984 (Jan). Effects of Landfill Leachates on Natural Liner Systems, Chemical Manufacturer*s Association.
- England, C. B. 1970. "Land Capability: A Hydrologic Response Unit in Agricultural Watersheds," ARS 41-172, Agricultural Research Service, U.S. Department of Agriculture.
- Ghassemi, M. 1983 (May). "Assessment of Technology for Constructing and Installing Cover and Bottom Liner Systems for Hazardous Waste Facilities," Vol 1, EPA Contract No. 68-02-3174, work assignment No. 109, U.S. EPA.
- Kays, W. B. 1977. Construction of Linings for Reservoirs, Tanks, and Pollution Control Facilities, John Wiley & Sons, New York.
- Kmet, P., Quinn, K. J., and Slavik, C. 1981 (Sep). "Analysis of Design Parameters Affecting the Collection Efficiency of Clay Lined Landfills," University of Wisconsin Extension.
- Lambe, W. T., and Whitman, R. V. 1979. Solid Mechanics. SI Version, John Wiley and Sons, NY.
- Lutton, R. J. 1982. "Evaluating Cover Systems for Solid and Hazardous Waste," SW867 (Revised Edition), U.S. EPA, Washington, DC.
- Morrison, W. R., and Simmons, L. R. 1977. "Chemical and Vegetative Stabilization of Soil: Laboratory and Field Investigations of New Materials and Methods for Soil Stabilization and Erosion Control," Bureau of Reclamation Report No. 7613.
- Oldham, J. C., et al. 1977. "Materials Evaluated as Potential Soil Stabilizers," Miscellaneous Paper No. S-77-15, U.S. Army Engineer Waterways Experiment Station, Vicksburg, MS.
- Richards, L. A. 1965. "Physical Condition of Water in Soil," In: *Methods of Soil Analysis*, C. A. Black, Ed., American Society of Agronomy, Inc.
- Schroeder, P. R., et al. 1984. "The Hydrologic Evaluation of Landfill Performance (HELP) Model," Vol 1, EPA/530-SW-84-009, U.S. EPA.
- Tchobanoglous, G., et al. 1977. Solid Wastes: Engineering Principles and Management Issues, McGraw-Hill, New York.
- U.S. EPA. "Construction Quality Assurance for Hazardous Waste Land Disposal Facilities," Public Comment Draft, J. C. Herrmann, Project Officer, EPA/530-SW-85-021.

EM 1110-1-502
30 Apr 94

U.S. EPA. 1982 (July). Draft RCRA Guidance Document Landfill Design, Liner Systems and Final Cover.

U.S. EPA. 1983. "Lining of Waste Impoundment and Disposal Facilities. SW870.

U.S. EPA. "Procedures for Modeling Flow Through Clay Liners to Determine Required Liner Thickness," EPA/530-SW-84-001.

Warner, R. C., et al. "Demonstration and Evaluation of the Hydrologic Effectiveness of a Three Layer Landfill Surface Cover Under Stable and Subsidence Conditions," Phase I, Final Project Report.

Warner, R. C., et al. 1984. "Multiple Soil Layer Hazardous Waste Landfill Cover: Design, Construction, Instrumentation and Monitoring, In: Land Disposal of Hazardous Waste, Proceedings of the Tenth Annual Research Symposium.

(2) Dust controls.

Ritter, L. J., Jr., and Paquette, R. J. 1967. Highway Engineering, 3rd Ed., The Ronald Press Co., New York, pp 726-728.

(3) Horizontal barriers.

Bureau of Reclamation. "Pressure Grouting," Technical Memo 646.

U.S. EPA. Handbook for Evaluating Remedial Action Technology Plans.

(4) Sediment control barriers.

California Department of Conservation. 1978 (May). Erosion and Sediment Control Handbook, Department of Conservation, State of California.

U.S. EPA. 1972 (Aug). "Guidelines for Erosion and Sediment Control Planning and Implementation," Environmental Protection Technical Services.

U.S. EPA. 1978 (Sep). "Management of Bottom Sediment Containing Toxic Substance Procedure," 3rd U.S. -Japan Meeting.

U.S. EPA. 1982 (Jun). "Handbook, Remedial Action at Waste Disposal Sites," EPA-625/6-6-82-006, Cincinnati, OH.

(5) Surface controls.

U.S. EPA. 1982 (Jul). "Draft RCRA Guidance Document Landfill Design, Liner Systems, and Final Cover."

(6) Vertical barriers.

Bureau of Reclamation. "Pressure Grouting," Technical Memo. 646.

Shuster, J. 1972. "Controlled Freezing for Temporary Ground Support," Proceedings. 1st North American Rapid Excavation and Tunneling Conference.

Xanthakos, P. Slurry Walls, McGraw Hill, New York.

b. Treatment Technologies.

(1) Air emission controls/gas treatment.

Bonner, T., et al. 1981. Hazardous Waste Incineration Engineering, Noyes Data Corp., Park Ridge, NJ.

Kern, D. Q. 1950. Process Heat Transfer, McGraw-Hill, New York.

Kohl, A., and Riesenfeld, F. 1979. Gas Purification, Gulf Publishing Co.

Perry and Chilton. 1973. Chemical Engineers* Handbook, 5th Ed., McGraw-Hill, New York.

Research and Education Association. 1978. "Modern Pollution Control Technology," Vol 1, Air Pollution Control.

(a) Biological treatment.

Benfield, L. D., and Randall, C. W. 1980. Biological Process Design for Wastewater Treatment, Prentice-Hall, Englewood Cliffs, NJ.

Clark, J. W., Viessman, W., Jr., and Hammar, J. 1977. Water Supply and Pollution Control, IEP, Dun-Donnelly, New York.

Eckenfelder, W., Jr. 1980. Principles of Water Quality Management, CBI Publishing, Boston.

Fair, G., Geyer, J., and Okun, D. 1968. Water and Wastewater Engineering, Vol 2, John Wiley, New York.

Junkins, R., et al. 1983. The Activated Sludge Process: Fundamentals of Operation, Ann Arbor Science Publishers, Ann Arbor, MI.

Manual of Practice No. 16, Anaerobic Sludge Digestion. 1968. W PCF.

Metcalf & Eddy. 1972. Wastewater Engineering: Treatment. Disposal. Reuse, 2nd Ed., McGraw-Hill, New York.

Overcash. 1979. Design of Land Treatment Systems for Industrial Wastes.

Shreve, R. N., and Brink, J. A., Jr. 1977. Chemical Process Industries, McGraw-Hill, New York.

Smith, E. D., et al. 1980. Proceedings First National Symposium/Workshop, Rotating Biological Contractor Technology, University of Pittsburgh.

EM 1110-1-502
30 Apr 94

- Speece, R. E., and Malina, J. F., Jr., Eds. 1973. Applications of Commercial Oxygen to Water and Wastewater Systems, University of Texas, Austin.
- U.S. EPA. 1985 (Dec). "Guide for Identifying Cleanup Alternatives at Hazardous-Waste Sites and Spills," EPA/600/3-83-063; NTIS PB86-144664.
- U.S. EPA. 1980. "Hazardous Waste Land Treatment," EPA SW 874.
- U.S. EPA. 1984 (Dec). "Permit Guidance Manual on Hazardous Waste Land Treatment Demonstrations," Draft, EPA 530-SW-84-015.
- U.S. EPA. Process Design Manual. Sludge Treatment and Disposal.
- U.S. Municipal Environmental Research Laboratory. 1983 (Oct). "Process Design Manual for Land Application of Municipal Sludge," EPA 625/1-83-016, U.S. EPA.
- Vesilind, P. A. Sludge Treatment and Disposal.
- (b) Chemical treatment.
- Audrieth, L. F., and Ogg, B. A. 1951. The Chemistry of Hydrazine, John Wiley, New York.
- Berkowitz, J. B., et al. 1978. Unit Operations for Treatment of Industrial Wastes, Noyes Data Corp., Park Ridge, NJ.
- Butler, J. W. 1964. Solubility and pH Calculations, Addison-Wesley.
- Duffey, J. C., Gale, S. B., and Bruckenstein, S. "Electrochemical Removal of Chromates and Other Metals," In: Cooling Towers, Vol 2, pp 44-50.
- McHugh, M. A., and Krukonis, V. J. 1986. Supercritical Fluid Extraction Principles and Practice, Butterworth Publishers, Boston.
- Metcalf & Eddy, Inc., revised by Tchobanoglous, C. 1979. Wastewater Engineering: Treatment. Disposal. Reuse. 2nd Ed.
- Reduction by Direct Current (Electrochemical Treatment) References: Scull, G. W., and Uhrich, K. D. "Electrochemical Removal of Heavy Metals in the Presence of Chelating Agents," Andco Environmental Processes, Inc., Amherst, New York.
- Simpson, D. K. 1983 (Oct). "Safety Handling Hydrazine," prepared for the Water Industrial Power Conference, Southfield, MI.
- Tsusita, R. A., et al. 1981. "Pretreatment of Industrial Wastes, Manual of Practice," No.FD-3, Water Pollution Control Federation, Washington, DC.
- (2) In situ treatment.

- Ahlert, R. C., and Kosson, D. S. In-Situ and On-Site Biodegradation of Industrial Landfill Leachate, NTIS, Springfield, VA.
- American Petroleum Institute. 1982 (Feb). Enhancing the Microbial Degradation of Underground Gasoline by Increasing Available Oxygen, Texas Research Institute.
- American Petroleum Institute. 1985. "Feasibility Studies on the Use of Hydrogen Peroxide to Enhance Microbial Degradations of Gasoline," API Publication 4389.
- Baker, R., et al. 1986 (Oct). "In Situ Treatment for Site Remediation," paper presented at Third Annual Hazardous Waste Law and Management Conference, Seattle, WA, and Portland, OR.
- Cheremisinoff, N. , and Azbel, D. 1983. Liquid Filtration, Science Publishers, Ann Arbor, MI.
- Cheremisinoff, P. N., and Ellerbusch, F. 1980. Carbon Adsorption Handbook, Science Publishers, Ann Arbor, MI.
- Dodds, R. A., and Cohen, J. M. 1980 (Apr). "Carbon Adsorption Isotherms for Toxic Organics," EPA-600/8-80-023, U.S. EPA.
- Ellis, W. D., and Fogg, T. R. 1986 (Aug). "Treatment of Soils Contaminated With Heavy Metals," EPA/600/9-86/022, U.S. EPA, pp 201-207.
- Flathman, P. E., and Caplan, J. A. 1985 (Apr). "Biological Cleanup of Chemical Spills," paper presented at Hazmacon '85 Conference, Oakland, CA.
- Gosset, J. M., et al. 1985 (Jun). "Mass Transfer Coefficients and Henry*s Constants for Packed-Tower Air Stripping of Volatile Organics: Measurement and Correlation," ESL-TR-85-18, Final Report, U.S. Air Force.
- Kavanaugh, M. C., and Trussel, R. R. 1980 (Dec). "Design of Aeration Towers to Strip Volatile Contaminants from Drinking Water," Journal AWWA.
- Modern Pollution Control Technology. 1978. Vol 2, Water Pollution Control, Research and Education Association.
- Nyer, E. K. 1985. "Treatment Methods for Organic Contaminants: Biological Methods - In Situ Treatment," Groundwater Treatment Technology, Van Nostrand Reinhold, pp 10-108.
- Perry and Chilton. 1973. Chemical Engineers* Handbook, 5th Ed., McGraw-Hill, New York.
- Schweitzer, P. A. 1979. Handbook of Separation Techniques for Chemical Engineers, McGraw-Hill, New York.

EM 1110-1-502
30 Apr 94

Shukla, Harish M., and Hicks, R. E. 1984. "Process Design Manual for Stripping of Organics," EPA/600-/2-84-130, U.S. EPA.

Treybal, R. 1983. Mass Transfer Operations, 3rd Ed., McGraw-Hill, New York.

U.S. EPA. 1985. "In Situ Treatment - Bioreclamation," Remedial Action at Waste Disposal Sites, Revised, EPA/625/6/-85/006.

U.S. EPA. 1984 (Sept/Nov). "Review of In-Place Treatment for Contaminated Surface Soils," Vol 1, Technical Evaluation, Vol 2, Background Information for In Situ Treatment, EPA-540/2-84-003a and EPA-540/284-003b, (NTIS PB-124881 and PB-124899).

Ward, C. H., and Lee, M. D. 1985. "In Situ Technologies," Groundwater Pollution Control, Canter and Knox, Eds., Lewis Publishers.

Wetzel, R. S., et al. 1986 (Aug). "Field Demonstration of In Situ Biological Treatment of Contaminated Groundwater and Soils," EPA/600/9-86/022, U.S. EPA, pp 146-160.

Yaniga, P. M., and Sanith, W. 1984. "Aquifer Restoration via Accelerated In Situ Biodegradation of Organic Contaminants." Proceedings. NWWA/API Conference on Petroleum Hydrocarbons and Organic Chemicals in Groundwater Prevention, Detection, and Restoration, pp 451-470.

(3) Solids dewatering.

Metcalf and Eddy, Inc. 1972. Wastewater Engineering: Collection, Treatment, Disposal, McGraw-Hill, New York.

Perry and Chilton. 1973. Chemical Engineer*s Handbook, 5th Ed., McGraw-Hill, New York.

Research and Education Association. 1978. "Modern Pollution Control Technology," Vol II, Solid Waste Disposal.

(4) Solids processing.

Given, I. A. 1973. Mining Engineering Handbook, Society of Mining Engineers, New York.

Taggart, A. F. 1951. Elements of Ore Dressing. John Wiley, New York.

Technical Handbook for Stabilization/Solidification Alternatives for Remedial Action at Uncontrolled Hazardous Waste Sites. 1986. Environmental Laboratory, U.S. Army Engineer Waterways Experiment Station, Vicksburg, MS.

U.S. EPA. 1982 (Sept). "Guide to the Disposal of Chemically Stabilized and Solidified Waste," EPA Doc. No. SW-872. Municipal Environmental Research Laboratory, Cincinnati, OH.

- U.S. EPA. 1982 (Jun). "Remedial Action at Waste Disposal Sites," Municipal Environmental Research Laboratory, Cincinnati, OH.
- (5) Thermal treatment.
- Ahling, B. 1979 (May). "Destruction of Chlorinated Hydrocarbons in a Cement Kiln," Environmental Science and Technology, Vol 13, No. 11.
- Brunner, C. R. 1984. Incineration Systems Selection and Design," Van Nostrand Reinhold, New York.
- Environment Canada, Environmental Protection Service, Environmental Impact Control Directorate, Waste Management Branch. 1982. Destruction Technologies for Polychlorinated Biphenyls (PCBs). Based on a report to the Waste Management Branch by M. M. Dillon Ltd., Consulting Engineers and Planners, Toronto, Ontario, Canada.
- Frankel, I., Sanders, N., and Vogel, G. 1983 (Mar). Survey of the Incineration Manufacturing Industry. CEP.
- Lauber, J. D. 1982 (Jul). "Burning Chemical Wastes as Fuels in Cement Kilns," Journal of the Air Pollution Control Association, Vol 32, No. 7.
- McBride, J. L., and Heimback, J. A. 1982 (Jul). "Skid Mounted System Gives California Hazardous Wastes Hot Time," Pollution Engineering.
- McCarthy, J. J. 1982 (Feb). "Technology Assessment of the Vertical Well Chemical Reactor," EPA-600/2-82-005, prepared for U.S. EPA, Municipal Environmental Research Laboratory, Office of Research and Development.
- Oberacker, D. A. 1984. "Hazardous Waste Incineration Performance Evaluations by the United States Environmental Protection Agency," EPA-600/D-84-285, prepared for U.S. EPA, Cincinnati, OH.
- Peters, J. A., Hughes, T. W., and Mourninghan, R. E. 1983. Evaluation of Hazardous Waste Incineration in a Cement Kiln at San Juan Cement, Monsanto Research Co., Dayton, OH.
- Seebold, J. A. 1984 (Dec). "Practical Flare Design," Chemical Engineering,
- U.S. Congress, Office of Technology Assessment, Industry, Technology, and Employment Program. 1985. Superfund Strategy-Preventing a Toxic Tomorrow.
- U.S. EPA. 1981 (Sept). "Engineering Handbook for Hazardous Waste Incineration," NTIS Report No. P881-248163, prepared for U.S. EPA by Monsanto Research Corp. Dayton, OH.
- Weltzman, L. 1983. "Cement Kilns as Hazardous Waste Incinerators," Environmental Progress, Vol 2, No. 1.
- Wilhelmi, A. R., and Knopp, P. V. 1979 (Aug). Wet Air Oxidation - An Alternative to Incineration, CEP.

EM 1110-1-502
30 Apr 94

Williams, I. M., Jr. 1982. "Pyrolytic Incineration Destroys Toxic Wastes, Recovers Energy, Pollution Engineering.

Zanetti, W. J. 1983 (Dec). "Plasma: Warming Up to New CPI Applications," Chemical Engineering.

c. Removal/Collection Technologies.

(1) Clean/replace contaminated water and sewer lines.

Cleaning Pipelines: A Pigging Primer. 1985 (Feb). Chemical Engineering.

U.S. EPA. 1983 (Oct). "Demonstration of Sewer Relining by the Insituform Process, Northbrook, IL." EPA-600/2-83-064.

WPCF. 1980. "Operation and Maintenance of Wastewater Collection Systems," Manual of Practice No. 7.

(2) Drum and debris removal.

U.S. EPA. 1982 (Jun). "Handbook, Remedial Action at Waste Disposal Sites," EPA-625-6-6-82-006, Cincinnati, OH.

(3) Enhanced removal.

Donaldson, E. C., Chilingarian, C. U., and Ven, T. F. 1985. Enhanced Oil Recovery. Fundamentals and Analyses, 1, Elsevier Science Publishers B.V., Amsterdam, The Netherlands.

H. K. Van Poolen and Assoc., Inc. 1980. Enhanced Oil Recovery, Pennwells Publishing Company, Tulsa, OK.

Koltuniak, D. L. 1986 (Aug). "In Situ Air Stripping Cleans Contaminated Soils," Chemical Engineering, pp 30-31.

Patton, C. C. 1981. Oilfield Water Systems. Norman, Oklahoma, Campbell Petroleum Series.

Peurifoy, R. L. 1970. Construction Planning, Equipment and Methods, 2nd Ed., McGraw-Hill, New York. (Somewhat dated but a good overview of solids handling equipment.)

Schumacher, M. 14., Ed. 1980. Enhanced Recovery of Residual and Heavy Oils, Noyes Data Corp., Park Ridge, NJ. (Contains references.)

(4) Gas collection.

Argonne National Laboratory. 1982 (Feb). "Environmental Impacts of Sanitary Landfills and Associated Gas Recovery Systems," (ANL/CNSV-27), Argonne National Laboratory, Argonne, IL.

Bureau of Reclamation. 1978. Drainage Manual, U.S. GPO, Washington, DC, 286 pp.

- Bureau of Reclamation. 1981. Groundwater Manual, 2nd Ed., U.S. GPO, Washington, DC, 480 pp.
- Emcon Associates. 1980. Methane Generation and Recovery from Landfills, Science Publishers, Ann Arbor, MI.
- Freeze, et al. 1979. Groundwater, Prentice-Hall Inc., Englewood Cliffs, NJ.
- Johnson Division, UOP, Inc. 1975. Groundwater and Wells, Johnson Division, UOP, Inc., Saint Paul, MN.
- Landfill Methane Recovery. 1983. Energy Technology Review #80, Noyes Data Corp.
- Tchobanoglous, Theisen, and Eliassen. 1977. Solid Wastes - Engineering Principles and Management Issues, McGraw-Hill, New York.
- U.S. Army. 1971. "Dewatering: Groundwater Control for Deep Excavations," Technical Manual No. 5-818-5, prepared by the U.S. Army Engineer Waterways Experiment Station.
- U.S. Department of Agriculture. 1971. "Section 16, Drainage of Agricultural Land," in SCS National Engineering Handbook, Engineering Division, Soil Conservation Service, Washington, DC.
- U.S. EPA. 1982 (June). "Handbook for Remedial Action at Waste Disposal Sites (Revised)," EPA-625/6-85/006, prepared by Hazardous Waste Engineering Research Laboratory, Cincinnati, OH.
- U.S. EPA. RCRA Groundwater Monitoring Technical Enforcement Guidance Document (TEGD).
- d. Disposal technologies.
- (1) Atmospheric discharge.
- GCA Corp. 1984 (Dec). "Evaluation and Selection of Models for Estimating Air Emissions from Hazardous Waste Treatment, Storage and Disposal Facilities," EPS-450/3-84-020.
- Kohl, A., and Riesenfeld, F. 1979. Gas Purification, 3rd Ed., Gulf Publishing Co.
- Vogel, C. 1985 (May). "Air Emission Control at Hazardous Waste Management Facilities," Journal of the Air Pollution Control Association.
- (2) Waste-water discharge.
- Florida Department of Environmental Regulation. 1981 (Apr). Class V Injection Well Inventory.

EM 1110-1-502
30 Apr 94

U.S. EPA. 1977 (Dec). "An Introduction to the Technology of Subsurface Wastewater Injection," EPA-600/2-77-240, prepared for the U.S. EPA by Don L. Warner, University of Missouri-Rolla and Jay H. Lehr, National Water Well Association.

U.S. EPA. 1982 (Sept). "Fate of Priority Pollutants in Publicly Owned Treatment Works," Vol I and II, EPA 440/1-82/303, U.S. EPA, Water and Waste Management Series, Effluent Guidelines Division WH-522.

U.S. EPA. 1980 (Jul). "Treatability Manual, Volume Treatability Data," EPA-600/8-80-042a, U.S. EPA Research and Development Series.

Versar, Inc. 1979 (Dec). "Water-Related Environmental Fate of 129 Priority Pollutants," Vol I and II, NTIS PB80-204381, Versar, Inc., Springfield, VA. Prepared for U.S. EPA, Washington, DC.

APPENDIX B

MODEL STATEMENT OF WORK FOR CONDUCTING AN RI/FS

B-1. Purpose.

a. The purpose of this remedial investigation/feasibility study (RI/FS) is to investigate the nature and extent of contamination at the (Name of Site) and to develop and evaluate remedial alternatives, as appropriate. The contractor will furnish all necessary personnel, materials, and services needed for, or incidental to, performing the RI/FS, except as otherwise specified herein. The contractor will conduct the RI/FS in accordance with the Guidance for Conducting Remedial Investigations and Feasibility Studies Under CERCLA (U.S. EPA, October 1988).

b. This statement of work (SOW) has been developed for the (Name of Site) that operated as a [Briefly Describe Site].

B-2. Scope.

a. The specific RI/FS activities to be conducted at the (Name of Site) are segregated into 11 separate tasks.

- (1) Task 1 - Project Planning
- (2) Task 2 - Community Relations
- (3) Task 3 - Field Investigations
- (4) Task 4 - Sample Analysis/Validation
- (5) Task 5 - Data Evaluation
- (6) Task 6 - Risk Assessment
- (7) Task 7 - Treatability Studies
- (8) Task 8 - RI Report(s)
- (9) Task 9 - Remedial Alternatives Development and Screening
- (10) Task 10 - Detailed Analysis of Alternatives
- (11) Task 11 - FS Report(s)

b. The contractor will specify a schedule of activities and deliverables, a budget estimate, and staffing requirements for each of the tasks which are described below.

B-3. Task 1 Project Planning.

a. Upon receipt of an interim authorization memorandum (used to authorize work plan preparation) and this SOW from [Engineer District] outlining the general scope of the project, the contractor will begin planning the specific RI/FS activities that will need to be conducted. As part of this planning effort, the contractor will compile existing information (e.g., topographic maps, aerial photographs, data collected as part of the NPL listing process, and data collected as part of the drum removal of 1982) and conduct a site visit to become familiar with site topography, access routes, and the proximity of potential receptors to site contaminants. Based on this information (and any other available data), the contractor will prepare a site background summary that should include the following:

(1) Local Regional Summary - A summary of the location of the site, pertinent area boundary features and general site physiography, hydrology, geology, and the location(s) of any nearby drinking water supply wells.

(2) Nature and Extent of Problem - A summary of the actual and potential onsite and offsite health and environmental effects posed by any remaining contamination at the site. Emphasis should be on providing a conceptual understanding of the sources of contamination, potential release mechanisms, potential routes of migration, and potential human and environmental receptors.

(3) History of Regulatory and Response Actions - A summary of any previous response actions conducted by local, state, Federal, or private parties. This summary should address any enforcement activities undertaken to identify responsible parties, compel private cleanup, and recover costs. Site reference documents and their locations should be identified.

(4) Preliminary Site Boundary - A preliminary site boundary to define the initial area(s) of the remedial investigation. This preliminary boundary may also be used to define an area of access control and site security.

b. The contractor will meet with [Name of Engineer District] personnel to discuss the following:

(1) The proposed scope of the project and the specific investigative and analytical activities that will be required.

(2) Whether there is a need to conduct limited sampling to adequately scope the project and develop project plans.

(3) Preliminary remedial action objectives and general response actions.

(4) Potential remedial technologies and the need for or usefulness of treatability studies.

(5) Potential ARARs associated with the location and contaminants of the site and the potential response actions being contemplated.

(6) Whether a temporary site office should be set up to support site work.

c. Once the scope has been agreed upon with [Name of Engineer District], the contractor will: (1) develop the specific project plans to meet the objectives of the RI/FS and (2) initiate subcontractor procurement and coordination with analytical laboratories. [At some sites it may be necessary to submit an interim work plan initially until more is learned about the site. A subsequent, more thorough project planning effort can then be used to develop final work plans.] The project plans will include: a work plan which provides a project description and outlines the overall technical approach, complete with corresponding personnel requirements, activity schedules, deliverable due dates, and budget estimates for each of the

specified tasks; a sampling and analysis plan [composed of the field sampling plan (FSP) and the quality assurance project plan (QAPP)]; a health and safety plan (HSP); and a community relations plan (CRP).

d. The contractor will prepare a sampling and analysis plan (SAP) which will consist of the following:

(1) Field Sampling Plan. The FSP should specify and outline all necessary activities to obtain additional site data. It should contain an evaluation explaining what additional data are required to adequately characterize the site, conduct a baseline risk assessment, and support the evaluation of remedial technologies in the FS. The FSP should clearly state sampling objectives; necessary equipment; sample types, locations, and frequency; analyses of interest; and a schedule stating when events will take place and when deliverables will be submitted.

(2) Quality Assurance Project Plan. The QAPP should address all types of investigations conducted and should include the following discussions:

(a) A project description (should be duplicated from the work plan).

(b) A project organization chart illustrating the lines of responsibility of the personnel involved in the sampling phase of the project.

(c) Quality assurance objectives for data such as the required precision and accuracy, completeness of data, representativeness of data, comparability of data, and the intended use of collected data.

(d) Sample custody procedures during sample collection, in the laboratory, and as part of the final evidence files.

(e) The type and frequency of calibration procedures for field and laboratory instruments, internal quality control checks, and quality assurance performance audits and system audits.

(f) Preventative maintenance procedures and schedule and corrective action procedures for field and laboratory instruments.

(g) Specific procedures to assess data precision, representativeness, comparability, accuracy, and completeness of specific measurement parameters.

(h) Data documentation and tracking procedures.

(3) Health and Safety Plan - The contractor will develop an HSP on the basis of site conditions to protect personnel involved in site activities and the surrounding community. The plan should address all applicable regulatory requirements contained in 20 CFR 1910.120(i)(2) - Occupational Health and Safety Administration, Hazardous Waste Operations and Emergency Response, Interim Rule, December 19, 1986; U.S. EPA Order 1440.2 - Health and Safety Requirements for Employees Engaged in Field Activities; U.S. EPA Order 1440.3 - Respiratory Protection; U.S. EPA Occupational Health and Safety Manual; and U.S. EPA Interim Standard Operating Procedures (September 1982).

The plan should provide a site background discussion and describe personnel responsibilities, protective equipment, health and safety procedures and protocols, decontamination procedures, personnel training, and type and extent of medical surveillance. The plan should identify problems or hazards that may be encountered and how these are to be addressed. Procedures for protecting third parties, such as visitors or the surrounding community, should also be provided. Standard operating procedures for ensuring worker safety should be referenced and not duplicated in the HSP.

(4) Community Relations Plan - The contractor will prepare a community relations plan on how citizens want to be involved in the process based on interviews with community representatives and leaders. The CRP will describe the types of information to be provided to the public and outline the opportunities for community comment and input during the RI/FS. Deliverables, schedule, staffing, and budget requirements should be included in the plan.

e. The work plan and corresponding activity plans will be submitted to [Name of Engineer District] as specified in the contract or as discussed in the initial meeting(s). The contractor will provide a quality review of all project planning deliverables.

B-4. Task 2 Community Relations.

a. The contractor will provide the personnel, services, materials, and equipment to assist [Name of Engineer District] in undertaking a community relations program. This program will be integrated closely with all remedial response activities to ensure community understanding of actions being taken and to obtain community input on RI/FS progress. Community relations support provided by the contractor will include, but may not be limited to, the following:

(1) Revisions or additions to community relations plans, including definition of community relations program needs for each remedial activity.

(2) Establishment of a community information repository(ies), one of which will house a copy of the administrative record.

(3) Preparation and dissemination of news releases, fact sheets, slide shows, exhibits, and other audio-visual materials designed to apprise the community of current or proposed activities.

(4) Arrangements of briefings, press conferences, workshops, and public and other informal meetings.

(5) Analysis of community attitudes toward the proposed actions.

(6) Assessment of the successes and failures of the community relations program to date.

(7) Preparation of reports and participation in public meetings, project review meetings, and other meetings as necessary for the normal progress of the work.

(8) Solicitation, selection, and approval of subcontractors, if needed.

b. Deliverables and the schedule for submittal will be identified in the community relations plan discussed under Task 1.

B-5. Task 3 Field Investigations.

a. The contractor will conduct those investigations necessary to characterize the site and to evaluate the actual or potential risk to human health and the environment posed by the site. Investigation activities will focus on problem definition and result in data of adequate technical content to evaluate potential risks and to support the development and evaluation of remedial alternatives during the FS. The areal extent of investigation will be finalized during the remedial investigation.

b. Site investigation activities will follow the plans developed in Task 1. Strict chain-of-custody procedures will be followed and all sample locations will be identified on a site map. The contractor will provide management and QC review of all activities conducted under this task. Information from this task will be summarized and included in the RI/FS report appendixes. Activities anticipated for this site are as follows:

(1) Surveying and Mapping of the Site - Develop a map of the site that includes topographic information and physical features on and near the site. If no detailed topographic map for the site and surrounding area exists, a survey of the site will be conducted. Aerial photographs should be used, when available, along with information gathered during the preliminary site visit to identify physical features of the area. May be conducted under Task 1 as part of the site visit or limited investigation.

(2) Waste Characterization - Determine the location, type, and quantities as well as the physical or chemical characteristics of any waste remaining at the site. If hazardous substances are held in containment vessels, the integrity of the containment structure and the characteristics of the contents will be determined.

(3) Hydrogeologic Investigation - Determine the presence and potential extent of ground-water contamination. Efforts should begin with a survey of previous hydrogeologic studies and other existing data. The survey should address the soil*s retention capacity/mechanisms, discharge/recharge areas, regional flow directions and quality, and the likely effects of any alternatives that are developed involving the pumping and disruption of ground-water flow. Results from the sampling program should estimate the horizontal and vertical distribution of contaminants, and the contaminants* mobility and predict the long-term disposition of contaminants.

(4) Soils and Sediments Investigation - Determine the vertical and horizontal extent of contamination of surface and subsurface soils and sediments and identify any uncertainties with this analysis. Information on local background levels, degree of hazard, location of samples, techniques used, and methods of analysis should be included. If initial efforts indicate

that buried waste may be present, the probable locations and quantities of these subsurface wastes should be identified through the use of appropriate geophysical methods.

(5) Surface Water Investigation - Estimate the extent and fate of any contamination in the nearby surface waters. This effort should include an evaluation of possible future discharges and the degree of contaminant dilution expected.

(6) Air investigation - Investigate the extent of atmospheric contamination from those contaminants found to be present at the site. This effort should assess the potential of the contaminants to enter the atmosphere, local wind patterns, and the anticipated fate of airborne contaminants.

B-6. Task 4 Sample Analysis/Validation. The contractor will develop a data management system including field logs, sample management and tracking procedures, and document control and inventory procedures for both laboratory data and field measurements to ensure that the data collected during the investigation are of adequate quality and quantity to support the risk assessment and the FS. Collected data should be validated at the appropriate field or laboratory QC level to determine whether it is appropriate for its intended use. Task management and quality controls will be provided by the contractor. The contractor will incorporate information from this task into the RI/FS report appendixes.

B-7. Task 5 Data Evaluation. The contractor will analyze all site investigation data and present the results of the analyses in an organized and logical manner so that the relationships between site investigation results for each medium are apparent. The contractor will prepare a summary that describes (a) the quantities and concentrations of specific chemicals at the site and the ambient levels surrounding the site; (b) the number, locations, and types of nearby populations and activities; and (c) the potential transport mechanism and the expected fate of the contaminant in the environment.

B-8. Task 6 Risk Assessment.

a. The contractor shall conduct a baseline risk assessment to assess the potential human health and environmental risks posed by the site in the absence of any remedial action. This effort will involve four components: contaminant identification, exposure assessment, toxicity assessment, and risk characterization.

(1) Contaminant Identification - The contractor will review available information on the hazardous substances present at the site and identify the major contaminants of concern. Contaminants of concern should be selected based on their intrinsic toxicological properties because they are present in large quantities, and/or because they are currently in, or potentially may migrate into, critical exposure pathways (e.g., drinking water).

(2) Exposure Assessment - The contractor will identify actual or potential exposure pathways, characterize potentially exposed populations, and evaluate the actual or potential extent of exposure.

(3) Toxicity Assessment - The contractor will provide a toxicity assessment of those chemicals found to be of concern during site investigation activities. This will involve an assessment of the types of adverse health or environmental effects associated with chemical exposures, the relationships between magnitude of exposures and adverse effects, and the related uncertainties for contaminant toxicity (e.g., weight of evidence for a chemical*s carcinogenicity).

(4) Risk Characterization - The contractor will integrate information developed during the exposure and toxicity assessments to characterize the current or potential risk to human health and/or the environment posed by the site. This characterization should identify the potential for adverse health or environmental effects for the chemicals of concern and identify any uncertainties associated with contaminant(s), toxicity(ies), and/or exposure assumptions.

b. The risk assessment will be submitted to [Name of Engineer District] as part of the RI report.

B-9. Task 7 Treatability Studies.

a. The contractor will conduct bench and/or pilot studies as necessary to determine the suitability of remedial technologies to site conditions and problems. Technologies that may be suitable to the site should be identified as early as possible to determine whether there is a need to conduct treatability studies to better estimate costs and performance capabilities. Should treatability studies be determined to be necessary, a testing plan identifying the types and goals of the studies, the level of effort needed, a schedule for completion, and the data management guidelines should be submitted to [Name of Engineer District] for review and approval. Upon [Name of Engineer District] approval, a test facility and any necessary equipment, vendors, and analytical services will be procured by the contractor.

b. Upon completion of the testing, the contractor will evaluate the results to assess the technologies with respect to the goals identified in the test plan. A report summarizing the testing program and its results should be prepared by the contractor and presented in the final RI/FS report. The contractor will implement all management and QC review activities for this task.

B-10. Task 8 RI Report(s).

a. Monthly reports will be prepared by the contractor to describe the technical and financial progress at the (Name of Site). Each month the following items will be reported:

- (1) Status of work and the progress to date.
- (2) Percentage of the work completed and the status of the schedule.
- (3) Difficulties encountered and corrective actions to be taken.
- (4) The activity(ies) in progress.
- (5) Activities planned for the next reporting period.
- (6) Any changes in key project personnel.
- (7) Actual expenditures (including fee) and direct labor hours for the reporting period and for the cumulative term of the project.
- (8) Projection of expenditures needed to complete the project and an explanation of significant departures from the original budget estimate.

b. Monthly reports will be submitted to [Name of Engineer District] as specified in the contract. In addition, the activities conducted and the conclusions drawn during the remedial investigation (Tasks 3 through 7) will be documented in an RI report (supporting data and information should be included in the appendixes of the report). The contractor will prepare and submit a draft RI report to [Name of Engineer District] for review. Once comments on the draft RI report are received, the contractor will prepare a final RI report reflecting these comments.

B-11. Task 9 Remedial Alternatives Development and Screening.

a. The contractor will develop a range of distinct, hazardous waste management alternatives that will remediate or control any contaminated media (soil, surface water, ground water, sediments) remaining at the site, as deemed necessary in the RI, to provide adequate protection of human health and the environment. The potential alternatives should encompass, as appropriate, a range of alternatives in which treatment is used to reduce the toxicity, mobility, or volume of wastes but vary in the degree to which long-term management of residuals or untreated waste is required, one or more alternatives involving containment with little or no treatment; and a no-action alternative. Alternatives that involve minimal efforts to reduce potential exposures (e.g., site fencing, deed restrictions) should be presented as "limited action" alternatives.

b. The following steps will be conducted to determine the appropriate range of alternatives for this site:

(1) Establish Remedial Action Objectives and General Response Actions - Based on existing information, site-specific remedial action objectives to protect human health and the environment should be developed. The objectives should specify the contaminants(s) and media of concern, the exposure route(s) and receptor(s), and an acceptable contaminant level or range of levels for each exposure route (i.e., preliminary remediation goals). Preliminary

remedial action objectives are developed as part of the project planning phase.

(2) Preliminary remediation goals should be established based on readily available information (e.g., Rfds) or chemical-specific ARARs (e.g., MCLs). The contractor should meet with [Name of Engineer District] to discuss the remedial action objectives for the site. As more information is collected during the RI, the contractor, in consultation with [Name of Engineer District], will refine remedial action objectives as appropriate.

(3) General response actions will be developed for each medium of interest defining contaminant, treatment, excavation, pumping, or other actions, singly or in combination to satisfy remedial action objectives. Volumes or areas of media to which general response actions may apply shall be identified, taking into account requirements for protectiveness as identified in the remedial action objectives and the chemical and physical characteristics of the site.

(4) Identify and Screen Technologies - Based on the developed general response actions, hazardous waste treatment technologies should be identified and screened to ensure that only those technologies applicable to the contaminants present, their physical matrix, and other site characteristics will be considered. This screening will be based primarily on a technology*s ability to effectively address the contaminants at the site, but will also take into account a technology*s implementability and cost. The contractor will select representative process options, as appropriate, to carry forward into alternative development. The contractor will identify the need for treatability testing (as described under Task 7) for those technologies that are probable candidates for consideration during the detailed analysis.

(5) Configure and Screen Alternatives - The potential technologies and process options will be combined into media-specific or sitewide alternatives. The developed alternatives should be defined with respect to size and configuration of the representative process options; fine for remediation; rates of flow or treatment; spatial requirements; distances for disposal; and required permits, imposed limitations, and other factors necessary to evaluate the alternatives. If many distinct, viable options are available and developed, a screening of alternatives will be conducted to limit the number of alternatives that undergo the detailed analysis and to provide consideration of the most promising process options. The alternatives should be screened on a general basis with respect to their effectiveness, implementability, and cost. The contractor will meet with [Name of Engineer District] to discuss which alternatives will be evaluated in the detailed analysis and to facilitate the identification of action-specific ARARs.

B-12. Task 10 Detailed Analysis of Alternatives.

a. The contractor will conduct a detailed analysis of alternatives which will consist of an individual analysis of each alternative against a set of evaluation criteria and a comparative analysis of all options against the evaluation criteria with respect to one another.

b. The evaluation criteria are as follows:

(1) Overall Protection of Human Health and the Environment addresses whether or not a remedy provides adequate protection and describes how risks posed through each pathway are eliminated, reduced, or controlled through treatment, engineering or institutional controls.

(2) Compliance with ARARs addresses whether or not a remedy will meet all of the applicable or relevant and appropriate requirements of other Federal and state environmental statutes and/or provide grounds for invoking a waiver.

(3) Long-Term Effectiveness and Permanence refers to the ability of a remedy to maintain reliable protection of human health and the environment over time once cleanup goals have been met.

(4) Reduction of Toxicity, Mobility, or Volume Through Treatment is the anticipated performance of the treatment technologies a remedy may employ.

(5) Short-Term Effectiveness addresses the period of time needed to achieve protection and any adverse impacts on human health and the environment that may be posed during the construction and implementation period until cleanup goals are achieved.

(6) Implementability is the technical and administrative feasibility of a remedy, including the availability of materials and services needed to implement a particular option.

(7) Cost includes estimated capital and operation and maintenance costs, and net present worth costs.

(8) State Acceptance (Support Agency) addresses the technical or administrative issues and concerns the support agency may have regarding each alternative.

(9) Community Acceptance addresses the issues and concerns the public may have to each of the alternatives.

c. The individual analysis should include:

(1) A technical description of each alternative that outlines the waste management strategy involved and identifies the key ARARs associated with each alternative; and

(2) A discussion that profiles the performance of that alternative with respect to each of the evaluation criteria. A table summarizing the results of this analysis should be prepared. Once the individual analysis is complete, the alternatives will be compared and contrasted to one another with respect to each of the evaluation criteria.

B-13. Task 11 FS Report(s).

a. Monthly contractor reporting requirements for the FS are the same as those specified for the RI under Task 8.

b. The contractor will present the results of Tasks 9 and 10 in a FS report. Support data, information, and calculations will be included in appendixes to the report. The contractor will prepare and submit a draft FS report to [Name of Engineer District] for review. Once comments on the draft FS have been received, the contractor will prepare a final FS report reflecting the comments. Copies of the final report will be made and distributed to those individuals identified by [Name of Engineer District].